



GOLF COURSE EQUIPMENT

PARWEST ARE A PROUD DISTRIBUTOR OF TACIT



CONTENTS

Introduction	4-5
Our Sustainability Vision	6-7
Tee Markers	8-9
Hole Cutting	10-17
Hole Whitener	18-19
Flags	20-23
Flagsticks	24-27
Hickory	28-29
Holecups	30-33
Putting Green	34-35
Fine Turf Tools	36-39
Rakes	40-43
Water Removal	44-47
Eagle Feature	48-49



P44

DEW BRUSH (HARD)
1035



REJOINER
0919J

P36



EMBROIDERED FLAG
0806

P20

P10

SHOLÉ
HOLECUTTER
1013BCOM



USA ALUMINUM
FERRULE
0681

P24



P30

USA ALUMINUM
HOLECUP
0899PL



P15

HOLE CUTTING
BOARD & RINGS
1013HGPACK



INTRODUCTION

Tacit is a family owned and run business, with our key activities invested in the design, UK manufacturing and worldwide distribution of bespoke golf course equipment.

Tacit's unique vision is to be a growing, caring organization, while striving to achieve better results year-on-year. We achieve this by blending investment programs in all business activities, using modern equipment and systems with dedicated, experienced and skilled people in all areas.

Our vision is to be universally recognized as the market leader in the management and execution of all our activities by using:

- ★ **Our unique balance of commercial and technical expertise.**
- ★ **Our proven track record of excellent quality and service.**
- ★ **Our innovative delivery of value enhancing solutions to meet all our customers' needs.**

By working in partnership with superintendents and suppliers, we will continue to achieve world-class leadership in quality, engineering, design, delivery, service and management of all products.

We look forward to helping you become the best you can be.



A stylized, handwritten signature in white ink, consisting of the letters 'TW' followed by a period.

Tim Webb MA
President



TACIT
ALWAYS ON COURSE 

TACIT
ALWAYS ON COURSE 

TACIT
ALWAYS ON COURSE 



THE TACIT & EAGLE **SUSTAINABILITY** **VISION**

Tacit and Eagle are committed to shaping the future of golf with sustainability collectively at our core.

We are continually striving to improve design, manufacture, and delivery of our products and make choices that are fair and considerate for both people and the planet.

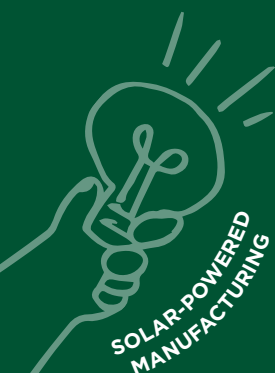

For more information, please visit:
www.tacitgolf.com/sustainability
and www.eagle.uk.com/sustainability

KEY ACTIONS AND INITIATIVES THAT SUPPORT OUR SUSTAINABILITY VISION



CARBON OFFSETTING

For over 35 years, founder Richard Webb has reduced our carbon footprint and supported biodiversity by planting trees and creating wildlife habitats.



HOLE CUP RECYCLING PROGRAM

This initiative encourages customers to return used cups for recycling, reducing waste and offering credit towards future purchases. (Only available in the UK.)



SOLAR-POWERED MANUFACTURING

We have installed solar panels on our UK factory to power our machines, which reduces our reliance on fossil fuels and lowers our carbon emissions.



SUSTAINABLE PACKAGING

We prioritize using recycled, recyclable, and biodegradable materials in our packaging and consolidate shipments wherever possible to minimize environmental impact.



ELECTRIC VEHICLE FLEET

We are transitioning our fleet to electric vehicles to reduce fossil fuel reliance, lower carbon emissions, and minimize our environmental impact.



RECYCLED FLAGS

We are proud to offer flags and tubes made from recycled plastic, including ocean plastic, helping reduce pollution and support vital ocean cleanup efforts.



ECO-FRIENDLY PAPER & BAMBOO

We use FSC-certified paper and bamboo, ensuring they come from responsibly managed, sustainable forests that protect biodiversity and reduce environmental impact.



RECYCLED MATERIALS

Our EaglePlex and Consolidated Lumber use recycled materials, lowering carbon footprints, reducing landfill waste, and offering maintenance-free durability to minimize resource consumption.



TEE MARKERS

AUGUSTA LOG TEE MARKER

A revolutionary slant on a traditional classic will add that touch of class to any tee. Made from recycled polymers, these wood effect logs never need to be painted, varnished or treated and will constantly look as good as the day they were purchased. Interchangeable end caps mean colors can be changed, refurbished or cleaned in an instant. Personalised branding ensures consistency throughout the course. The markers are held firmly in place by their stainless steel spikes.

WOODLAND TEE MARKER

An economical version of the Augusta, this Woodland Tee Marker is perfectly suited to parkland environments. Comes with a stainless steel spike, these markers add class to any course. Corporate images are easily applied thanks to Tacit's unique interchangeable face plate and all at an affordable price.

BESPOKE TEE MARKERS

Markers can be manufactured to any 2D design, laser cut to shape and then decaled to provide intricate detail as required. The design is only limited by your imagination. Let our Graphics department help you create a lasting impression on every tee.

CRYSTAL TEE CADDY

Made from clear polycarbonate, the Crystal Tee Caddy makes a subtle but visible impression on the tee. It is durable, designed to withstand the harshest conditions, with drainage holes underneath and a screw-in stainless steel spike to add stability.

AUGUSTA LOG TEE MARKER



0016C



0016C



0016G

WOODLAND TEE MARKER



0021L



0022L



0023L

BESPOKE TEE MARKERS



Cast Bronze



Forged Iron



Cut-Out Aluminum

CRYSTAL TEE CADDY





TACIT
SHOLÉ
HOLECUTTER



The Tacit Sholé Holecutter cuts an exact 4¼ inch hole every time with an integral hammer action.

With an upright operation and weighing less than 22lb, it is easy on the back utilising a unique and effortless core extraction system. The Sholé Holecutter has easily interchangeable compression (sand greens) and non-compression (clay greens) blades, with the accompanying board and rings providing a consistent depth every time. The bullseye spirit level acts as confirmation that every hole is cut level.

KEY FEATURES

- ★ No scalped or raised plugs.
- ★ Vertical cut (no back strain).
- ★ Perfectly round hole with crisp edges.
- ★ Consistent hole depth.
- ★ Allows easy plug extraction.
- ★ Only three bolts are needed to change the blades.
- ★ Shoe - protects the blade and stands the machine upright on the green.
- ★ Superfine blade for exact 4¼ inch cut.
- ★ Bolts act as a natural stop when using a cutting board.

SHOLÉ PARTS LIST

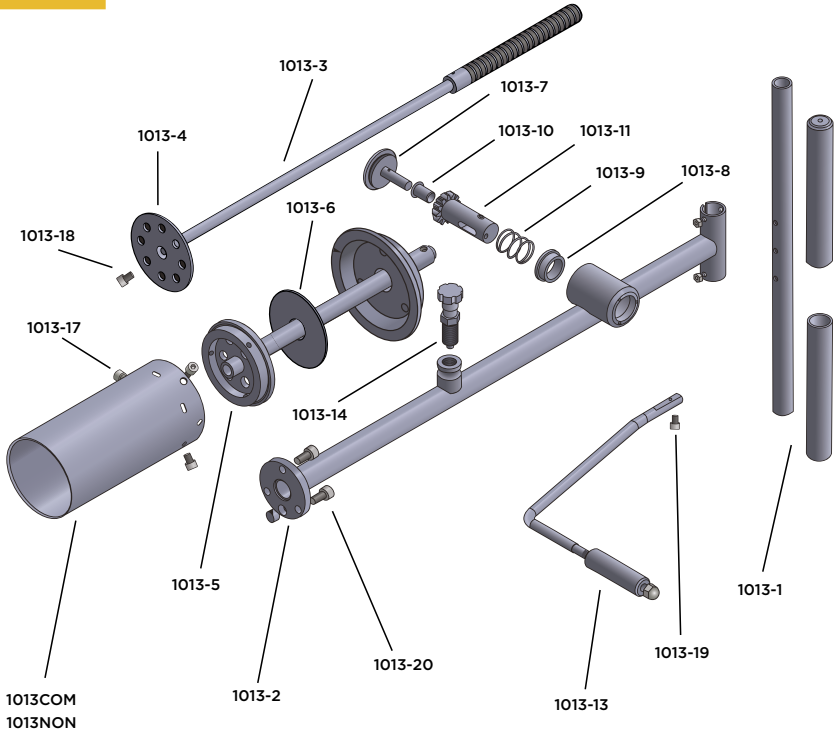

1013-1		Sponge Rubber Hand Grips and Handle
1013-2		Main Tube-Assembly
1013-3		Rack and Rack Shaft
1013-4		Ejector Disc
1013-5		Locking Tube - Assembly
1013-6		Poly Prop. Disc (Sound Deadening)
1013-7		Gear Box - Screw Cap
1013-8		Bearing - Modified
1013-9		Compression Spring
1013-10		Bearing

1013-11		Heavy Duty Pinion Gear
1013-13		Ejector Handle Grip
1013-14		Indexing Plunger ST Steel (Modified)
1013-15		Spirit Level
1013COM 1013NON		Blade - Compression or Non Compression
1013-17		Blade Bolt and Washer (Pack of 3)
1013-18		Sholé - Ejector Disc Bolt
1013-19		Sholé - Ejector Handle Bolt and Nut
1013-20		Sholé - Main Tube Assembly Bolt and Washer (Pack of 3)

CUTTING A HOLE



1
Remove the holecutter from the shoe and place in the board hole at the desired position on the green.



2
Release the hammer action by pulling out the indexing plunger and twisting 90 degrees.



3
Standing upright, lift the handle to extend the hammer and check the holecutter is vertical by means of the bullseye bubble level.



4
Make the first cut with a solid downward motion, letting go just before the hammer hits the blade. Adjust the angle using the bullseye bubble level.



Ensure the handles are released prior to impact to avoid jarring wrists and shoulders.



5
Repeat step three and four until the bolts reach the rings on the cutting board. This ensures the desired depth is reached.



6
Twist the indexing plunger back to its original position and line up the three red dots to lock the machine.

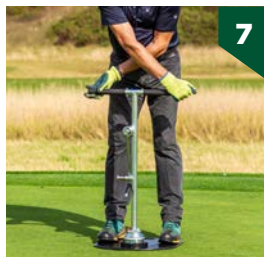

7
Make a 360 degree turn with the handle. This will ensure the core breaks cleanly and is easily removed.



8
Remove the core by lifting only with the arms and legs, keeping a straight back. Return the holecutter to its shoe.



HOLE CUTTING

SHOLÉ HOLECUTTER

One of Tacit's flagship products, the Sholé Holecutter, cuts an exact 4¼in hole every time with an integral hammer action.

Parts

Hole Cutting Board

Hole Cutting Rings

Compression Blade

Non-Compression Blade

Sholé Hole Cutter Shoe

HOLE CUTTING BOARD & RINGS

So simple it is brilliant. Interlocking rings are attached to the hole cutting board to give the precise depth of cut required. No guess work, every hole is cut exactly to the set depth, no more sunken or scalped old holes no matter which member of staff is cutting the holes.

SPRUNG LIFTER

A simple but effective tool, designed to easily remove holecups without damaging the surrounding turf.

ALUMINUM AND NYLON SETTERS

Designed to give the perfect depth for the holecup every time. Available in either aluminum or nylon.



SPRUNG LIFTER
0954



ALUMINUM SETTER (1½in)
0925



NYLON SETTER (1in)
0925N



SHOLÉ HOLECUTTER
1013BCOM



HOLE CUTTING BOARD & RINGS
1013HGPACK



HOLE CUTTING

GREENKEEPERS' BUCKET

The ideal place to store all the tools required for hole cutting. Easy to carry and with no sharp edges to damage or mark the green; tools are always handy. The central area can also be used for storing seed and top dressing for any emergency repairs.

GREENKEEPERS' SCISSORS

Curved sharp-bladed scissors for use with hole preparation. They work perfectly in conjunction with the curvature of any holecup.

NANO GAUGE

A lightweight and pocket sized hole gauge for use prior to and during tournaments for setting the cup and also assuring the hole is always the correct shape and size.

Machined to an exact 4¼in diameter and 1in depth, from a solid aluminum block, the hand gauge can instantly be used to correct the size and shape of the hole.

The Tacit Nano Gauge is used by referees at major tour events.

“Tacit’s Nano Gauge is a precision tool which has been an invaluable help at re-setting damaged holes to the exact size during our event. It’s lightweight and fits easily into my pocket.”

James Crampton

Director of Championships, England Golf



GREENKEEPERS' BUCKET
0937



GREENKEEPERS' SCISSORS
0929



NANO GAUGE
0925NANO

TACIT HOLE WHITENER



HOLE WHITENER FEATURES

- ★ High quality paint
- ★ Super bright
- ★ Fast drying formula
- ★ Harmless to soil and turf



The essential tool for creating a professional finish to your hole cups in seconds.

Golfers need clear, visible holes for a better putting experience, and the Tacit Hole Whitener delivers just that. Combining Tacit's Hole Whitener Paint and Applicator, greenkeepers can enhance the appearance of holes with bright, clean edges after every cup is set.

Once reserved for tournaments and special events, this quick and easy solution is now a must-have for everyday courses. With just seconds to apply, it dries fast and won't harm the soil or turf, giving your greens a pristine, professional look every time.

HOLE WHITENER APPLICATOR FEATURES

- ★ **Improves target visibility:** Helps golfers see the hole clearly, boosting their on-green experience.
- ★ **Quick application:** Achieve a professional finish in just seconds.
- ★ **Mess-Free:** Apply without creating any mess or start/stop dribbles.
- ★ **Ergonomic design:** Comfortable to handle, stands upright for easy application.
- ★ **Consistent coverage:** Delivers even, reliable coverage every time.



TACIT FLAGS

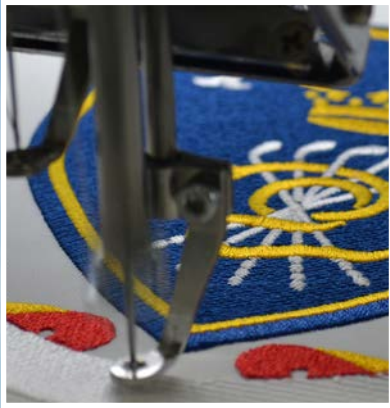

Tacit's dedicated commitment to exceptional workmanship is epitomized in our renowned logo flags.

These flags represent not just a symbol but a testament to our strong work ethic. With a team of skilled in-house graphic designers, we have the capacity to bring your visions to life, whether it is your club logo or a special event design.

What sets our logo flags apart is not just their superior craftsmanship, but the opportunity for customization to make them uniquely yours. Additionally, our logo flags can seamlessly integrate with your club's flagstick fitting, elevating the elegance of your golf course or event to a whole new level of sophistication.

"Simply the best logo flags on the market"

According to John Reilly at
The Resort at Longboat Key Club.



FLAGS

EMBROIDERED 0806

- ★ Stitched logo on nylon flag
- ★ Large eye-catching designs
- ★ Double sided
- ★ Readable on both sides
- ★ Anti-fungal material
- ★ Short turnaround times
- ★ Superior quality

SCREEN PRINT 077120

- ★ Ink printed onto nylon
- ★ Traditional printing method
- ★ Ink is ingrained into the material
- ★ Vibrant colors
- ★ Sharp images
- ★ Reads correctly from both sides
- ★ Excellent for television events

EASY PRINT 0742D

- ★ Ink printed by machine and heat cured onto knitted polyester
- ★ Short turnaround times
- ★ Double sided
- ★ Ideal event flags
- ★ Lightweight



FLORIDA KEY
0895FK

TUBE FLAGS

The Tube Flag has become the benchmark for USGA specification flagsticks. Crafted from premium materials and featuring Tacit's hallmark four-stitched leading edge, our Tube Flag sets the industry standard.

What sets our Tube Flag apart is the inclusion of a stitched flange, ensuring unmatched visibility and durability. Securing the tube flag is effortless, thanks to Tacit's distinctive Turret Nut, which can be tightened by hand, screwdriver, or spanner for your convenience.

PIN PLACEMENT FLAGS

Made to Tacit's exacting standards and manufactured in a variety of colors, Tacit's Pin Placement Flags are available plain or with a request to repair pitchmarks.

FLORIDA KEY

Tacit has finally solved the problem of lost or cross threaded nuts on the flag pins.

Unique key way design: Protruding nodes are set opposite and staggered to each other, which correspond to notches in the flag tube. This ensures the flag can be easily removed in seconds and replaced just as quickly.

Time saving: Clubs that run the three color pin placement indicator system can save on average four minutes per flag change.

Quick flag replacement: Replacing the flag is a quick process, involving sliding it over the pin and giving it two 180 degree twists to secure it back in place.

Wind resistance: If the flag should ride up in high winds it has to swivel another 180 degrees to come off and will usually return to its original position.

Compatibility: It is threaded to fit all existing top ferrules, making acorn nuts or turret nuts obsolete.

Maintenance-free: The Florida Key is solid and has no moving parts, eliminating the risk of malfunctions, soil jamming, or parts breaking.

1. Rotate

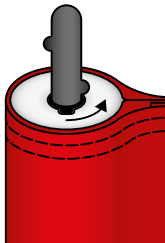

2. Lift



3. Rotate



4. Lift



5. Remove

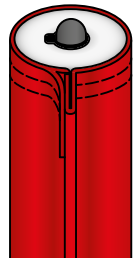



FLAGSTICKS

TACIT'S USA SPECIFICATION FLAGSTICKS

Tacit can now offer their latest range of high visibility American style flagsticks with tube flags. The high visibility flagstick is long lasting due to the high grade fiberglass and use of Tacit's locking ferrule and holecup system. This prevents excessive wear and stops the flagstick from rotating, leaning or blowing out. Comes complete with USA Ferrule and Turret Nut.

N.B. Florida Flagsticks come complete with aluminum ferrules as standard.



**USA NYLON
FERRULE**
0680



**USA ALUMINUM
FERRULE**
0681



TURRET NUT
0895

**THREADED USA
FLAGPIN TOP**
0896

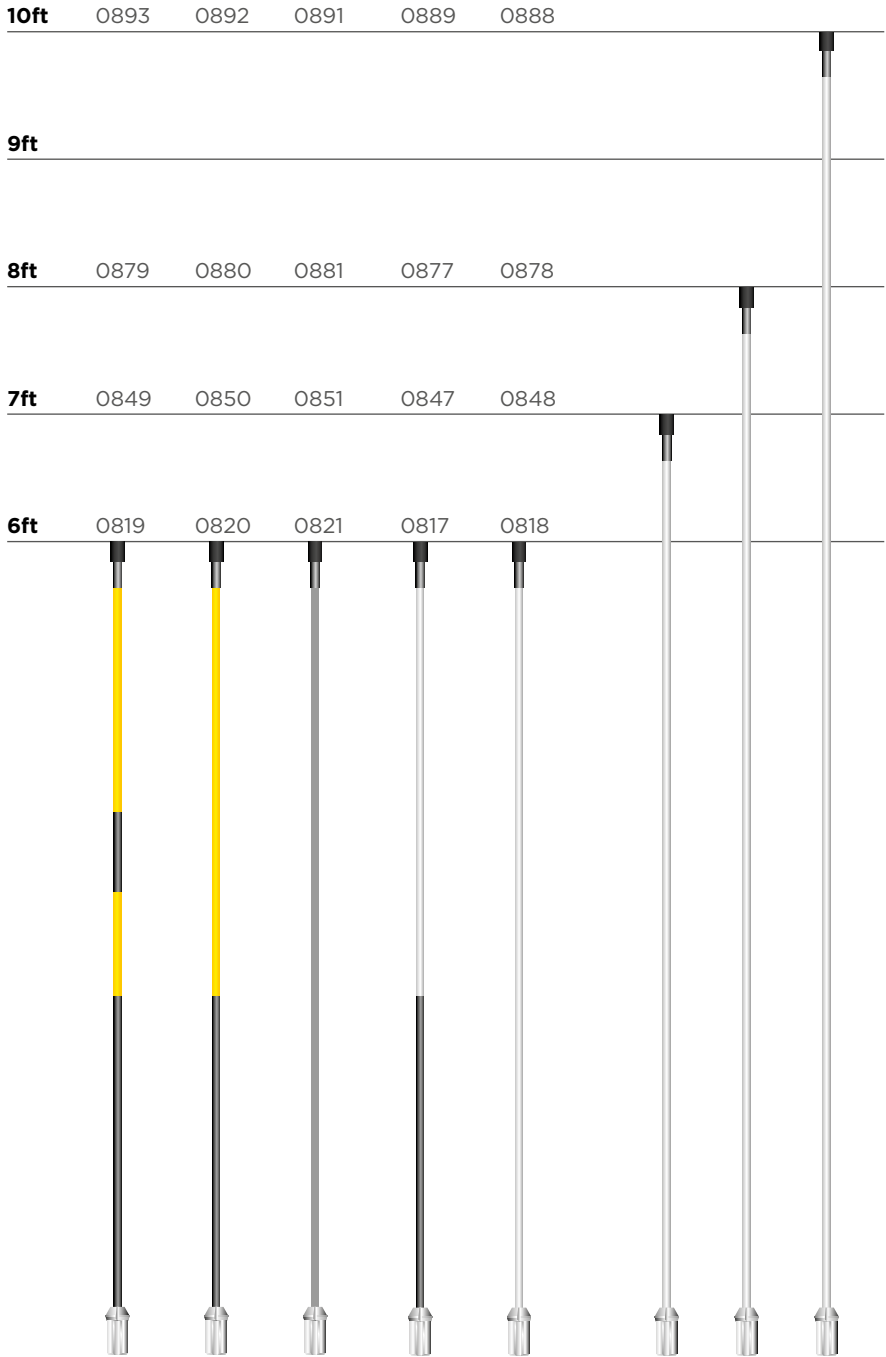

FLAGSTICKS

TACIT TOURNAMENT (JAVELIN) FLAGSTICKS

Improve the visibility of your flagsticks with Tacit's ultra visible Tournament (Javelin) Flagstick. Standing straight and tall at 7ft, 7ft 6in, and 8ft it is tapered from $\frac{3}{4}$ in from the center to $\frac{1}{2}$ in at either end. Made from solid color impregnated composite material and then covered with our highly visible sleeving this is truly the champion of flagsticks.

All Tacit flagsticks come complete with Tacit's unique anti-stick, anti-swivel ferrule which results in reduced sticking, reduced ferrule and holecup wear and consequently upright flagsticks lasting longer than all the rest.

All Tacit's Flagsticks meet USGA and R&A specifications.

The Machrihanish Dunes flagsticks have been developed in conjunction with The Machrihanish Dunes Golf Club in order to produced a stiffer flagstick. Created for the unique conditions that make up the British coastline, it is more wind resistant and highly visible.



MACHRIHANISH DUNES TOURNAMENT (JAVELIN) FLAGSTICKS

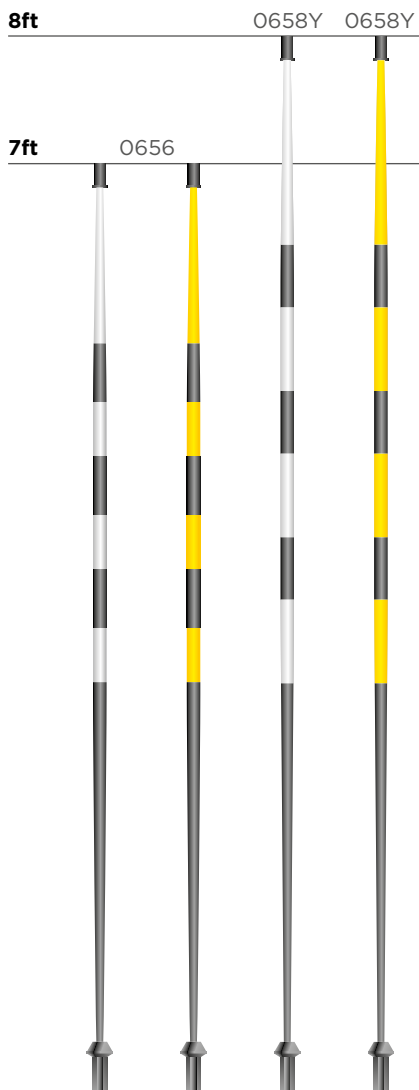

**TACIT TOURNAMENT
(JAVELIN) FLAGSTICKS**

8ft 0668W 0668R 0669 0669Y 0669YBB 0668 0669YBS

7ft 6in 0660 0667 0661 0662 0663 0664 0665

7ft 0671W 0674 0671WBB 0671Y 0674YBB 0671 0671YBS

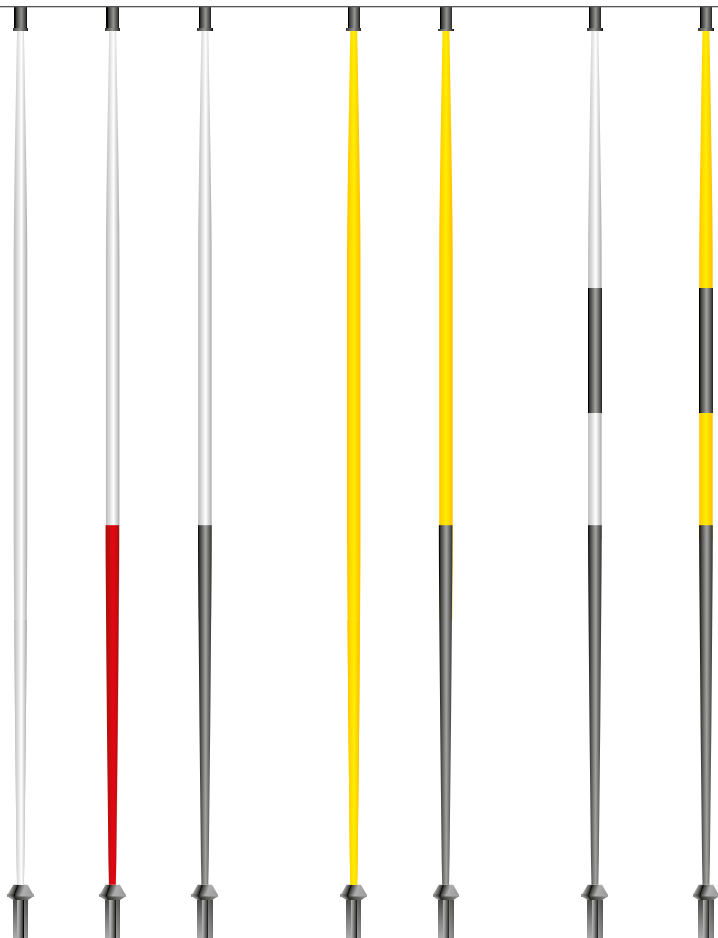

HICKORY

Tacit's Hickory Flagstick has been made to recreate the look and feel of courses at the inception of golf.

Hickory wood is known for its hard wearing and flexible properties, coupling with brass fittings results in a truly individual, stylistic and long lasting addition to any course.

An Iroko Ball Top is also available as an alternative to a flag.

Available at 7ft 6in as standard and also as a matching putting green marker or chipping pin.



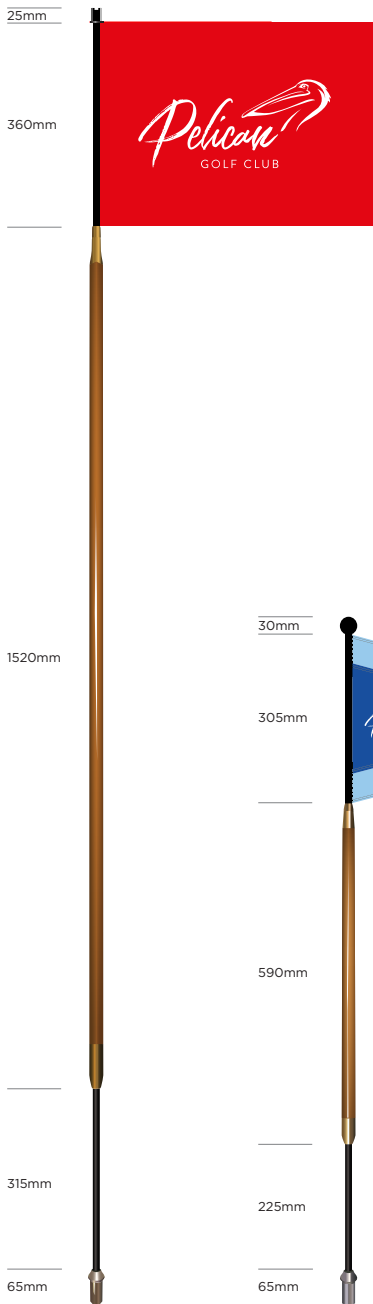

FLAGSTICK
0520

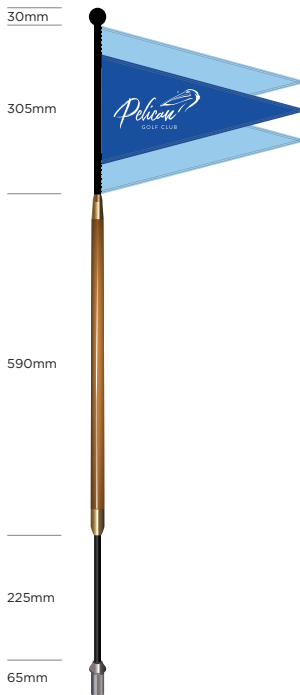

CHIPPING PIN
0521



IROKO BALL TOP
0525

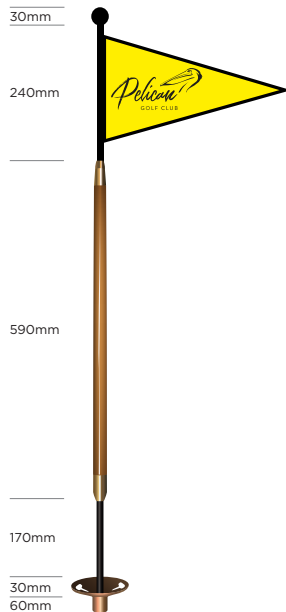

PUTTING GREEN MARKER
0522B

TACIT HOLECUPS



“We have found the Tacit holecups to be long lasting. More importantly they stand up well to windy conditions and help the hole keep its shape.”

Gordon Moir

Former Director of Greenkeeping,
St Andrews Links Trust



THE HOLECUP THAT STOPS...

- ★ Flagsticks blowing out!
- ★ Holecups sinking!
- ★ Ferrules wearing out!
- ★ Flagsticks leaning over!

Our revolutionary design that ends the ever-sinking holecup.

The sub cap positioned beneath the holecup effectively expands the surface area by 300%, preventing it from sinking below the USGA and R&A recommended depth of one inch. Furthermore, this sub cap acts as a barrier, preventing rootzone from entering the holecup and rising through the central ferrule socket, ensuring a precise fit for the flagstick every time.

Tacit's ferrule was designed with anti-rotational splines fitted to the underneath that fit snugly into the holecup. The combination of ferrule and holecup also ensures the flagstick does not lean, twist or rotate which would usually cause excessive wear or blowouts.

Top dressing and debris is shed through the holecup - not in the ferrule bore.

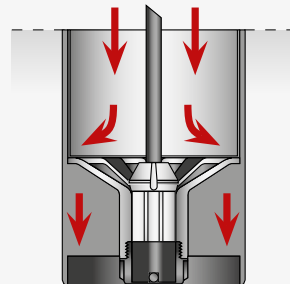

The unique profile prevents rotation, therefore reducing wear and stopping the flagsticks from blowing out.

No ingress of soil, rootzone or other substrate.



HOLECUPS

TACIT HOLECUPS

Tacit's revolutionary holecup design. The unique profile and splines of the ferrule and holecup combined ensure the flagstick does not lean, twist or rotate which would usually cause excessive wear or blowouts.

Fits USA size ferrules. Available in nylon or aluminum to match your choice of ferrule.

USA PUTTING CUP

Fits USA size ferrules and are designed to fit Tacit Putting Markers.

HOLECUP COVER

Protective cover used to safeguard the holecup on the green. Available in ¼in for regular holecups.

HOLECUP INSERTS

Compliment the aluminum holecup with either a plain or printed insert. Inserts can be printed with your own design, club logo, championship logo or corporate sponsor in order to give your course or event a distinctive high quality finish.

HOLE STABILIZING RINGS

A pack of 18 hole stabilizer rings to give your holes a crisp edge and to prevent bounce backs.



USA ALUMINUM HOLECUP
0899PL

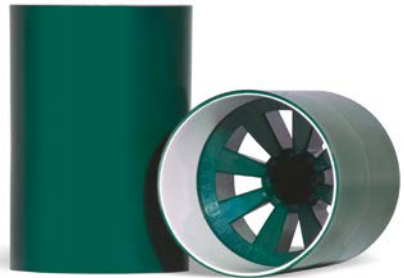

USA GREEN NYLON HOLECUP
0918A



USA PUTTING CUP
0985



4 1/4in HOLECUP COVER
0931



HOLECUP INSERTS WITH LOGO
0899L (Single)

HOLECUP INSERTS
0899S (20 pack)



HOLE STABILIZING RINGS
0907 (18 pack)

PUTTING GREEN

CHIPPING FLAG

Flags can be plain, digitally printed, screen printed or embroidered.

CHIPPING PIN

Standard Tacit chipping pin in white with a black base. Measures 3ft 3in.

CHIPPING FLAG 0983Y



CHIPPING PIN
4501

LOGO FLAG 0979L



PUTTING GREEN PIN
0947SF

PUTTING PIN WITH SPIKE
0947SPIKE



BLACK BALL TOP 0993 (Other colors available)



PIN AND BASE
0947SB

LIFTER BASKET AND FERRULE
0376



FLAG STYLE MARKER

Flags can be plain, numbered or customized. Various colors are available.

PUTTING MARKERS

Back-saving putting marker with lifter basket for less bending. Various colors are available.



PUTTING MARKER

0948ALM

0984ALM

0964ALM

0962ALM

0952AL

**ECONOMY
PUTTING
MARKER**

0953N



**PIN
AND
BASE**
0958

A photograph of a golf club headcover standing upright on a green golf course. The headcover is silver with a black grip. The background shows a blurred landscape of trees and a blue sky with light clouds. A faint, white hexagonal pattern is overlaid on the right side of the image.

TACIT **REJOINDER**

Tacit's unique interlocking tool that allows turf to be repaired quickly and easily.

Effectively replace damaged, diseased, or dead turf on the green and replace with an exact fit from the nursery green, or from an area on the edge that is less likely to be "in play".

The Rejoinder's uniqueness lies in the shape of its sharp cutting head design, which avoids straight lines, considering that grass doesn't grow uniformly straight. This distinctive shape promotes quicker integration of the new sod with the surrounding turf.

Furthermore, the Rejoinder's unique shape not only securely locks in place when used individually but also offers contoured edges for seamless integration, regardless of the area that needs to be covered. This locking mechanism encourages lateral surface growth, making the sod an integral part of the green in a significantly shorter timeframe. This advancement promises to revolutionize turf repair on the green.



Example of the Rejoinder pattern



FINE TURF TOOLS

SPIKER

A specialized agronomy tool, the rotary spiker enhances water and air penetration while promoting root growth. Additionally, it can be employed to ensure deeper germination when overseeding.

SLOTTER

A specialized tool for overseeding fine turf areas, it maintains surface integrity and ensures the correct depth is obtained. The flat-bottomed slot aids rapid seed germination, enhancing moisture absorption and fostering strong root growth, especially ideal for fescue germination.

LAWN LEVELLER (LUTE)

Tacit's Lawn Leveller (Lute) is manufactured specifically for use on fine turf areas. The Lawn Leveller is ideal for spreading and grading a variety of sands and top dressings, providing a super flat surface.

HOLE GROOMER (CLIPPY)

Achieve a flawless and consistent cut, in a fraction of the usual time, with the Tacit Hole Groomer, meticulously crafted to our highest standards.

With the Tacit Hole Groomer, you can effortlessly reinstate the hole to an exact 4¼in between cutting new holes.

Bracket for mower attachment also available.

REJOINER

Tacit's unique interlocking tool that allows turf to be repaired quickly and easily.

REJUVENATOR

Effortlessly restores ball marks, animal tracks and indentations on the green back to the original putting surface level. Requires no tamping and is designed for ergonomic ease of use. Minimal maintenance required, thanks to the stainless steel tines that ensure a flawless finish for your green.

SPIKER
1040



SLOTTER
1039



**LAWN
LEVELLER
(LUTE)**
1015

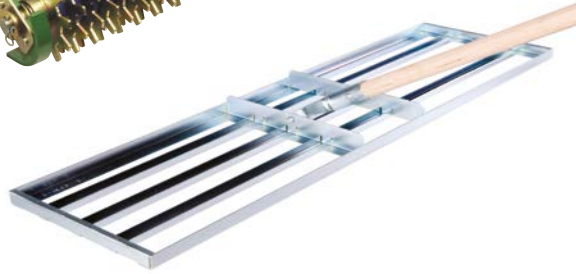

HOLE GROOMER (CLIPPY)
0922

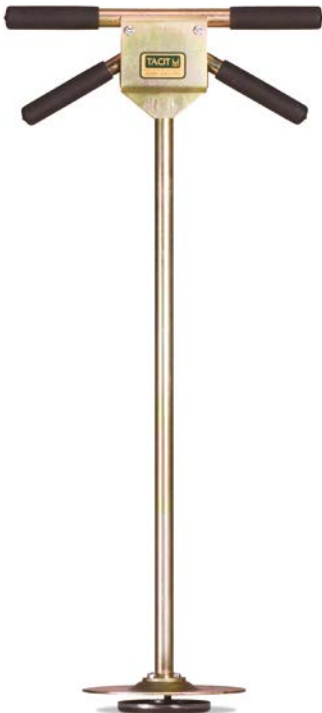

REJOINER
0919J



REJUVENATOR
6040





TACIT RAKES

CARTESIAN RAKE

Tacit's Cartesian Rake was designed and tested with input from greenkeepers across the UK throughout the development process.

The role of a greenkeeper's bunker rake has evolved over time and this rake explores the need for a dual sided rake; the toothed side to fluff the top sand without digging too deep, whilst the flipped side distributes sand around the bunker leaving it perfectly levelled.

The Cartesian Rake also allows for versatility as greenkeepers use rakes for more than just bunkers; pushing and pulling soil for ground repairs, as an alternative for a squeegee to remove excess water on greens and many more on course uses.

Over 100 greenkeepers tested and provided feedback on various shapes, sizes, weights, and styles to reach the final design.

Flat Face



When flipped, the long flat face is perfect for pushing sand and distributing it around the bunker. This ensures there is sand up at the bunker faces and the levels are correct.

Round Back



Once the sand is spread out, the rounded back, used in a pulling motion, glides over the bunker. This helps to prevent high and low patches, smoothing out the sand.

Tapered Teeth



A common flaw in bunker rakes is the end couple of teeth digging deeper into the sand than the middle teeth. The teeth are evenly tapered to prevent this, making each pass of the rake seamless.

Filletted Edges

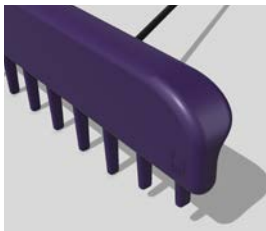

Sharp edges on bunker rakes cut into the sand leaving unsightly furrows. Having filletted edges eliminates these cut marks and keeps the bunker tidy whether using the teeth or back side to the rake.

Rounded Ends



The rounded edges on the back allow greenkeepers to use this rake in any bunker. Tight and unique shaped corners can still be worked on with ease, without disrupting the smooth levelled look.

Short Teeth



The teeth are designed to create a perfect playing surface for golfers, whether you full rake or just rake the bases. The shorter length tooth design prevents the teeth coming into contact with the bunker lining underneath.



RAKES

BUNKER STONE RAKE

A finer mesh allows the stainless steel to remove objects from the bunker larger than ¼in diameter, collecting them for easy removal into a bin. The unique teeth on the underside of the rake break the surface and allow debris to be easily collected from the bunker.

MAINTENANCE RAKE

Makes short work of even the largest bunkers. Long teeth break up the sand, while the short teeth collect any surface debris. Ideal for moving large amounts of sand towards the front of the bunker and on the face.

Also ideal for clearing and collecting organic debris.

WOODEN HAY RAKE

Crafted for discerning golfers, our wooden hay rake combines a robust frame with sturdy teeth, making it both visually striking and ergonomically designed for essential course maintenance.

16P SHORT TOOTH RAKE

Modified specifically for bunker maintenance; the short teeth will not penetrate bunker linings nor will they go deeper than the PGA tournament recommended depth of 1in.

16P LONG TOOTH RAKE

Modified specifically for bunker maintenance; the longer teeth are designed for deeper bunkers where the short-toothed rake is not suitable.

STANDEASY SPARROW RAKE

Undoubtedly, the finest players' bunker rake on the market. Combining Tacit's Sparrow Rake with a stand helps keep the handle dry.

Available in white, green or black.

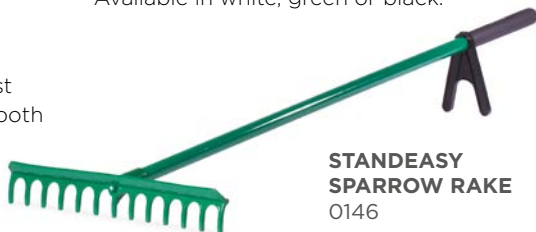

STANDEASY SPARROW RAKE
0146



BUNKER STONE RAKE
0167



MAINTENANCE RAKE
0157



WOODEN HAY RAKE
6007



16P SHORT TOOTH RAKE
6001SS



16P LONG TOOTH RAKE
6001SL



TACIT DEW BRUSH



Tacit's Dew Brush is an essential tool designed to efficiently clear dew from greens while protecting the turf.

KEY FEATURES

- ★ **Efficient dew removal:** Effective at quickly and thoroughly clearing dew from the grass, ensuring consistent playing conditions.
- ★ **Comfortable grip:** Ergonomically handle for ease of use, especially during early morning rounds.
- ★ **Gentle on grass:** Bristles are gentle on the turf, preventing any damage to the greens or fairways.
- ★ **Lightweight:** Easy to carry and maneuver on the course.
- ★ **Weather-resistant:** Designed to withstand exposure to various weather conditions, including moisture and UV rays.
- ★ **Durable construction:** Built to last through multiple seasons of use on the golf course.
- ★ **Easy to clean:** Bristles are easy to clean and maintain for optimal performance.



WATER REMOVAL

ROLLER SQUEEGEE

Lightweight and robust, Tacit's Roller Squeegee is the ideal tool for removing excess water from greens without damaging the sward. A soft core allows for compression of the roller whilst the extra tough skin gives it protection and durability. Head measures 24in.

DEW BRUSH

Tacit produce two Dew Brushes for the discerning greenkeeper. The black version has soft bristles (98in head) that glide easily over the green, clearing dew with a squeegee action. Whilst the Green version, with hard bristles (79in head), flicks the dew into larger droplets, forcing them to be absorbed by the soil.

Both are light, easy to carry and use Tacit's Switch as their handle.

LOW PRESSURE SWITCH

Tacit's Low Pressure Switch has become the industry's recognized standard. Its stiffer switch tip, along with its unique pull-and-lock fixing mechanism, effectively removes dew from greens faster and more thoroughly than any other switch available. The anodized aluminum shaft ensures resistance to rust, while the soft grip offers a comfortable hold even in the cold.

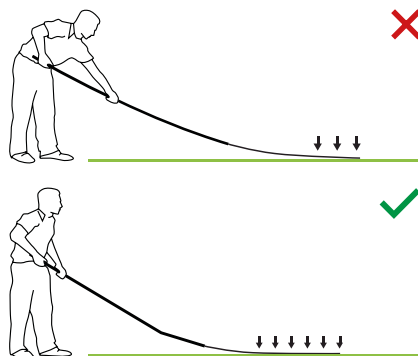

Take the hard work out of switching with Tacit's unique Low Pressure Switch.

LOW PRESSURE SWITCH

1027





ROLLER SQUEEGEE
1011



DEW BRUSH (SOFT)
1033



DEW BRUSH (HARD)
1035

SWITCH TIP
1031

BEVERAGE HOLDER

Using the Tacit Hickory Flagstick, create a unique holder for your putting green with customizable components to suit your club or resort. Engraving option available.



HOLDER COMPONENTS



Cigar Holder



Wine Glass Holder



Cup and Alignment Holder
with Club Rest



Cup Holder



TOP OPTIONS



Etched Zinc
Ball Top



Aluminum
Shaped Metal



Engraved Wood with
Painted Finish

BASE OPTIONS



Aluminum
Ferrule



8" Base Plate &
Stainless Steel Spikes



Stainless Steel Spike
with Bronze Foot Plate

GENTLEMAN'S CLUB REST

Enhance the appeal of your driving range with the Gentleman's Club Rest from Eagle - a sleek solution that holds up to five clubs, features a built-in cup or cigar holder, providing golfers with unmatched convenience and organization during their practice sessions. Personalised engraving available.



Available in Contrast Core or hardwood



KEY FEATURES

- ★ **Portable & Lightweight:** Easy to carry around the club and store.
- ★ **Versatile Choices:** Available in Contrast Core or hardwood.
- ★ **Stable Base:** Designed to remain stable on various surfaces.
- ★ **Compact Size:** Efficiently designed to occupy minimal space.



Par West

17952 Lyons Circle
Huntington Beach, CA 92647

Email - sales@parwest.com

Phone - 714-893-1555

www.parwest.com



www.tacitgolf.com