

**Model Pro-M Workstation  
INSTALLATION GUIDE  
and  
OWNER'S MANUAL**

# CONGRATULATIONS!

You have just purchased the number one turf equipment service lift available worldwide. We are sure you will be pleased with its unsurpassed ease of use and versatility. In fact, other Trion owners like you frequently express that Trion has surpassed their expectations. We trust you will be similarly pleased.

As you prepare to set up and use your new workstation, it is essential that you review the information in this manual carefully. Following the assembly instructions shown here will make the process smooth and complete in the shortest amount of time, and a quick review of the rest of this manual will help you take advantage of Trion's many valuable features and ensure complete safety for you and the machinery you will be servicing.

If you ever have any questions, expert assistance is never more than a phone call away. We are delighted to be able to serve you. Please call us during normal office hours Monday-Friday (Mountain Time) using our toll-free number:

**800-426-3634**

## SERIAL NUMBER

The serial # of your Pro-M workstation is stamped onto a plate that is mounted to the upper inside corner of the non-control leg of the lift. Record this number below for future reference.

Serial # \_\_\_\_\_

## TABLE OF CONTENTS

Choosing the location for your Pro-M Workstation .....	3
Overview of the Assembly Process .....	4
An Overview of Terminology .....	4
Installation Tools List .....	5
The Contents of the Shipping Package .....	5
Step-by-Step Installation	
Drilling Holes for Anchor Bolts .....	6
Unpack and Lay Out Components .....	6
Attaching Legs to the Top Beam .....	7
Assembly and Adjustment of Controls .....	7-9
Hooking Up Cables .....	10
Installing Accessories .....	10-11
Raising the Lift to Upright Position .....	11
Attaching Tool Bars and Final Components .....	12-13
Final Adjustments .....	13-16
Using the E-Kit (Optional) .....	17
Safety and Instructional Decals .....	18
Safety Instructions .....	19
Specifications	
Construction .....	20
Oil .....	20
Motor/Pump/Wiring .....	20
Operating Instructions .....	21
Tips for Using Your Trion Workstation	
Positioning Equipment on the Lift .....	21
Positioning the Wheel Forks .....	22
Moving the Wheel Tray .....	23
Using the Tool Bar Extensions .....	23
Cost-Saving Preventative Maintenance .....	23
Maintaining Your Trion Workstation	
Power Unit Maintenance .....	24
Cable Maintenance .....	24
Cleaning Check Valve and Seat .....	24
Wiring Schematic .....	25
Trouble Shooting Guide .....	26
Operator Certification Checklist .....	27
Warranty .....	28



# CHOOSING THE RIGHT LOCATION

Since your Pro-M Workstation will be in constant use once it is installed, the location should be carefully selected. We recommend that a service bay be designated with ready access to tools, parts, electrical and air supply.

The operator controls of your workstation may be installed on either side of the lift (with the motor end of the top beam always positioned above the control leg),

but the wheel tray should always be placed at the rear of the lift. A clear area roughly 20 feet wide and 16 feet deep (20' deep, if Tool Bar Extensions are added) will provide sufficient room for the lift, as well as walk and work space at the sides and behind it.

Your lift should be located near an access door, so vehicles can easily be brought in for service. In the sample layout below, a right angle

placement has been selected in relation to the access door. This is a suitable option when the lift will be dedicated to turf equipment service. If you plan to raise road vehicles, you will need more drive-in room and a much straighter access lane.

Feel free to call Trion's Customer Service if you have specific questions about your shop's layout.

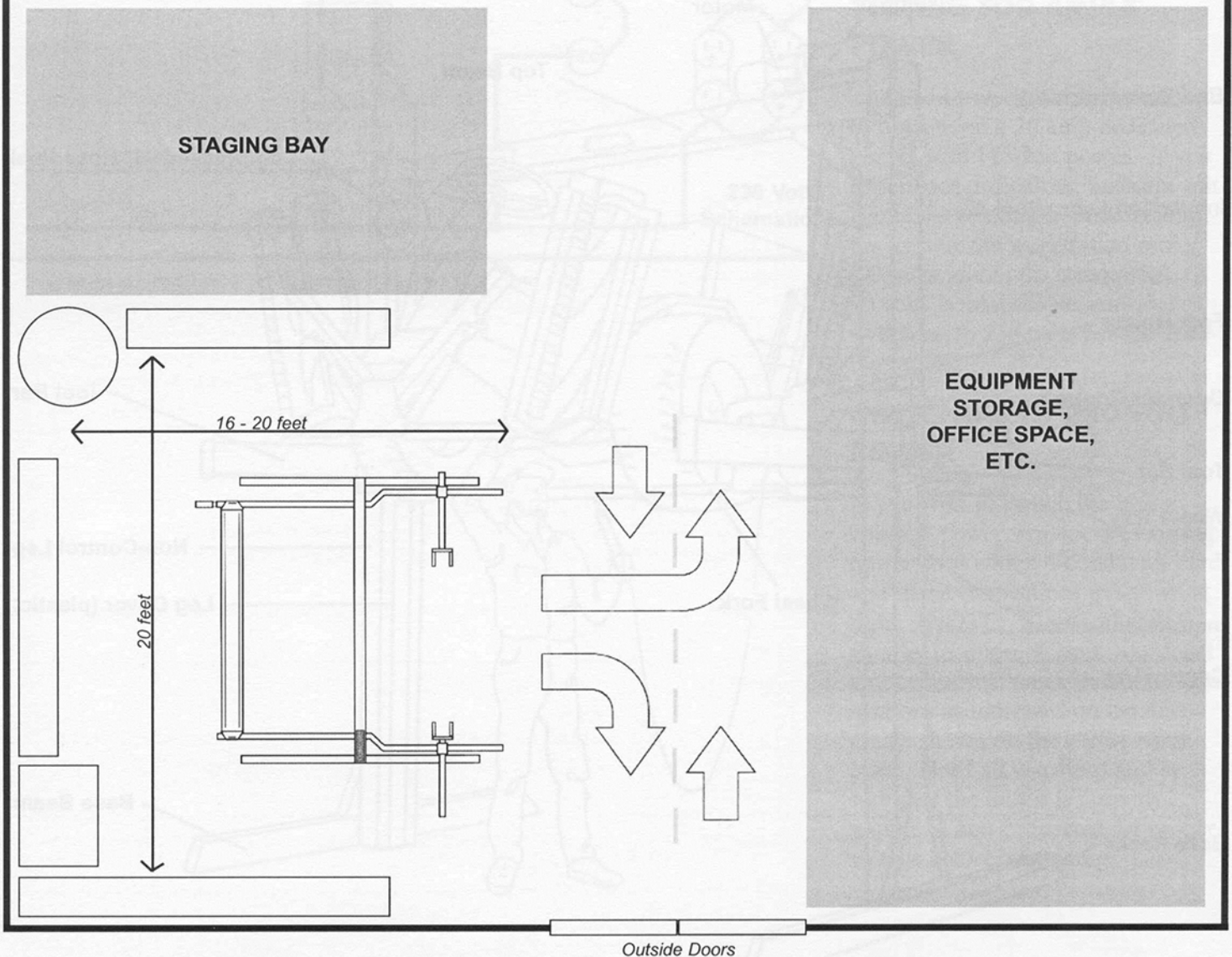



# THE ASSEMBLY PROCESS

At right is an overview of the installation process you are about to begin. Efficient installation can be assured by completing each segment of the process before proceeding to the next.

If you are unfamiliar with the components of your Trion workstation, you may refer to the illustration below to familiarize yourself with the basic parts and the terminology that will be used throughout this manual.

	<u>Description</u>	<u>Step(s)</u>	<u>Page(s)</u>
I	Drilling Holes for Anchor Bolts	1	6
II	Unpack and Lay Out Components	2	6
III	Attach Legs to the Top Beam	3-4	7
IV	Assemble and Adjust the Controls	5-11	7-9
V	Hook up Cables	12-14	10
VI	Install Accessories	15-16	10-11
VII	Stand Up Lift	17-19	11
VIII	Add Tool Bars and Other Components	20-23	12-13
IX	Final Adjustments	24-33	13-16
X	(Optional) Using the E-Kit		17

## An Overview of Components and Terms Used In This Manual

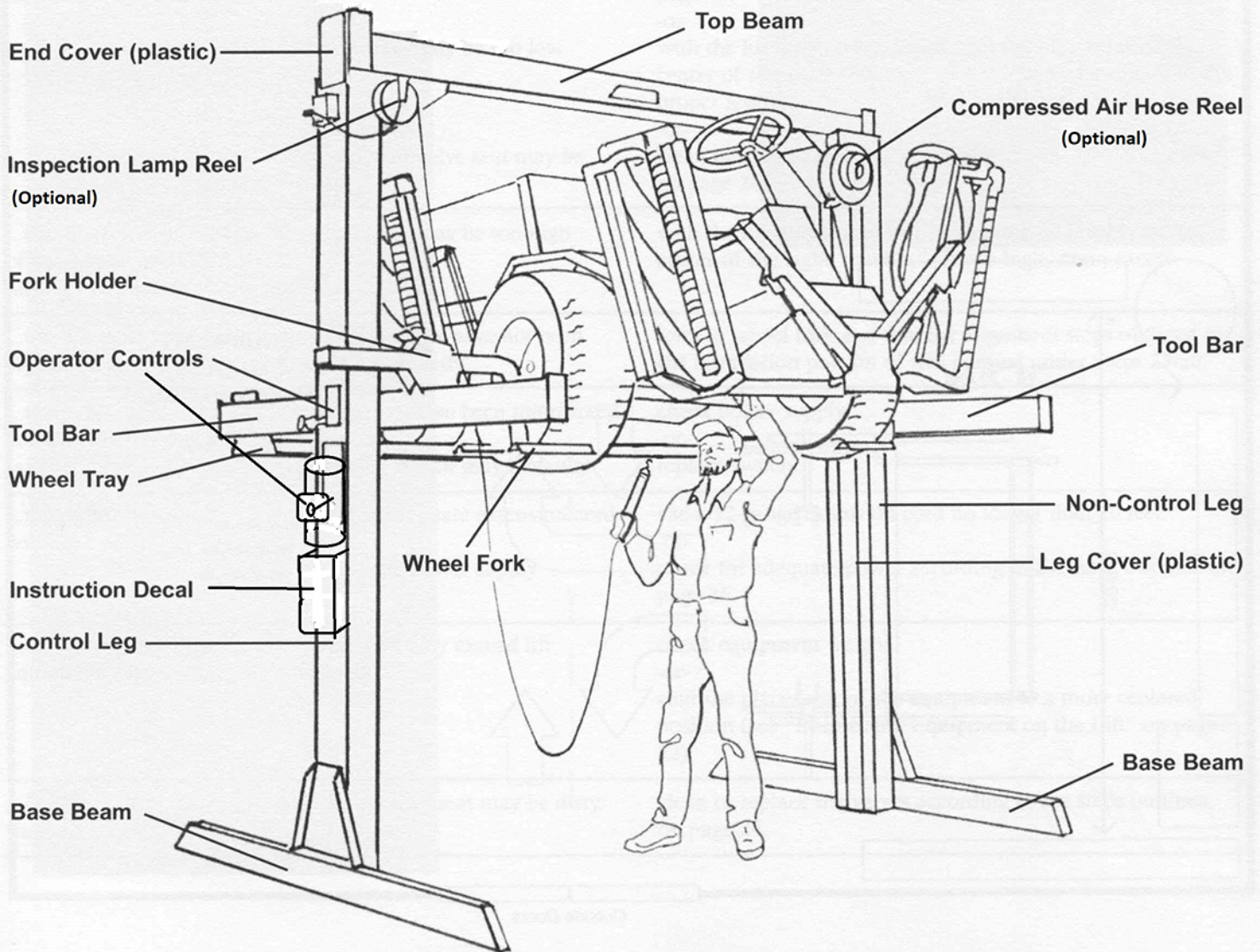



## INSTALLATION TOOLS

Once you've decided on a suitable location for installation, make sure you have the following tools at hand:

- 1 Hammer Drill  
with 1/2" masonry bit
- 2 Qts. All-Season Hydraulic Fluid
- 1 1/2" Ratchet Wrench  
with 10"-12" extension
- 1 Wire Cutter
- 1 15/16" Socket
- 1 3/4" Socket
- 1 1-1/8" Socket
- 1 7/8" Deep Socket
- 1 End-combo Wrench, 3/4"
- 1 End-combo Wrench, 9/16"
- 1 End-combo Wrench, 1/2"
- 1 End-combo Wrench, 7/16"
- 1 Pry Bar, flat x drift
- 1 Hammer
- 1 Vice Grip
- 1 Needle-nose Pliers
- 1 Phillips Screwdriver

You will also need approximately three hours of assembly time and the brief use of a forklift or bucket loader when it is time to raise the top beam to an upright position (Step 17). If a forklift or bucket loader is not available, you may call Trion and request the use of our E-Kit. This come-along system is available for use at no charge to you as long as it is returned intact after assembly is complete.

## YOUR SHIPPING PACKAGE

Upon opening your workstation package you will find the following items:

**Retain all fasteners that were used in packaging, they will be used in installation**

- 2 Base Beams
- 2 Legs with Slide Beams installed
- 1 Top Beam  
Power Unit, Hydraulic  
Cylinder and Cables installed
- 1 Wheel Tray
- 2 Tool Bars (either Standard or  
Extra-wide version)
- 2 Tool Bar Extensions  
(optional, if selected)
- 2 Fork Holders
- 2 Wheel Forks
- 2 Safety Control Rods
- and-
- 1 Parts Box, containing:  
1 bag of Hardware

If your order included a DL1300 Mobile Lift Table, it will be packaged separate from the workstation. If your order included any optional accessories, these are typically shipped via UPS and will arrive separately. If your accessories do not arrive within 3-4 days after your workstation delivery, you may call Trion to check on the status of this shipment.



**1** Begin by measuring for the location of four anchor bolts to fix the workstation in position on the floor. Although Trion workstations are self-supporting and free-standing, it will be important to secure the workstation's position to prevent eventual misalignments that can occur during use.

Measure carefully according to the diagram at right and, using a 1/2" masonry bit in your hammer drill, make four holes in the floor that are 2-1/2" deep. Insert the anchor bolts (provided) in these holes and secure by hammering the expansion pin until it is flush with the end of the anchor bolt.

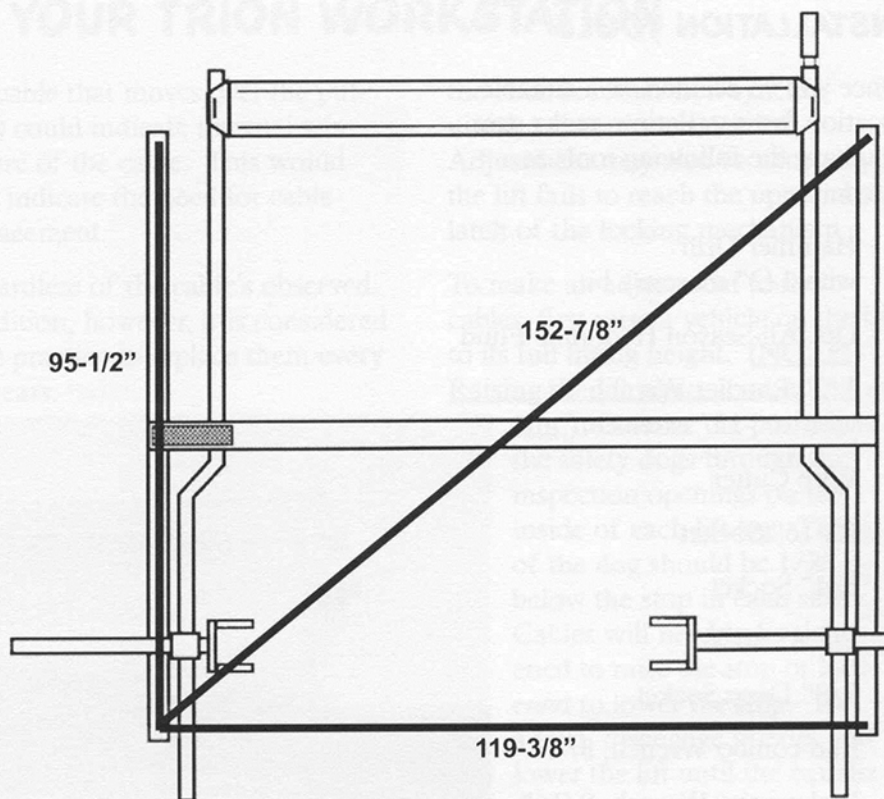

**2** Lay out the major lift components from the shipping package into the service bay area as shown below. Determine which side you would like to operate the lift from and position the **Control Leg** (with the operating instructions decal) on that side. Also place the **Top Beam** across a pair of sawhorses (as shown in the center photo, opposite page), or a fork lift or the box of a utility vehicle so that the end with the **Power Unit** is on the same side as the **Control Leg**. **IMPORTANT: Save all nuts and bolts from the shipping package, as they will be used in the assembly process.**

Miscellaneous items from the shipping package such as **Accessory Reels, End Covers, Toe Guard, Leg Covers** or **Tool Bar Extensions** may be set aside until required in the assembly process.

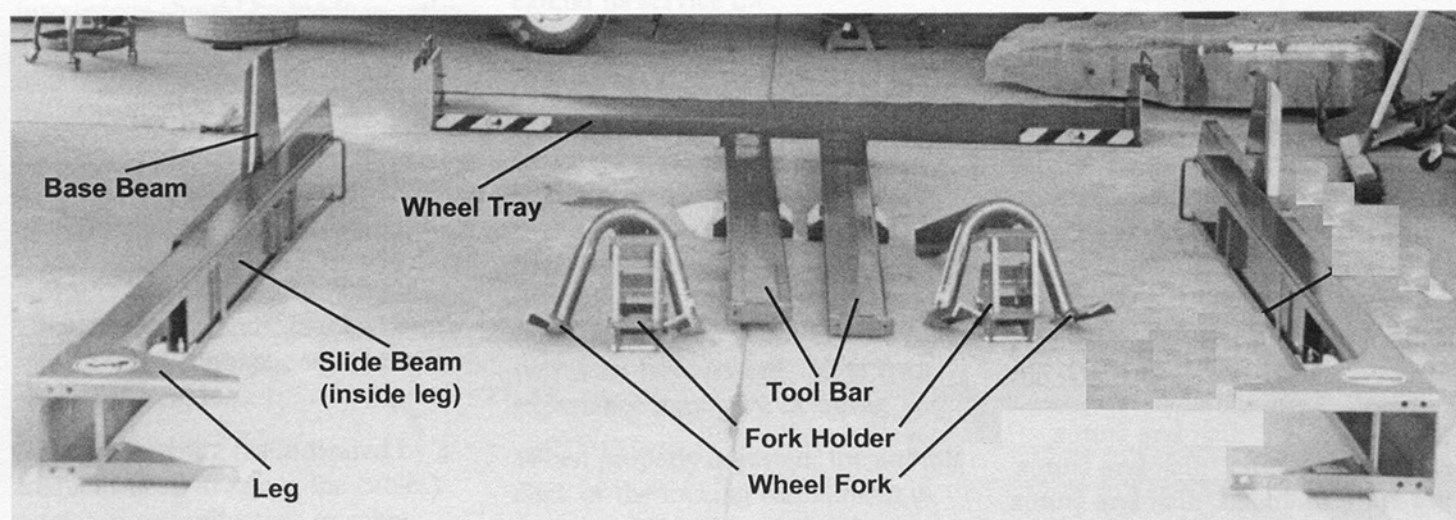

Not Shown: Top Beam



**3** Place **Base Beams** over the anchor bolts with the flat side placed inward. If a crown in the floor prevents the **Base Beam** from resting firmly, shim as needed with 1/2" flat washers (not included) as shown in photo at right.

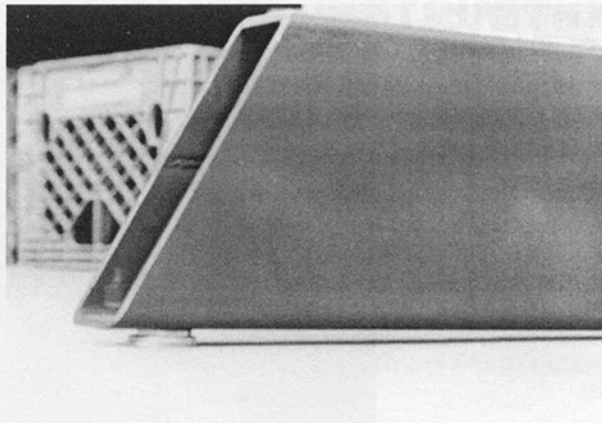

Install a flat washer and nut on the anchor bolt, but **DO NOT TIGHTEN**. Leave approximately 3/8" clearance between the nut and washer. Nuts will be tightened after erection is complete.

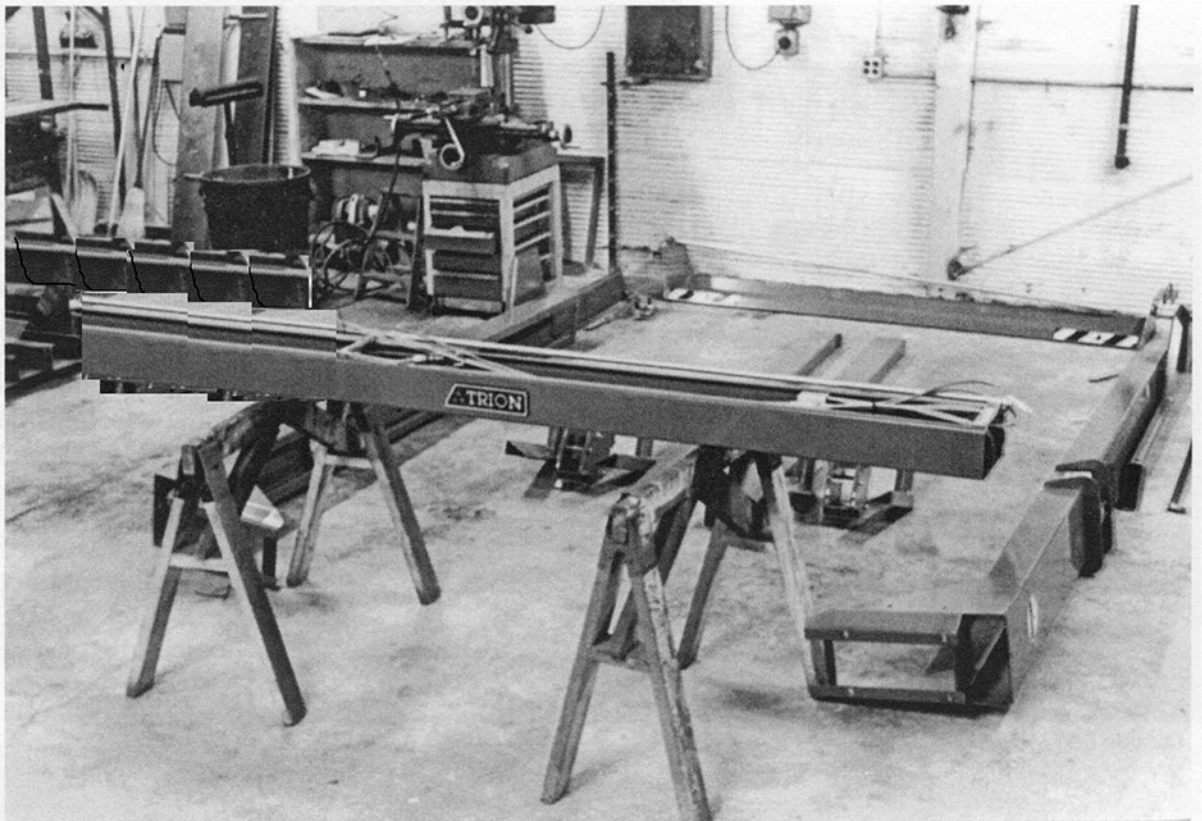

**4** Lay the **Top Beam** on its side across the supports you've provided. Sawhorses are shown above as supports. A fork lift or the box of a utility vehicle could be used as an alternative.

Raise the gusset end of one **Leg** to meet the bottom of the **Top Beam** and loosely install four 1/2" bolts and lock washers from the leg hardware parts bag. Repeat this process for the other **Leg**; then tighten all bolts.

**5** Using the wire cutters, cut the ties that secure the **Cables** and electrical cords in the packaging. One of the cords is the power cord and the other is the pump control pendant which will extend down the inside of the **Control Leg**.

**Page Intentionally Left Blank**



**8** Install the first safety control rod (the one with the pin end) on the **Control Leg** side by inserting the pin end of the rod through the hole in the safety lever on the **Top Beam** as shown at right.

Then place the hole of the flattened end over the pin in the safety control. Install a flat washer and secure the assembly with a cotter pin.

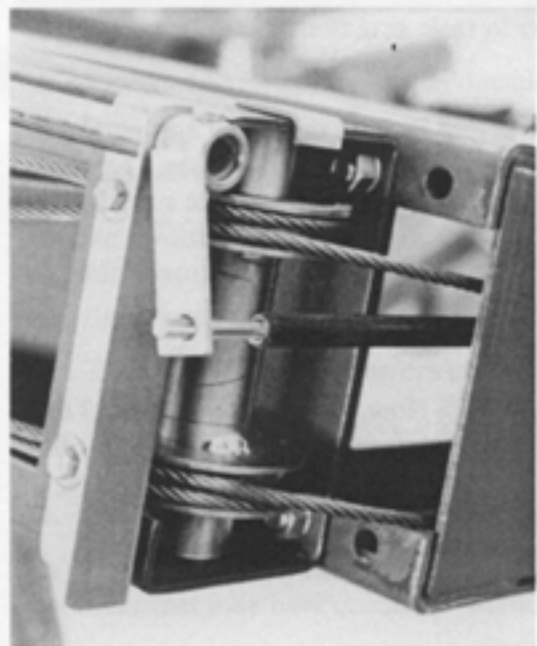

**9** Install the second safety control rod (the one with the threaded end) on the **Non-Control Leg** by inserting the threaded end of the rod through the hole in the safety lever on the **Top Beam** as shown at left.

Place the hole of the flattened end over the pin in the safety latch. Install a flat washer and secure the assembly with a cotter pin.

**10** Cut the wires that hold the **Slide Beams** at the bottom of each **Leg**, and raise the **Slide Beams** until the safeties are engaged.

Then push down each **Slide Beam** to ensure that the safety is securely locked.

**NOTE:** It may be necessary to manually engage the safety.



**11** Install the 5/16" nyloc nut on the threaded end of the safety control rod in the **Non-Control Leg** as shown at left. With the safety lever on the **Control Leg** side resting on top of the rod, tighten until all play in the safety mechanism is removed.

#6 HOSE 5000# W/ 1#6 DRF  
& 1#8 DRF FITTING 47" OIL

INSTALL FILTER HERE

Remove all old plumbing  
& motor/ tank setup

SAE #8 DRB / DRF 90° FITTING

SAE #6 DRB / DRF 90° FITTING

SAE #6 DRF / DRF 90° FITTING

#6 HOSE 5000# W/ 2#6 DRF  
FITTINGS 79" OIL



The best way to drain the old cyl is to place some kind of hose over the discharge (open end) of the cyl. & manually stroke it a few times to clear the oil from that end. Perhaps part of the old (removed) plumbing could be put in service for this. If after the new pump / tank unit is installed and put in service oil doesn't stop coming out of open end of the cylinder the ran piston seal is bad. The filter is then installed to keep dust out & protect the ran seal.  
Dick Gaston



**12** Cut the ties that secure the cables to the **Top Beam** and feed them into the **Legs**, allowing the cables to pass through the open side of each **Leg** and hang loose.

Push the **Slide Beam** up to the top of the **Non-Control Leg** first. Install cables in the equalizers as shown at right.

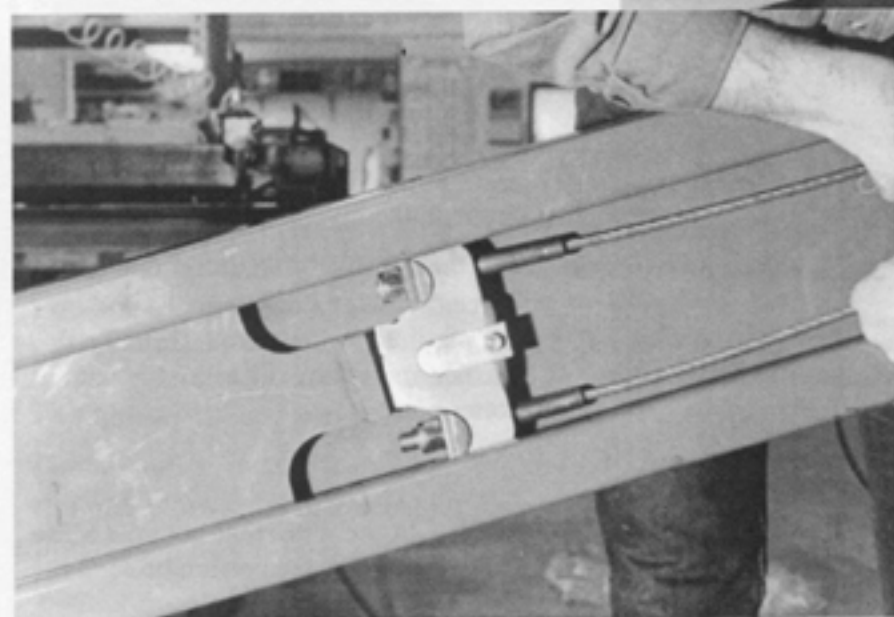

**13** Release the safety and push the **Slide Beam** down the **Leg** until the cables are tight. Make sure the cables are in the pulley grooves and are not crossed or wrapped around the control/safety rods.

**14** Now, repeat steps 12 and 13 to attach the cables for the **Control Leg** side.

**15** If your purchase included optional electrical and compressed air reels which are to be mounted to the workstation, install these and the **End Covers** now.

The Power Extension Cord and Inspection Light reels attach to each side of the upper portion of the **Control Leg** using the bolts provided. One of these bolts also holds the **End Cover** in place (shown at right) at each end of the **Top Beam**. Plug electrical accessories into the outlets provided on the **Power Unit**.

**NOTE:** To avoid any possible damage to the accessories, do not lengthen the cord clips until after the lift has been raised to an upright position.

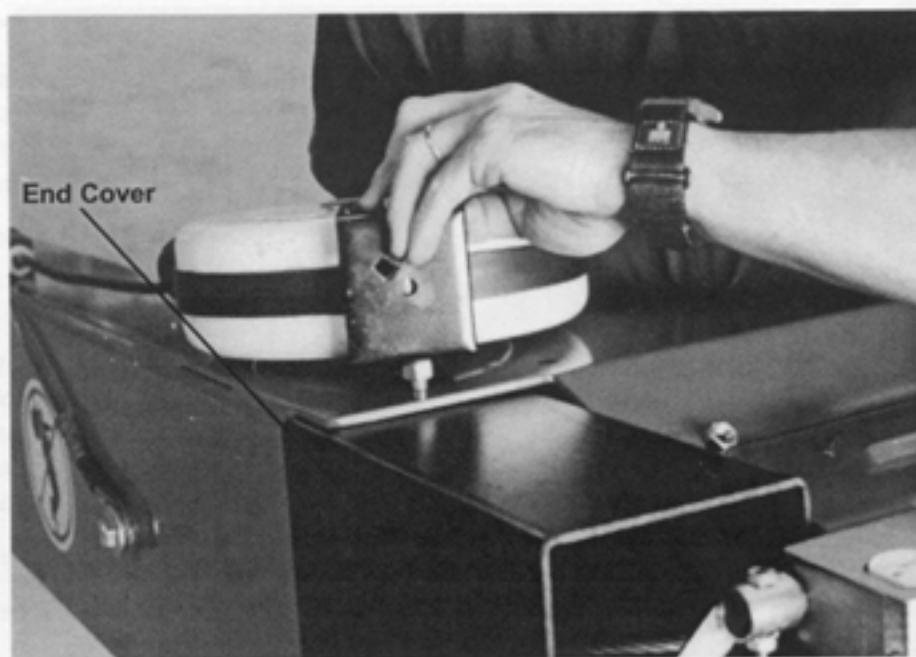

**16** Mount the air hose reel to the **Non-Control Leg** as shown at left, using the bolts and lock washers provided. (NOTE: Two of the required bolts have been used in the air hose packaging and should be used in the upper mounting holes.)

After the lift is fully assembled, you can adjust the clip and extend the air supply from its source to the connector on the hose reel.

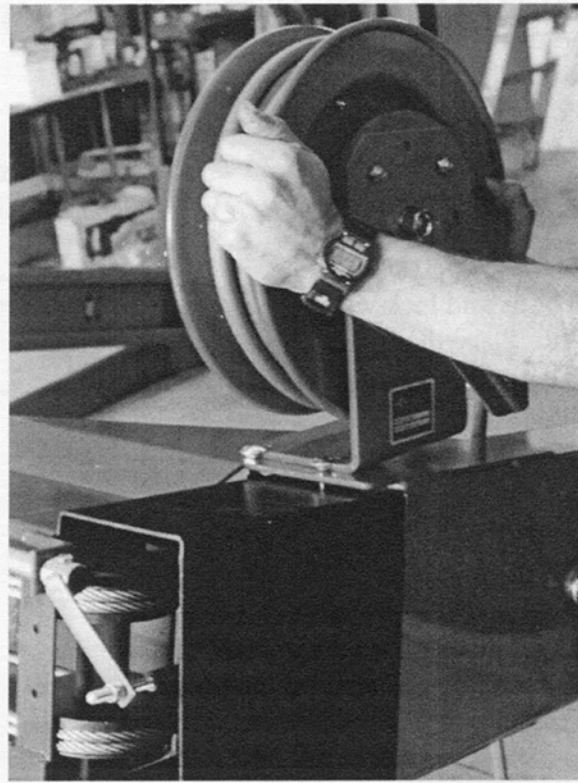

**17** Lift the bottom end of each **Leg** and install one 1/2" x 1" bolt into the **Leg** hole and **Base Beam** hole as shown in the sketch at right.

(NOTE: If you are using Trion's E-Kit to raise the **Top Beam**, please refer to page 17 for instructions to perform this step.)

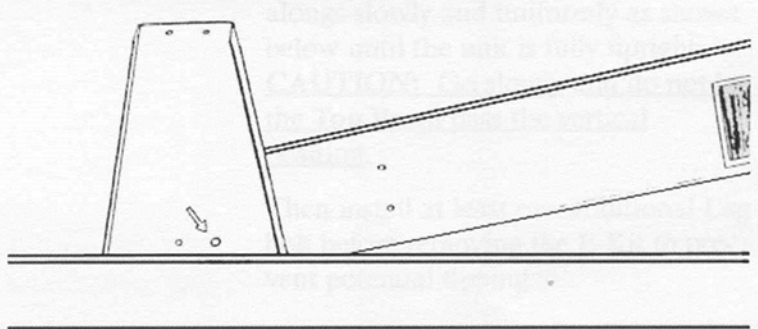

**18** Using a fork lift as shown in the photo below or with a bucket loader, raise the **Top Beam** to an upright position. **CAUTION: Go slowly and do not let the Top Beam pass the vertical position.**

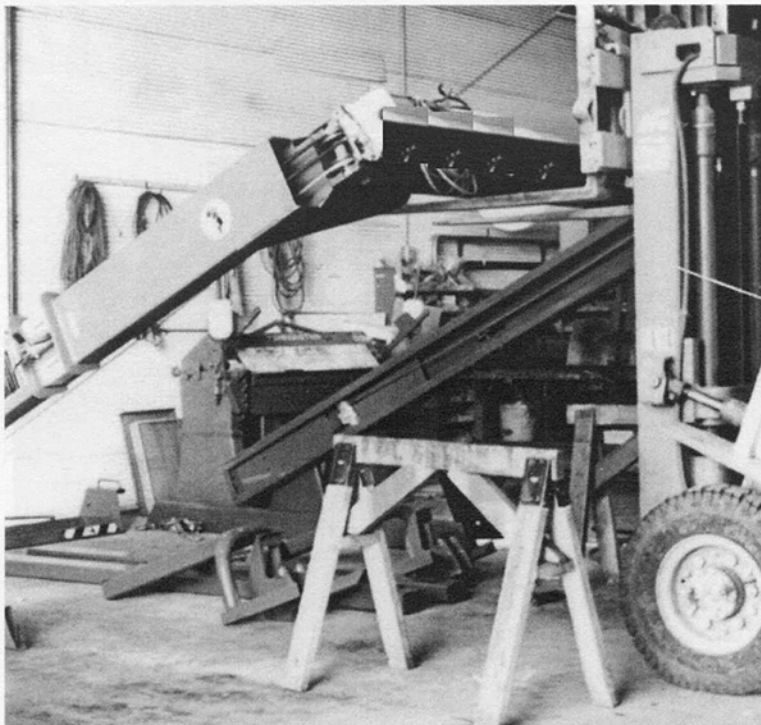

**19** Complete bolting of the **Legs** to the **Base Beams** using 1/2" x 1" bolts, lock washers and cone nuts. Install lock washers on bolts, inserting from the outside and securing with a cone nut facing the **Leg**. Then tighten the **Base Beam** anchor bolts to the floor (the ones you left loose in Step 3).

**Connect Power as per local code**



**20** Raise the unit off the safety stops and then lower it until it is approximately three feet (3') off the floor. (You may need the assistance of another person or two who can add their weight to pull the slides down.)

Fasten the **Tool Bars** loosely to the slide beams with the two 5/8" and one 3/4" mounting bolts and lock washers as shown at right. Place the **Wheel Tray** end of each **Tool Bar** (the end with the positioning slots along the outside edge) toward the back of the lift. **NOTE: Do not tighten the mounting bolts yet.**

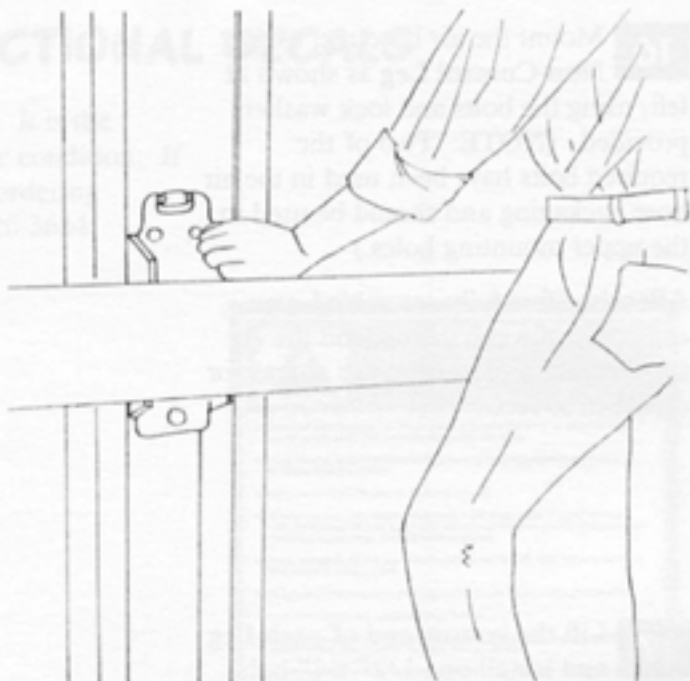

**21** Place the **Wheel Tray** on the **Tool Bar** with the black/yellow safety striping at the back, and so the **Wheel Tray** is secured in the positioning guides on each side.

**22** Hook the **Fork Holders** to the forward ends of the **Tool Bars**.

Remove the 3/8" bolt and nyloc nut on each **Fork Holder**. Then insert the **Wheel Forks** into the **Fork Holders**. Replace the bolt and nut as shown in the photo at right. Tighten the bolt just enough to still allow the **Wheel Fork** to slide easily through the **Fork Holder**.

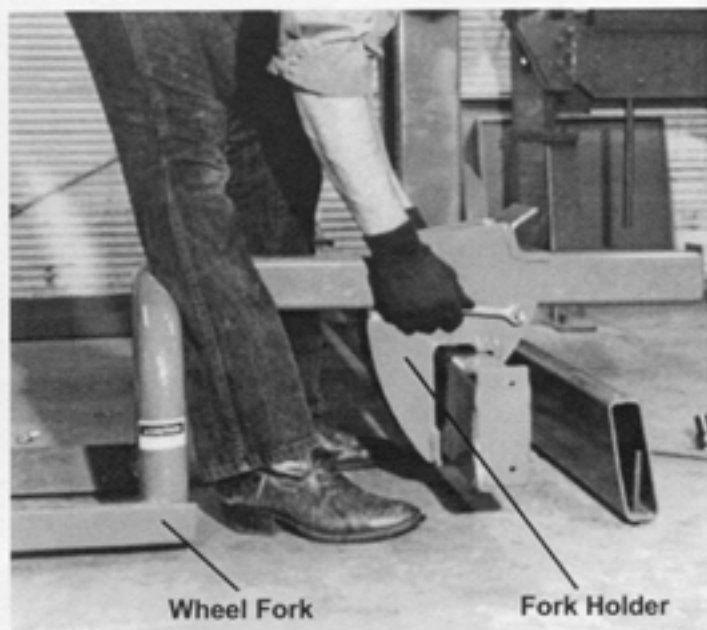

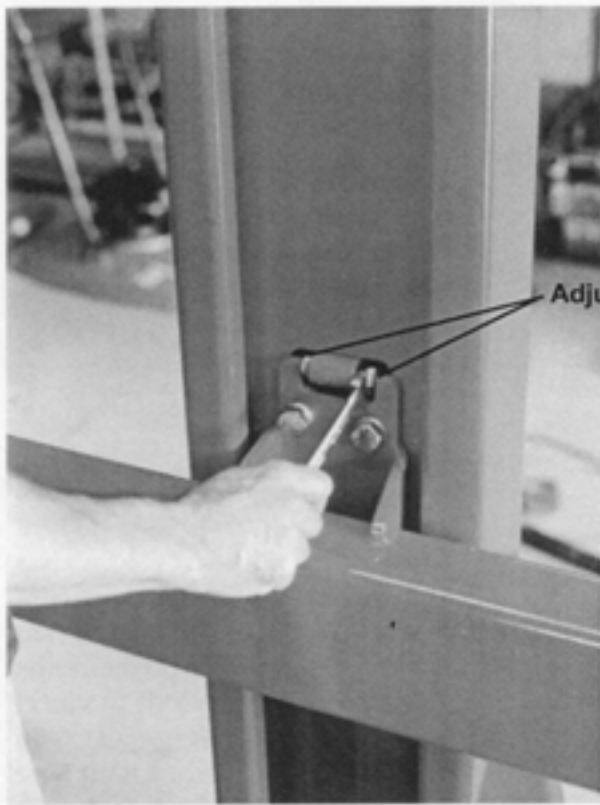

Adjustment Screws

**23** Install the end cap (provided in the controls and covers parts bag) on the operator control handle.

**24** The oil reservoir was filled with fluid in order to test the **Top Beam** assembly and the Power Unit prior to packaging. Cycle the lift up and down twice. With the lift raised to its highest position, observe the fluid level, which should measure to the center of the sight glass. Add ISO32 Hydraulic fluid (see suggested brands on page 24) only if the fluid level is low.

**25** It is not necessary for the **Legs** of your workstation to be plumb, but the **Tool Bars** must be fixed parallel to the floor at the appropriate level for easy loading and unloading of your equipment. The steps below will adjust these alignments to your floor.

#### TOOL BAR ALIGNMENT

Tighten the bottom **Tool Bar** mounting bolt and lower the **Tool Bar** to the floor. Then position the **Wheel Fork** at the extreme front end of the **Tool Bar** and, with the fork pushed to its widest position, either tighten or loosen the opposing adjustment screws (indicated in the photo above) in order to raise or lower the **Wheel Fork** until it rests parallel to the floor. The illustration at right shows how the **Wheel Fork** might rest before alignment and how it should rest afterward.

BEFORE ALIGNMENT

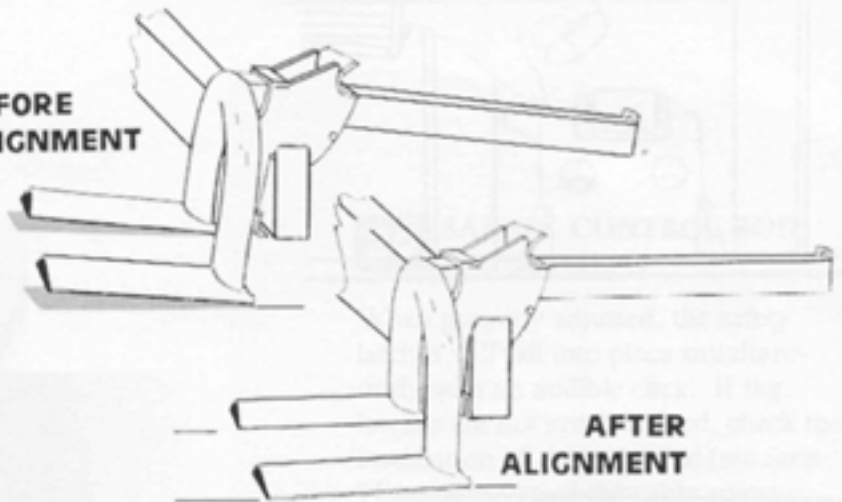

AFTER ALIGNMENT



## 26 WHEEL FORK ALIGNMENT

Tighten all three tool bar mounting bolts and observe whether the **Wheel Fork** rests on the floor.

If the **Wheel Fork** does not meet the floor, as shown in the photo at right, loosen the mounting bolts and insert a shim (provided) between the **Tool Bar** mounting plate and the **Slide Beam**, as shown below. Retighten the mounting bolts and check the **Wheel Fork** again. Shim again and re-adjust more, if necessary.

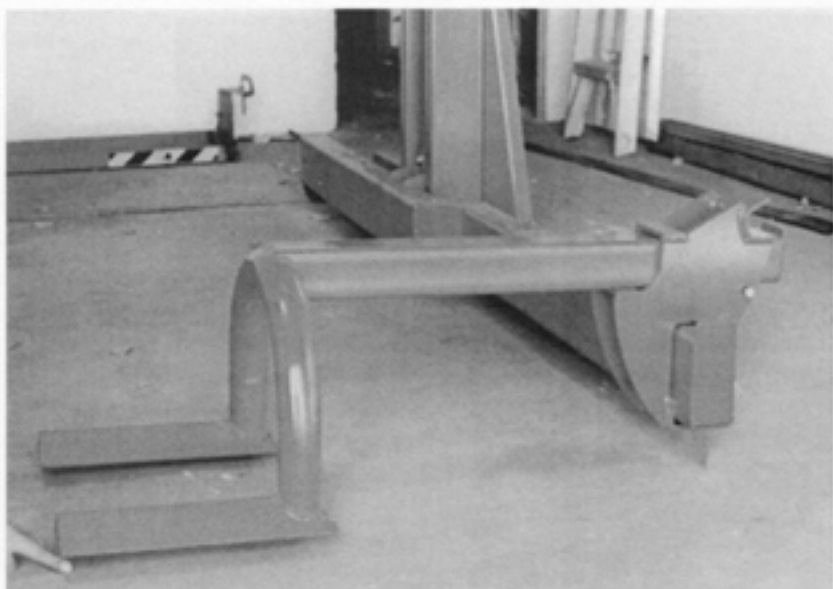

27 Repeat Steps 25 & 26 to adjust the **Tool Bar** on the opposite side of the lift.

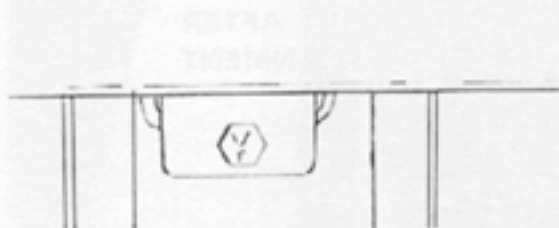
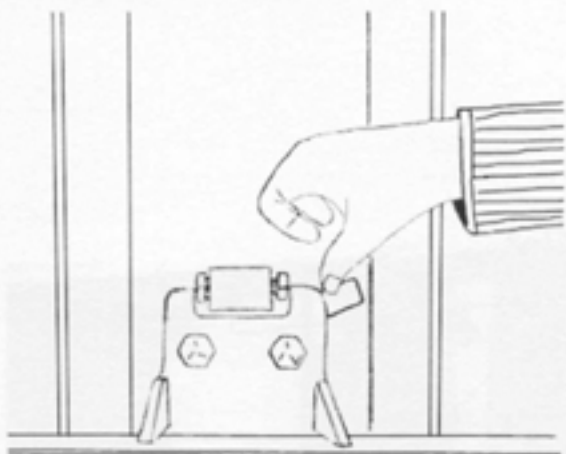

28 Locate the hole approximately two feet (2') from the bottom of the slide beam.

28 If your workstation is equipped with (optional) **Tool Bar Extensions**, slide the narrow end of each into the open end of the **Tool Bar**. First loosen the locator bolt (indicated below); then retighten after the extension is inserted.

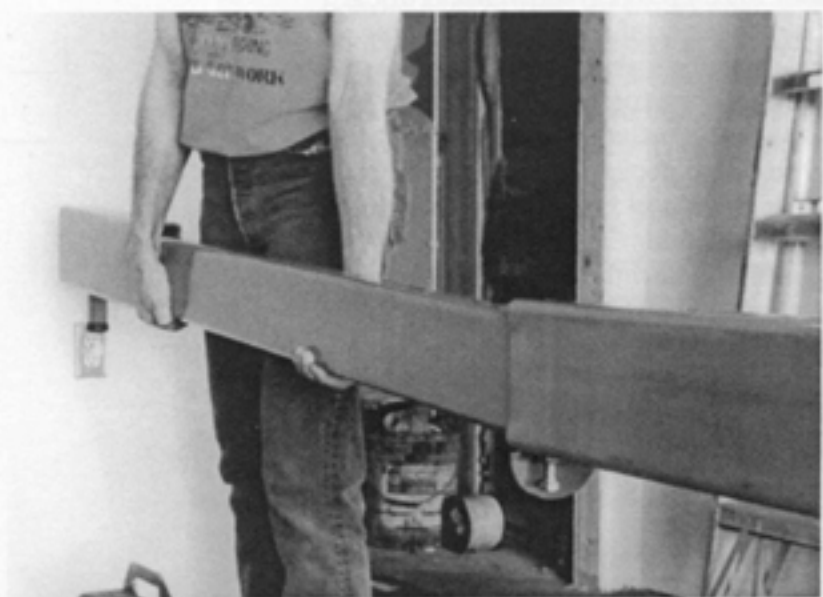

**29** Raise the lift to its full height while observing the position of the safety dogs through the inspection openings on each side. (**IMPORTANT:** This procedure must be performed with a vehicle on the lift.) The tip of the dog should be aligned with the mark 1/2" below the stop on each side, as indicated in the diagram at right.

If repositioning is necessary, the cables should be tightened to raise the stop or loosened to lower the stop. To adjust the cables, disengage the safeties and lower the lift until the equalizer is at a convenient height; then rest it on the safeties. Tighten or loosen the cable nuts as required as shown below. After adjusting, raise the lift again to its full height to check the position of the dogs. Repeat the adjustment, if necessary, until both dogs are 1/2" below the safety stop.

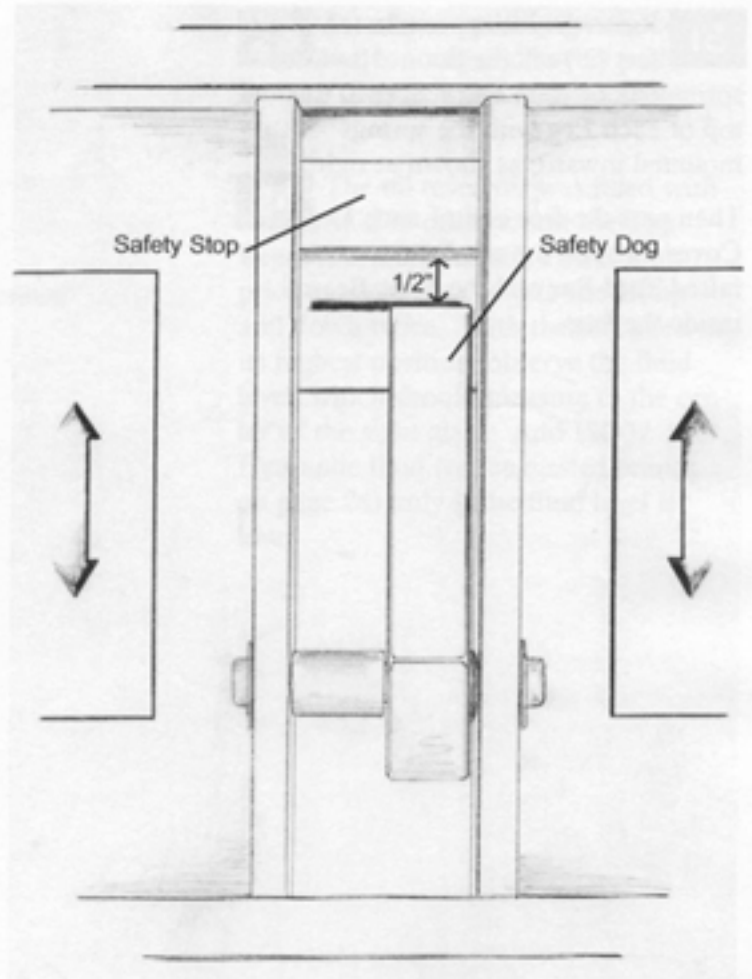

BEFORE  
ALIGNMENT

### **30** SAFETY CONTROL ROD ADJUSTMENT

When properly adjusted, the safety latches will fall into place simultaneously with an audible click. If the latches are not synchronized, check the installation of the nyloc nut (see Step 11 on page 9) and the cable adjustments described in Step 29 above.

**NOTE:** At this point, unload equipment from the lift before proceeding to Step 31.



**31** Raise the lift approximately two feet (2') off the floor. Hook the spring end of each **Leg Cover** to the top of each **Leg** with the springs mounted inward, as shown at right.

Then pass the free end of each **Leg Cover** through the gap between the raised **Tool Bar** and the **Slide Beam** inside the **Leg**.

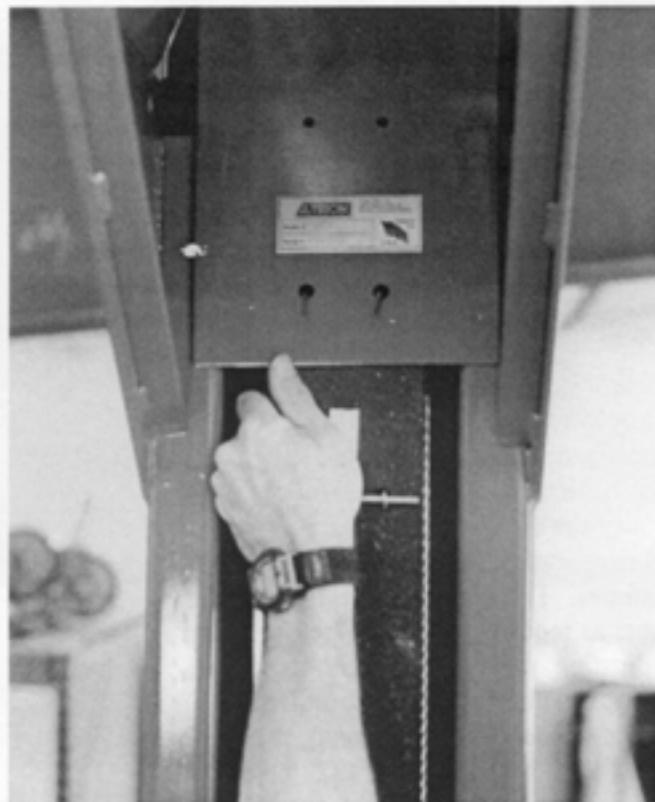

**32** Locate the hole approximately two feet (2') from the bottom end of the **Leg Cover**. Adjust the lift height until the bottom of the **Slide Beam** is even with this hole. Insert the tab of the **Leg Cover Installation Tool** (provided) into the hole in the **Leg Cover** as shown in the photo at left.

Slowly lower the lift until the **Tool Bar** contacts the top of the **Leg Cover Installation Tool**. Continue lowering to stretch the springs. This will tighten the **Leg Cover** until the holes at the bottom edge of the **Leg Cover** align with the holes in the bracket at the bottom of the **Leg**. secure the **Leg Cover** with two 5/16" self-threading screws. Then raise the lift slightly to remove the **Leg Cover Installation Tool**.

**33** Repeat Step 32 to fasten the **Leg Cover** for the opposite **Leg**.

### **CONGRATULATIONS!**

**Installation is complete. Your Trion workstation is now ready for operation.**

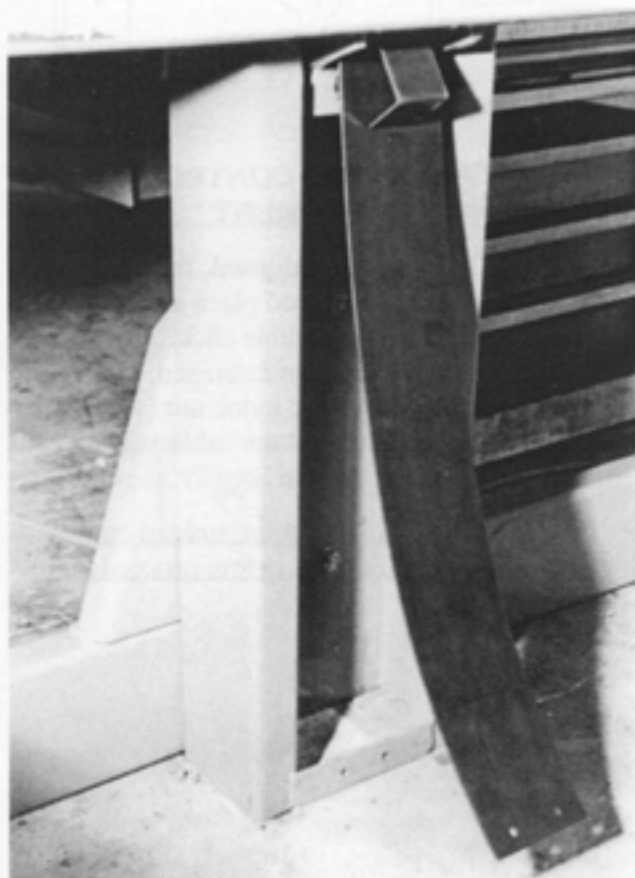

## Using the E-Kit (Optional)

Lift the bottom end of each **Leg** and install one 1/2"x2" bolt through the hole in the **Base Beam**, **Leg** and the **Erection Tube** as shown in the sketch at right.

Bolt the cables to the holes provided at the top of the **Legs** as shown below, using the 3/8" bolt, nut, washer and spacer provided.

Then hook the come-alongs to the end of each **Base Beam** as illustrated in the sketch at right and take up the slack.

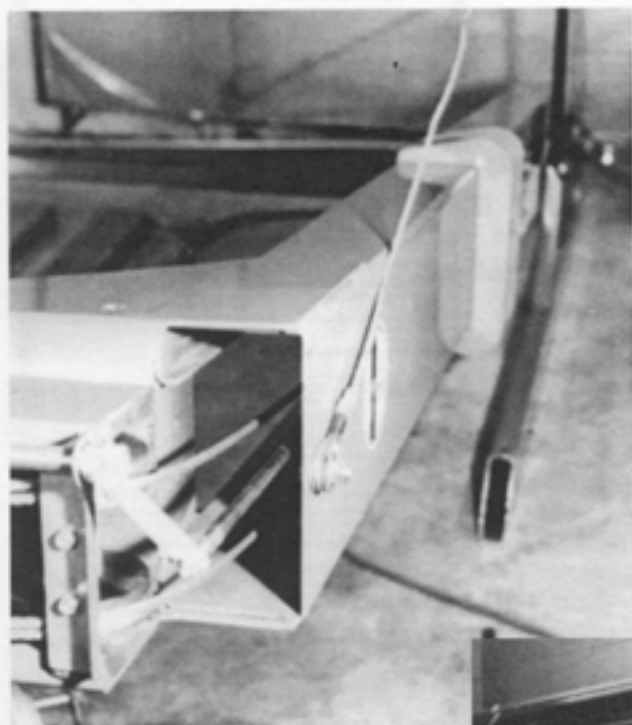
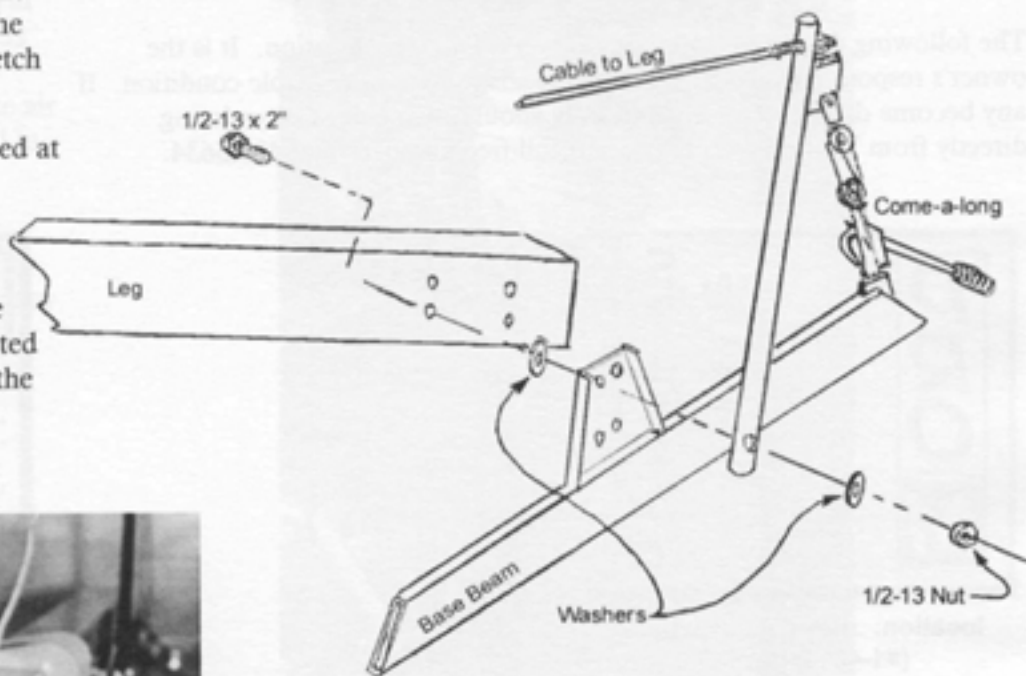

Raise the **Top Beam** with both come-alongs slowly and uniformly as shown below until the unit is fully upright. **CAUTION: Go slowly and do not let the Top Beam pass the vertical position.**

Then install at least one additional **Leg** bolt before removing the E-Kit to prevent potential tipping.

Once installation is complete, repack the E-Kit in the box it came in and call Trion at 800-426-3634. They will arrange for UPS to pick up the E-Kit at their expense and will also provide the return labels needed.

Once the E-Kit has been returned, your deposit will be reimbursed.

**Return now to Step 19 on page 11 to complete the assembly process.**





# SAFETY AND INSTRUCTIONAL DECALS

The following decals are installed on every Trion workstation. It is the owner's responsibility to be sure that decals remain in readable condition. If any become damaged or illegible, they should be replaced by ordering directly from Trion Lifts, Inc. via our toll-free number: 800-426-3634.

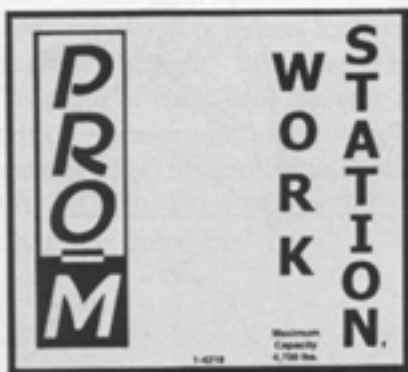

location: non-control leg  
(#1-4218) pair

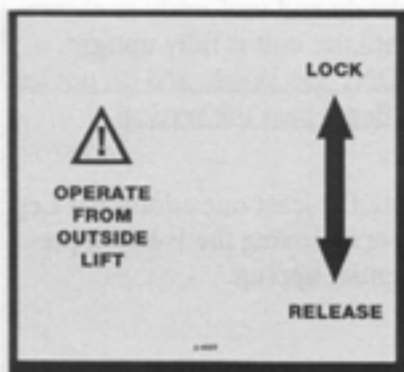

location: control leg  
(#2-4022)



location: wheel fork  
(#1-2531) pair



location: control leg  
(#2-2551)

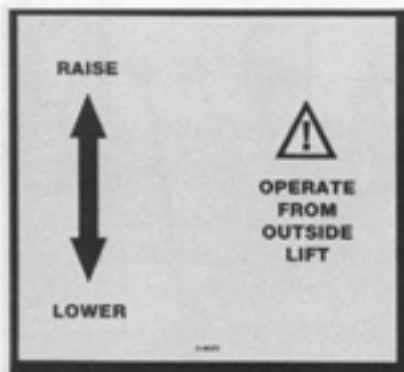

location: control leg  
(#2-4023)



location: top beam  
(#2-2542)



location: top beam  
(#2-2543)

# SAFETY INSTRUCTIONS

1. Always use common sense while operating this workstation.
2. Never attempt to operate your Pro-M workstation if it appears to be malfunctioning or if broken or damaged parts are evident.
3. Never allow persons who have not been thoroughly acquainted with these cautions and operating instructions to operate or be in the lift area during its operation.
4. Never overload the specified capacity of your Pro-M workstation.
5. Never attempt to lift only one end of a vehicle with your Trion. Such action could cause lift damage or the vehicle to fall.
6. Take care when driving vehicles onto your workstation so as not to damage any part of either.
7. Keep the workstation area clear of obstructions, debris, grease and oil.
8. Always operate controls from outside the lift area to avoid lowering equipment on yourself.
9. Keep all body parts clear from under the workstation during operation.
10. Do not use the overhead beam of your Trion as a support for lifting with a chain hoist or other suspended device.
11. Remove all occupants of the vehicle to be raised and keep all bystanders clear while operating.
12. The controls and locking devices are designed for your safety. Never attempt to disable or override them.
13. Always fully engage wheels in the wheel forks and wheel tray. Failure to do so will allow the raised equipment to become unstable and fall.
14. Do not use the wheel forks on tires smaller than specified. Flat tires may also fall through the forks.
15. Perform periodic maintenance inspections (see detailed information on page 24) to detect damage or excessive wear that may have occurred. Remove any damaged product from service immediately.
16. Be sure to use the tool bar extensions, if so equipped, only at their full length. Raising heavy equipment while they are only partially extended may result in damage to these components.

**Be sure you read and fully understand all the operating instructions and cautions before attempting to use this workstation.**



**This safety alert symbol draws special attention to warnings or dangers relating to personal safety. Be sure to read and understand the instructions it indicates. Failure to comply may result in personal injury.**



# SPECIFICATIONS

PRO-M WORKSTATION	(Basic Model)	(with Extra-Wide Tool Bars)	(with Tool Bar Extensions)
<b>Dimensions</b>			
Overall Height .....	138" (351 cm.)	--	--
Overall Length .....	121" (301 cm.)	--	154" (391 cm.)
Overall Width .....	122" (310 cm.)	--	--
Shipping Weight .....	1,685 lbs. (630 kg.)	add 30 lbs. (11 kg.)	add 95 lbs. (35 kg.)
<b>Capacities</b>			
Maximum Weight Load .....	4,700 lbs. (1,755 kg.)	--	--
Maximum Equipment Wheel Width			
Wheel Forks .....	.82" (208 cm.) OA	96" (244 cm.) OA	--
Wheel Tray .....	.96" (244 cm.) OA	96" (244 cm.) OA	--
Minimum Equipment Wheel Width			
Wheel Forks .....	.42" (107 cm.)	49" (124 cm.)	--
Wheel Forks w/small wheel adapters .....	.31" (79 cm.)	38" (96.5 cm.)	--
Maximum Equipment Wheel Base .....	.86" (218 cm.)	--	140" (356 cm.)
Minimum Equipment Wheel Base .....	.20" (51 cm.)	--	--
Lifting Height / Lifting Time* .....	.72" / 58 seconds	--	--
<b>Features</b>			
Power Unit	1-1/2 HP 220 volt/60hz 20 AMP		--
Controls	All in one location		
Installation	Easy self installation using common tools -- approximately 2-1/2 hours		
Warranty	Limited 5 year parts warranty and 30 day satisfaction guarantee		
*Note: The overall height and lifting height may be modified if customized height reduction is selected.			

## Construction

Every Trion lift is manufactured of quality steel to specifications that provide a minimum of 3:1 safety ratios at all stress points, weld, etc. They are wired and plumbed at the factory with pre-assembly and testing performed on every lift prior to packaging.

## Oil

Your Pro-M workstation was filled with Mobile DTE 13M (ISO32) hydraulic oil prior to packaging so the pump and motor could be tested. You may refer to the maintenance

instructions on page 24 for details on oil fill servicing and suggestions for alternate compatible oil brands.

## Motor

The Pro-M is equipped with a 1-1/2 HP motor that may be wired to a 20 amp dedicated circuit.

## Pump

The hydraulic unit of your Pro-M

workstation has a fully enclosed pump that was pre-tested for pressure leaks and drift prior to packaging for shipment.

## Wiring

Standard wiring for all Trion workstations shipped to U.S. 220 volt

# OPERATING AND SAFETY INSTRUCTIONS

1. Consider the optimum position for your vehicle before driving it into place. Most equipment can be raised on the Trion workstation without making adjustments to the wheel tray, but you may wish to move the wheel tray forward or back along the tool bar to allow a roll bar or canopy to clear the top beam.

2. With the lift in the fully lowered position and the wheel forks at their outermost extension, load the vehicle by carefully backing between the tool bars onto the rear wheel tray. **NOTE:** Unless your Pro-M is equipped with Extra-wide Tool Bars, you may find that a couple of exceptionally wide items need to be driven into the lift in a forward position so the wheel tray accommodates the widest wheel track.

3. Slide the wheel forks around the remaining wheels, making sure to fully engage the tires. **NOTE:** Very wide vehicles will require pre-positioning of the wheel forks before backing the equipment into place. Once this is done, it is helpful to note the positioning requirements and mark your equipment with the positioning guide decals we've provided. See details on page 22.

4. Raise the equipment by pressing the green button on the control panel. You will hear the safety latch mechanism click at every 3" as the lift raises.

5. When the vehicle has been lifted approximately 6 inches off the floor, stop and shake the vehicle moderately to evaluate stability. Use caution! Unstable vehicles will fall! Only after this test should you continue raising the vehicle to a comfortable working height.

6. After lifting the vehicle to a desired working height, lower the unit until it rests on the first available safety lock.



**Never service a vehicle on your lift unless the safety locks have been engaged.**

7. During servicing, if any heavy component is to be removed or added to the vehicle, be careful not to create an unbalanced condition. Unbalanced vehicles may fall.

8. When service is complete, be sure to clear area around and under the lift before lowering. Warn bystanders to stand clear.

9. Lower the lift by first raising it off the safety locks until the lock release lever can be fully depressed. Then hold the release lever while pressing the red button on the control panel until the vehicle is completely lowered.

10. When the vehicle has been fully lowered to the floor, move the wheel forks to their outermost extension before driving the vehicle out of the lift area. (Again, when the wheel forks have been pre-positioned for very wide equipment, they cannot be moved prior to driving the vehicle out).

Your Trion Pro-M workstation is equipped with an Auto-electric Power Unit which features light touch, one hand operation. You will notice a slight delay from the time the motor starts running and the time the lift begins to rise. This is a normal operating characteristic of the Autoelectric Power Unit.



# TIPS FOR USING YOUR PRO-M WORKSTATION

## POSITIONING EQUIPMENT ON THE LIFT

Your Pro-M workstation will safely carry loads mounted in any position or configuration - whether backward or forward or even at an angle. Three-wheeled vehicles will require that the third wheel be placed in the wheel tray and four-wheeled vehicles will generally be placed with the smallest wheels or narrowest wheel track in the wheel tray. Most positioning considerations, however, will only be required for equipment with ROPS or canopies.

Three-wheeled vehicles will require that the third wheel be placed in the wheel tray and four-wheeled vehicles will generally be placed with the smallest wheels or narrowest wheel track in the wheel tray. Most positioning considerations, however, will only be required for equipment with ROPS or canopies.

**Overload Protection.** Trion's Pro-M has been designed with load equalizers to compensate for off-center loads. The weight capacity, however, will be reduced proportionate to any off-centered weight distribution (due to added friction on the slide blocks inside the supporting legs). Trion's overload protection detects such changes and will prevent lifting if the load is too far out of balance for the weight capacity. Should this occur, you may need to readjust your equipment to a more centered position until the overload protection releases.

## POSITIONING THE WHEEL FORKS

Trion's unique, patented, wheel forks make switching from one piece of equipment to the next a breeze. The fork holder hooks along the inside of the tool bar. Its "tilt and glide" feature (shown at right) allows you to select a convenient position at any point along the tool bar, and the weight of lifted vehicles prevents it from moving when equipment is raised. The wheel fork is fitted through the fork holder and slides easily to accommodate any wheel width.

Your Trion workstation has been designed for most equipment to be easily backed into the loading area so the rear wheel(s) drive into the wheel tray. After driving in, the two wheel forks are then positioned around the front wheels. In fact, nearly all adjustments are made with the wheel forks alone, and the wheel tray seldom ever needs to be repositioned.

Extra-wide equipment and vehicles with oversized wheels must have the wheel forks pre-positioned so the equipment can drive into the forks. The next section details this process.

## LOADING WIDE-WHEELED EQUIPMENT

Your Pro-M workstation has been equipped with Trion's exclusive Accuload Decal System. The letter and number designations that are found along the top edge of the tool bar allow you to specify exactly where the wheel tray and wheel forks should be positioned when loading your largest equipment. This avoids "trial and error" loading, which costs time and energy.



Here's how we suggest you set up the Accuload Decal System for use:

1) Determine the optimum position for the wheel tray and then measure the wheel base of the equipment to be loaded.

2) Position the wheel forks by measuring from the center of the wheel tray forward to the length of the measured equipment wheel base. (NOTE: The wheel fork

holders have an indicator arrow which may be facing either inside or outside the lift. Be sure to measure, using the arrow consistently on the side you most conveniently.)

3) Once the wheel forks are positioned, drive the vehicle into the workstation loading area and into the wheel forks and tray. If the wheels do not rest fully within the wheel forks and tray, or if the overall placement is unsatisfactory (such as when canopies or ROPS will not clear the top beam), drive the vehicle out and adjust the position of the wheel forks and/or wheel tray accordingly.

4) Once you've found the best position for that vehicle, mark one of the Positioning Guide Decals (provided) with the letter and number designations for that vehicle. Place the decal conspicuously on the vehicle as a reference for future loading. As an example, the decal shown above has been labeled B42, the position usually selected for 58" wheelbase vehicles such as the Toro 5300 or Jacobsen LF135.

If you find that you require additional decals, you may call Trion's Customer Service toll-free to order extras.



## LOADING SMALL-WHEELED EQUIPMENT

Pro-M workstations are designed to lift the widest variety of equipment possible without added complications to the loading process. Very small (8") wheels, however, such as are common to the Ryan Greensair, could fall through the wheel forks when the equipment is lifted. To prevent this possibility, fix our (8230) Small Wheel Adapters to the wheel forks, as shown in the photo below.

These adapters can be kept conveniently at the workstation with our Storage Stand Accessory, which attaches to one leg of the lift. The Storage Stand is also useful for keeping our (8201) Two-Wheel Adapter and its attachments handy at the lift.

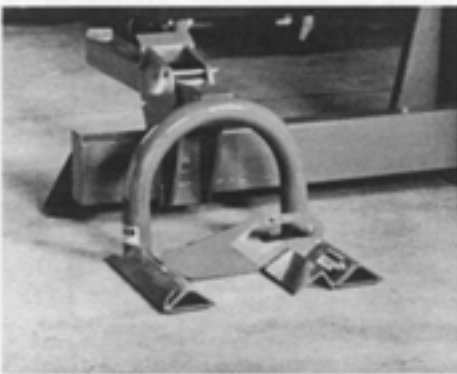

## MOVING THE WHEEL TRAY

The wheel tray is often kept at one position (usually the "B" locator slot) unless adjustment is necessary for long wheel-based equipment or to adjust placement for ROPS or canopies to clear the top beam.

When it becomes necessary to move the wheel tray, an easy method is to raise the lift approximately 6" off the floor and place our (8301) rolling shop stool under the center of the wheel tray. Then lower the lift until the wheel tray rests on the shop stool and free of the tool bar, as shown in the photo above right. Roll the tray to the new position

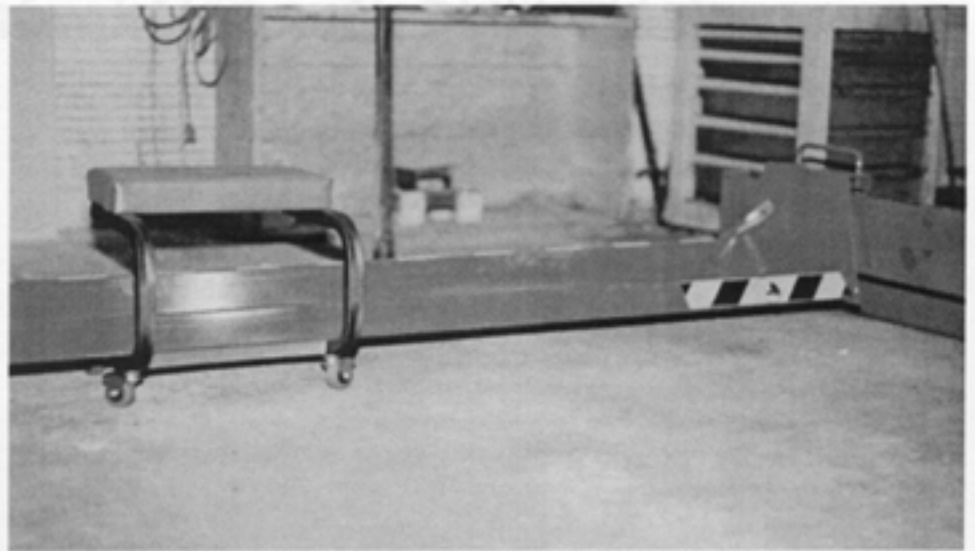

and raise the lift once again to engage the wheel tray in the appropriate locator slot on the tool bar.

## USING THE TOOL BAR EXTENSIONS (if so equipped)

The tool bar extensions will rarely, if ever, be required for raising your turf equipment. They are appropriate, however, for raising golf carts with full-length canopies and for raising road vehicles. The wheel tray may be positioned on the tool bar extensions when they are pushed in or extended to their full length. Do not, however, raise equipment with the extensions only partially pulled out as this can result in damage to the extensions.

Although your workstation is designed to carry capacity loads safely and securely on the tool bar extensions, they should be used only when required. Prudent use will avoid undue load stresses which could result in premature wear to internal lift components.

## COST-SAVING PREVENTATIVE MAINTENANCE

Trion's Pro-M workstation makes thorough, timely service possible. In fact, your expectations of equipment life and routine maintenance

demands will likely change dramatically with its use. In order to benefit most from your workstation's cost-saving features, consider the following:

- 1) Center as many service tasks as possible around the lift area. Arrange the work bay so all tools, electrical and air service are convenient to the lift.
- 2) Make it a regular practice to incorporate standard visual inspections under your equipment every day while it is being raised for reel adjustments. Such inspections take very little time when performed under raised equipment and they virtually eliminate "surprise" breakdowns and other hazards in the field.
- 3) Make oil changes and all other lubrications part of the technician's routine service using the Trion, since its complete accessibility allows all these tasks to be completed more thoroughly and in record time.
- 4) Maintain a complete service record for each piece of equipment. There are several software packages currently on the market which are customized to handle computerized service record keeping. Manual records, although perhaps more time-consuming, are equally helpful.



# MAINTAINING YOUR TRION WORKSTATION

Your Pro-M workstation has been designed to give you many years of satisfactory service with a minimum of maintenance attention. Nevertheless, certain routine service operations should be followed to assure maximum performance and avoid potential mishaps or failures.

## POWER UNIT MAINTENANCE

**Monitor Oil Levels.** Every Trion power unit is tested and filled with hydraulic oil at the factory prior to shipment. Periodically, the oil level should be observed through the sight gauge (see photo at right) with the lift fully raised. Add oil as necessary. Take care not to overfill as this may cause oil to spray from the fill cap when the lift is being operated.

When it becomes necessary to add oil, select an ISO32 hydraulic oil. You may already be using such an oil for your lightweight fairway mower's hydraulic system.

### Recommended Oil Brands

Mobile DTE 13M\*  
Conoco Super 552M  
Shell Tellus T 32  
Texaco Rando Z-36  
Chevron AW MV32  
Exxon Univas N32

\*This is the brand supplied in your workstation.

## CABLE MAINTENANCE

**Cable Inspection.** Routine annual inspections should be made in order to note any localized deterioration that may occur along the length of the cables. Conditions such as the following are sufficient to either seriously question the cable safety or immediately remove the cable from service and replace it: Broken, worn, crushed, flattened, jammed or abraded wire strands; cracked bent or worn end connections; or corrosion of the cable.

Severe stretching (as indicated by a frequent need to adjust the cables) or significant reduction in cable diameter (specifically, the portion of

the cable that moves over the pulleys) could indicate internal wire failure of the cable. This would also indicate the need for cable replacement.

Regardless of the cable's observed condition, however, it is considered wise practice to replace them every 10 years.



### Cable Lubrication.

During fabrication, wire ropes receive lubrication. This treatment will provide the finished rope with ample protection for a reasonable time. A cable filled with dirt or

grit has a reduced life and should be cleaned and re-lubricated. Light oil applied to the cable yearly will extend its service life.

**Cable Adjustment.** During early use, the cables may stretch slightly from their initial alignment. Our experience has shown that an adjustment may be necessary after the first month of operation. This frequently involves shortening the control side cables. The next adjustment may not be necessary until two years have passed. Your own experience may vary, however.

When properly adjusted, the audible click of the locking mechanism in each leg will be heard simultaneously when the lift is being raised. If

the click becomes non-synchronized, adjustment is needed. Adjustment may also be necessary if the lift fails to reach the uppermost latch of the locking mechanism.

To make an adjustment to the cables, first raise a vehicle on the lift to its full lifting height. (**NOTE: Raising the lift under load is important.**)

Observe the position of the safety dogs through the inspection openings on the inside of each lift leg. The tip of the dog should be 1/2" below the stop in each side. Cables will need to be tightened to raise the stop or loosened to lower the stop. To adjust, disengage safeties and lower the lift until the equalizer is at a convenient height and resting on the safeties. Tighten or loosen the cable nuts as required. Repeat the procedure until both dogs are 1/2" below the safety stop.

If additional adjustment is needed, check the installation of the nyloc nut on the threaded end of the safety rod in the non-control leg. While the lift is sitting on the safeties and with the safety lever on the control side resting on top of the rod, tighten until all play in the safety mechanism is removed.

Page Intentionally left blank



# TRUBLE -SHOOTING GUIDE

For your convenience, we've listed some of the most common questions we hear below, along with suggestions for correcting the problem. If you experience continued difficulty or have other service needs that are not mentioned here, please do not hesitate to call our service experts during normal business hours (8-5, M-F, Mountain Time) at 800-426-3634.

<b>If...</b>	<b>Possible Cause</b>	<b>What to Do</b>
... the lift does not raise to the last (uppermost) stop	cables may be out of adjustment	refer to cable adjustment steps outlined in the installation portion of this manual under Step 29.
...safeties do not engage simultaneously	cables may be out of adjustment	refer to cable adjustment steps outlined in the installation portion of this manual under Step 29.
...lights dim when the workstation is operating	inadequate power supply	check for adequate power
...breakers fail when raising equipment	inadequate power supply	check for adequate power
...it is slow or difficult to start or raise equipment	inadequate power supply -or- the oil level may be too low  -or- the valve or valve seat may be dirty.	check for adequate power  -or- with the lift fully raised, insure that the oil level If too low, add more oil to the proper level.  -or- clean or replace the valves according to the steps outlined
...oil shoots out of the top of the power unit when raising equipment.	the oil level may be too high	with the lift fully raised, insure that the oil level If too high, drain excess.
...the wheel forks do not lay flat on the floor	the wheel forks have not been adjusted properly.	refer to wheel fork and tool bar alignment steps outlined in the installation portion of this manual under Steps 25-26.
...the motor does not activate when trying to raise	power may have been interrupted -or- actuating switch may be faulty	check power supply -or- replace switch.
...the motor hums but will not operate	use of inadequate extension cord -or- inadequate power supply	use a 12-gauge extension cord no longer than 20 feet. -or- check for adequate power
...the lift will not raise equipment off the floor	equipment may exceed lift capacity	check equipment weight -or- shift the placement of the equipment to a more centered position (see "Positioning Equipment on the Lift" on page 22).
...the lift "drifts" down to the safety lock.	valve or valve seat may be dirty.	clean or replace the valves

# OPERATOR CERTIFICATION CHECKLIST

The checklist below is provided for your convenience. It may be duplicated for use in reviewing proper operating procedures with technicians and/or as documentation to satisfy insurance requirements. Have the technician initial each statement below to indicate agreement to the statement or satisfactory completion of its requirements.

The supervisor and operator signed below certify the following:

- 1) \_\_\_\_\_ The operator has read and thoroughly understands the safety and operating instructions detailed on pages 19 and 21 of the Pro-M workstation instruction manual.
- 2) \_\_\_\_\_ The operator has demonstrated knowledge of the weight capacity of the Pro-M workstation and the equipment which may be serviced using it.
- 3) \_\_\_\_\_ The operator knows the location and meaning of all the decals on the Pro-M workstation.
- 4) \_\_\_\_\_ The operator will always inspect the Pro-M daily for damaged or worn parts prior to use.
- 5) \_\_\_\_\_ The operator has demonstrated the ability to move equipment in and out of the work area without causing damage to the vehicle or to the Trion workstation.
- 6) \_\_\_\_\_ The operator will always properly load equipment. He/She has demonstrated proficiency in:
  - \_\_\_\_\_ properly adjusting the wheel forks prior to loading very wide equipment.
  - \_\_\_\_\_ fully engaging wheel forks.
  - \_\_\_\_\_ properly positioning vehicles on the lift for safety.
  - \_\_\_\_\_ not loading equipment that does not meet minimum tire size specifications or exceeds weight limits.
- 7) \_\_\_\_\_ The operator will always properly raise and lower equipment. He/She certifies the following:
  - \_\_\_\_\_ will not attempt to raise only a portion of a vehicle.
  - \_\_\_\_\_ will not operate lift when a person is riding in or on the vehicle to be raised.
  - \_\_\_\_\_ will check vehicle stability before raising to a full working height.
  - \_\_\_\_\_ will observe vehicle position while raising to avoid contact damage with the top beam or any other structure.
  - \_\_\_\_\_ will never attempt to remove or add any part of a raised vehicle which could cause an unbalanced or unstable condition.
  - \_\_\_\_\_ will always alert others before lowering equipment.
  - \_\_\_\_\_ will always clear the lift area of obstructions before lowering equipment.
  - \_\_\_\_\_ will always operate the lift from outside the work area.
- 8) \_\_\_\_\_ the operator will never attempt to use any component of the Pro-M for any purpose other than its designed and intended use.

\_\_\_\_\_  
supervisor's signature

\_\_\_\_\_  
print name above

\_\_\_\_\_  
date

\_\_\_\_\_  
operator's signature

\_\_\_\_\_  
print name above

\_\_\_\_\_  
date



## FIVE-YEAR LIMITED WARRANTY

All Trion products are engineered, manufactured and tested to provide many years of satisfactory performance under normal use. Trion Lifts, Inc. pledges to the original owner that, should there be any defect in material or workmanship during the first FIVE years after purchase, we will repair or replace the defective part or component promptly, at our option, and with no cost to the purchaser.

Our technicians are qualified to assist you in determining the repairs or replacement parts needed. To obtain service under this warranty, please contact the factory service department at 800-426-3634 during normal business hours and describe the defect BEFORE attempting any repair work. Failure to follow these instructions may void this warranty.

The warranty applies only to parts or components which are defective and does not cover repairs and adjustments necessary due to normal wear, misuse or accidents. Neither the sales personnel nor the seller nor any other person is authorized to make any warranty other than those described above, or to extend the duration of any warranty beyond the time period described above.

There is no other express warranty. All implied warranties of merchantability and fitness of use are limited to the duration of the express warranty.

Trion Lifts, Inc. is not liable for indirect, incidental or consequential damages in connection with the use of the product, including any cost or expenses of providing substitute equipment or service during periods of malfunction or non-use.

This warranty gives specific legal rights and you may also have other rights which vary from state to state.

We at Trion have pledged to be "Your Partner in Productivity," not only by providing you with the most efficient turf equipment lift available anywhere, but by making ourselves available to you to answer any questions or needs you may have with regard to our products.

Do you have questions about any of the installation steps outlined in this manual?

Do you need assistance in planning a new facility layout that will include your new workstation?

Do you have questions about moving your Trion workstation after initial set-up?

Do you want more information about enhancing your preventative maintenance program using your new Trion?

Do you have suggestions for various turf maintenance applications?

Our goal is your safety and satisfaction. We welcome any questions or comments you may have. Please write us at the address at right or call us during our normal business hours via the toll-free number on page 2 of this booklet.

**Trion Lifts LLC**  
**Andalusia, AL USA**  
**Turf Pride LLC**  
**334-488-3939**

