

PAR WEST



EVERYTHING YOU NEED FOR EVERY JOB ON TURF.

GOLF COURSE | IRRIGATION | LANDSCAPE | SPORTS TURF | CUSTOM SIGNAGE

WWW.PARWEST.COM

THE PAR WEST STANDARD.

WHO WE ARE



ORDER YOUR WAY.

We understand that chatbots and automated prompts are everywhere, making it harder to connect or place orders. No matter your role in turf management, we go above and beyond to ensure you get what you need—quickly, easily, and with a personal touch.



ORDER ONLINE AT
WWW.PARWEST.COM



CALL OUR
SALES DEPT DIRECTLY



CONTACT YOUR LOCAL
PAR WEST REP



EMAIL OUR
SALES DEPT

Personalized Customer Service Support
Hassle-Free Ordering
National Account Special Pricing Programs |
Net 30 Term Invoicing With Approval
Fast Shipping With In-Stock Products

REGISTER YOUR ONLINE ACCOUNT TODAY!

WWW.PARWEST.COM/MY-ACCOUNT-PAR-WEST/



@PARWESTTURF



@PARWESTTURF



@PARWESTTURF



@WEAREPARWESTTURF



@PARWESTTURF

FOLLOW US ON SOCIAL!

Connect with us on social media for the latest products, promotions, and specials only for our friends!



At Par West, we understand what it takes to keep our customers' turf on point. We have all you need to help them master their turf and every job that comes with it. With this mindset, we strive to provide our customers with unparalleled support in every aspect of managing their turf and related needs.

OUR CORE VALUES

PURPOSE – We are driven toward bettering the lives of those we interact with by the service, products, and experience provided to them.

ACTION – We take action! If we see something in need of fixing or to be done, we jump in and EXECUTE!

RESILIENT – We always adjust and re-frame to overcome any obstacle. We learn from our mistakes and strive to improve!

WILLINGNESS – We go the extra mile with the intent of leaving every situation better than we found it.

EFFECTIVE – We improve and analyze so we can best serve our customers and each other. We focus on bringing the best outcome every time!

SERVICE – We are of service to each other and who we interact with always! We lead with a selfless mindset and a HELP MORE focus.

TRUSTWORTHY – We do what we say we will do. NO exceptions!

NATIONAL SALES REP MAP

Give us a call, and we'll connect you with a local rep who's ready to provide personalized service and expert support to meet all your course maintenance needs.

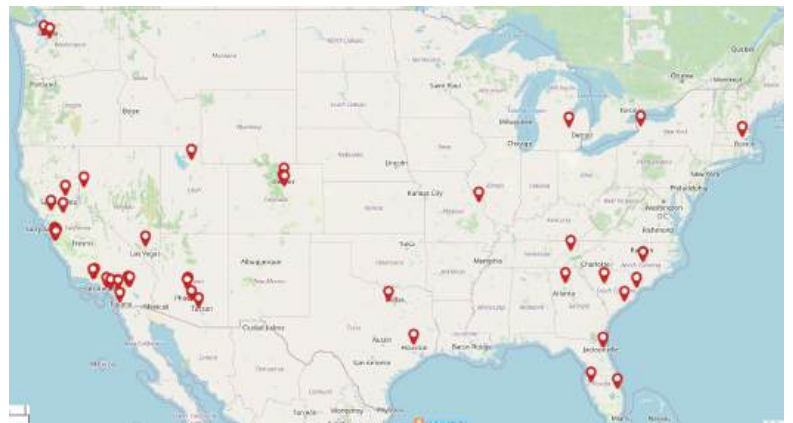

TABLE OF CONTENTS

SIGN SHOP
4-31



DRIVING RANGE & PRACTICE AREA
32-58



CLUBHOUSE FURNISHINGS
59-66



TOURNAMENT & GOLF SHOP SUPPLIES
67-72



STARTER AREA
73-75



TEE PRODUCTS
76-89



GREEN PRODUCTS
90-109



BUNKER MAINTENANCE
110-114



COURSE & YARDAGE MARKINGS
115-119



TRAFFIC CONTROL
120-123



GOLF CART PARTS & ACCESSORIES
124-125



SAFETY PRODUCTS
126-134



IRRIGATION & WATERING
135-167



AQUATIC MAINTENANCE
168-173



TURF & AGRONOMY
174-205



POWER EQUIPMENT
206-210



EQUIPMENT PARTS
211-239



MAINTENANCE SHOP SUPPLIES
240-245



NATIONAL PARTNERS



PREFERRED NATIONAL DEALER



4 PAR WEST SIGN SHOP

YOUR ULTIMATE SUPPLIER FOR CUSTOM COURSE MESSAGING.

- Custom signs for golf courses, corporate and special events
- High-quality fabric and printing hardware
- Hassle-free ordering process
- FREE art design proofs within one business day
- FREE logo vector conversion with order
- FASTEST completion and shipping time in the golf industry
- **Create eye-catching custom signs with our Perma-Core brand**

Par West is here to help you customize and create eye-catching and attractive signage, grab the attention and gain significant traction with new course customers. From graphics to text to the most minute of details, Par West is here to help you take control of all your golf course messaging and signage

Perma-Core laminate plastic products are made from high quality American 1/2 inch laminate material. We have multiple color options to choose from, resin fill for special letter coloring, and engraved or lexan logo options available. Nobody beats our turn around time on our Perma-Core plastic products!!

PERMA-CORE LAMINATE PRODUCTS



CUSTOM MESSAGE SIGNS



FAIRWAY SIGNS



TEE MARKERS



TEE SIGNS



RANGE YARDAGE TARGETS



FAIRWAY YARDAGE TARGETS



DRIVING RANGE YARDAGE EASELS



DIVOT RANGE SIGNS



DRIVING RANGE DIVIDERS



ENTER/EXIT SIGNS

CAST BRONZE & ALUMINUM PRODUCTS



TEE SIGNS



QUICK CHANGE SIGNS



YARDAGE MARKERS



TEE MARKERS

ALUMINUM GOLF COURSE SIGNS



COURSE SIGNS



GOLF COURSE TRAFFIC SIGNS

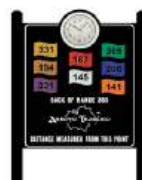

DRIVING RANGE SIGNS



SAFETY SIGNS



PREMIUM CURVED ALUMINUM SIGNS

Pricing is subject to change.



6 PAR WEST SIGN SHOP

PERMA-CORE TEE SIGNS

STEP 1 - CHOOSE YOUR SERIES & SIZE

SIGNATURE SERIES



- Discounted pricing for full course sign orders (18 holes)
- Includes logo

CLASSIC SERIES



- Discounted pricing for full course sign orders (18 holes)
- Includes logo
- Includes yardages with color fill dots

IMPERIAL SERIES

Hole Layout



- Discounted pricing for full course sign orders (18 holes) Includes logo
- Includes yardages with color fill dots
- Includes color fill hole layout



PWPC1218-S- 12" X 18"

PWPC1420-S- 14" X 20"

PWPC1824-S- 18" X 24"

PWPC1218-CS- 12" X 18"

PWPC1420-CS- 14" X 20"

PWPC1824-CS- 18" X 24"

PWPC1218-I- 12" X 18"

PWPC1420-I- 14" X 20"

PWPC1824-I- 18" X 24"

STEP 2 - CHOOSE YOUR SIGN SHAPE



STEP 3 - CHOOSE YOUR SIGN COLOR



STEP 4 - CHOOSE YOUR BORDER & LETTER COLOR FILL OPTIONS FOR CLASSIC & IMPERIAL SERIES



STEP 5 - LOGO & HOLE LAYOUT



LEXAN LOGO



ENGRAVED LOGO



RESIN COLOR FILL

SEND US YOUR SCORECARD HOLE LAYOUT FOR IMPERIAL SERIES SIGNS

Free Art Design - Free Proofs

- Send us your scorecard and logo
- Our in house art team will help you design the perfect tee sign - including various options at no charge



STEP 6 - CHOOSE YOUR SIGN MOUNT



8 FT U-CHANNEL SIGN POST

PWPOSTUCG-8

RECYCLED PLASTIC MOUNTING POST OPTIONS

5, 6, 7, Or 8 Feet Options

- Black, White, Brown, and Green Options Available.
- 4 inch x 4 inch material
- Great for Perma-core tee signs

RCPPPOST4460- 5' POST

RCPPPOST4472- 6' POST

RCPPPOST4484- 7' POST

RCPPPOST4496- 8' POST



Pricing is subject to change.

ALUMINUM DIGITAL PRINT TEE SIGNS

STEP 1 - CHOOSE YOUR SERIES & SIZE

SIGNATURE SERIES



CLASSIC SERIES



IMPERIAL SERIES

Hole Layout



- Discounted pricing for full course sign orders (18 holes)
- Includes logo

- Discounted pricing for full course sign orders (18 holes)
- Includes logo
- Includes yardages and color dots

- Discounted pricing for full course sign orders (18 holes)
- Includes logo
- Includes yardages with color dots
- Includes color hole layout

PWALS1218-S- 12" X 18"
 PWALS1420-S- 14" X 20"
 PWALS1824-S- 18" X 24"

PWALS1218-CS- 12" X 18"
 PWALS1420-CS- 14" X 20"
 PWALS1824-CS- 18" X 24"

PWALS1218-I- 12" X 18"
 PWALS1420-I- 14" X 20"
 PWALS1824-I- 18" X 24"

STEP 2 - CHOOSE YOUR SIGN SHAPE



STEP 3 - CHOOSE YOUR PRINT COLOR



STEP 5 - SEND US YOUR LOGO!

STEP 6 - HOLE LAYOUT

SEND US YOUR SCORECARD HOLE LAYOUT FOR IMPERIAL SERIES SIGNS

Free Art Design - Free Proofs



- Send us your scorecard and logo
- Our in house art team will help you design the perfect tee sign - including various options at no charge

STEP 5 - CHOOSE YOUR SIGN MOUNT



8 FT U-CHANNEL SIGN POST

PWPOSTUCG-8



RECYCLED PLASTIC MOUNTING POST OPTIONS
 5, 6, 7, Or 8 Feet Options

- Black, White, Brown, and Green Options Available.
- 4 inch x 4 inch material
- Great for aluminum tee signs

RCPOST4460- 5' POST
 RCPOST4472- 6' POST
 RCPOST4484- 7' POST
 RCPOST4496- 8' POST

CAST BRONZE AND ALUMINUM TEE SIGNS CALL FOR PRICING - DISCOUNTED PRICING FOR FULL COURSE SIGN ORDERS

STEP 1 - CHOOSE YOUR SERIES & SIZE



SIGNATURE SERIES

- Discounted pricing for full course sign orders (18 holes)
- Includes logo
- Choose post and background colors

| | |
|---------------|--------------------|
| PC-TS-1218-BZ | 12" X 18" BRONZE |
| PC-TS-1218-AL | 12" X 18" ALUMINUM |
| PC-TS-1420-BZ | 14" X 20" BRONZE |
| PC-TS-1420-AL | 14" X 20" ALUMINUM |
| PC-TS-1824-BZ | 18" X 24" BRONZE |
| PC-TS-1824-AL | 18" X 24" ALUMINUM |



CLASSIC SERIES

- Discounted pricing for full course sign orders (18 holes)
- Includes logo
- Choose post and background colors
- Includes yardages

| | |
|---------------|--------------------|
| PC-TC-1218-BZ | 12" X 18" BRONZE |
| PC-TC-1218-AL | 12" X 18" ALUMINUM |
| PC-TC-1420-BZ | 14" X 20" BRONZE |
| PC-TC-1420-AL | 14" X 20" ALUMINUM |
| PC-TC-1824-BZ | 18" X 24" BRONZE |
| PC-TC-1824-AL | 18" X 24" ALUMINUM |



IMPERIAL SERIES Hole Layout

- Discounted pricing for full course sign orders (18 holes)
- Includes logo
- Choose post and background colors
- Includes hole layout & yardages

| | |
|---------------|--------------------|
| PC-TI-1218-BZ | 12" X 18" BRONZE |
| PC-TI-1218-AL | 12" X 18" ALUMINUM |
| PC-TI-1420-BZ | 14" X 20" BRONZE |
| PC-TI-1420-AL | 14" X 20" ALUMINUM |
| PC-TI-1824-BZ | 18" X 24" BRONZE |
| PC-TI-1824-AL | 18" X 24" ALUMINUM |

- A picture perfect hole starts with the right tee set-up. What do your tees say about your golf course?
- Cast aluminum or bronze tee signs are a classically elegant, and surprisingly affordable, way to designate your tees.
- Choose the style and features you want and our artists will create renderings quickly and at no charge.



STEP 2 - CHOOSE YOUR SIGN SHAPE



STEP 3 - CHOOSE YOUR POST & CAP 8 Foot Aluminum Posts



STEP 4 - CHOOSE YOUR MOUNTING STYLE

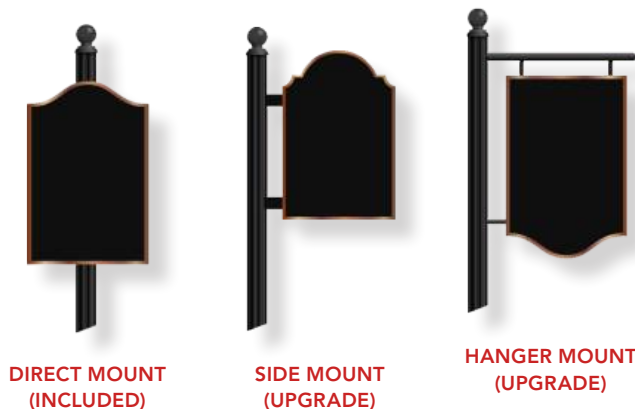

Pricing is subject to change.

CAST BRONZE OR ALUMINUM COURSE DIRECTIONAL SIGNS

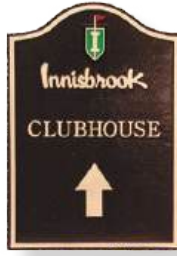

- PCDS-1012-BZ 10" X 12" BRONZE SIGN
- PCDS-1012-AL 10" X 12" ALUMINUM SIGN
- PCDS-1014-BZ 10" X 14" BRONZE SIGN
- PCDS-1014-AL 10" X 14" ALUMINUM SIGN
- PCDS-1218-BZ 12" X 18" BRONZE SIGN
- PCDS-1218-AL 12" X 18" ALUMINUM SIGN
- PCDS-1420-BZ 14" X 20" BRONZE SIGN
- PCDS-1420-AL 14" X 20" ALUMINUM SIGN
- PCPOST-SQ-33-06 6 FOOT ALUMINUM POST

- Cast metal signage is a tasteful and elegant way to communicate course direction with your patrons.
- Combine your logo with one of our many shapes and sizes available.
- Use up to 30 characters per sign (minimum letter size of 1")

ALUMINUM SIGN POST

- 6 feet tall
- 3 inch x 3 inch material
- Durable and weather resistant powder coated Aluminum
- Works with plastic signs or Aluminum signs
- Top ball cap sold separately

- PCPOST-SM-0306 3 INCH X 3 INCH BLACK SQUARE POST
- PCFN-1033 3 INCH DECORATIVE BALL CAP FINIAL

ADDITIONAL SIGN POST CAPS



- 3" BALL CAP
- 3" FLAT CAP
- 4" BALL CAP- UPGRADE
- 4" FLAT CAP- UPGRADE



CAST BRONZE & ALUMINUM QUICK CHANGE SIGNS

Cast Bronze Or Cast Aluminum

- Quick change signs can be used to update cart rules, hole locations, yardages or Green speeds.
- Brass plates can be used to update just about any information you want to communicate to your golfers
- Plates sold separately
- Let our in house artists help you design the perfect sign for you

CALL FOR PRICING

- PCCR-1214-BZ 12" X 14" BRONZE SIGN
- PCCR-1214-AL 12" X 14" ALUMINUM SIGN
- PCCR-1420-BZ 14" X 20" BRONZE SIGN
- PCCR-1420-AL 14" X 20" ALUMINUM SIGN
- PCCR-1824-BZ 18" X 24" BRONZE SIGN
- PCCR-1824-AL 18" X 24" ALUMINUM SIGN
- PCPOST-SQ-33-06 6 FOOT ALUMINUM POST



PERMA-CORE QUICK CHANGE SIGNS

We also make Perma-core Quick Change Signs out of our signature laminate plastic. Call us to find more information or get a quote!

*See page 27 for more post options.



10 PAR WEST SIGN SHOP

CUSTOM STONE COURSE MESSAGING

Made in The USA

- Stone-look tee signs, tee markers, directional signs, and entry monuments
- Manufactured in resin-cast, concrete-cast, or precision-cut metal (select applications)
- Choose the look: sandstone, granite, woodgrain, or smooth color finish
- Designed for the outdoors: tough, long-wearing, and damage-resistant
- Built from premium USA-sourced raw materials for consistent quality
- From short runs to highly custom one-offs—every order can be customized
- CAD-designed and fabricated with waterjet + CNC routing for clean, repeatable detail
- Standard lead time: ~6 weeks (confirm at time of quote)

Par West helps you create course messaging that looks natural and reads beautifully without sacrificing durability. Our stone-style signs are crafted in the USA using high-quality resin or concrete mixes (or cut metal where needed) and finished to mimic sandstone, granite, wood, or a sleek smooth color. Every project is built from the ground up using computer-aided design, then precision-cut and routed with waterjet and CNC equipment for dependable results. We don't stock "one-size-fits-all" inventory. Your order is made to match your course, your branding, and your exact needs.

STONE TEE SIGNS



HOW IT WORKS

- 1) Choose a style + finish
- 2) Review CAD proof
- 3) Precision manufacture
- 4) Delivered ready for install

STONE TEE MARKERS



STONE DIRECTIONAL SIGNS



STONE ENTRY SIGNS



READY TO UPGRADE YOUR COURSE MESSAGING?

Talk to your Par West rep to start a custom layout and quote.

Pricing is subject to change.

12X6 PERMA-CORE SMALL FAIRWAY SIGNS

Single Piece With Double Steel Spikes



- 12" x 6" PLASTIC sign won't fade, warp or fail
- Full 1/2" thick material with stainless steel spikes
- Engraved letters - color-fill available
- Single sided message
- Choose from our stock colors or special order other colors
- Custom Message Available!

SIGN COLOR OPTION KEY

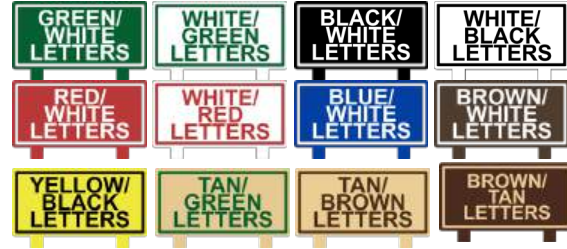

- PWPC4 SINGLE-SIDED
- PWPC4D DOUBLE-SIDED
- PWPC5A ARROW (REVERSIBLE)

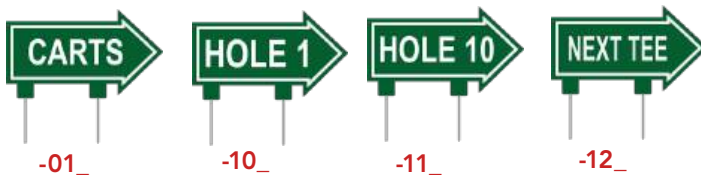
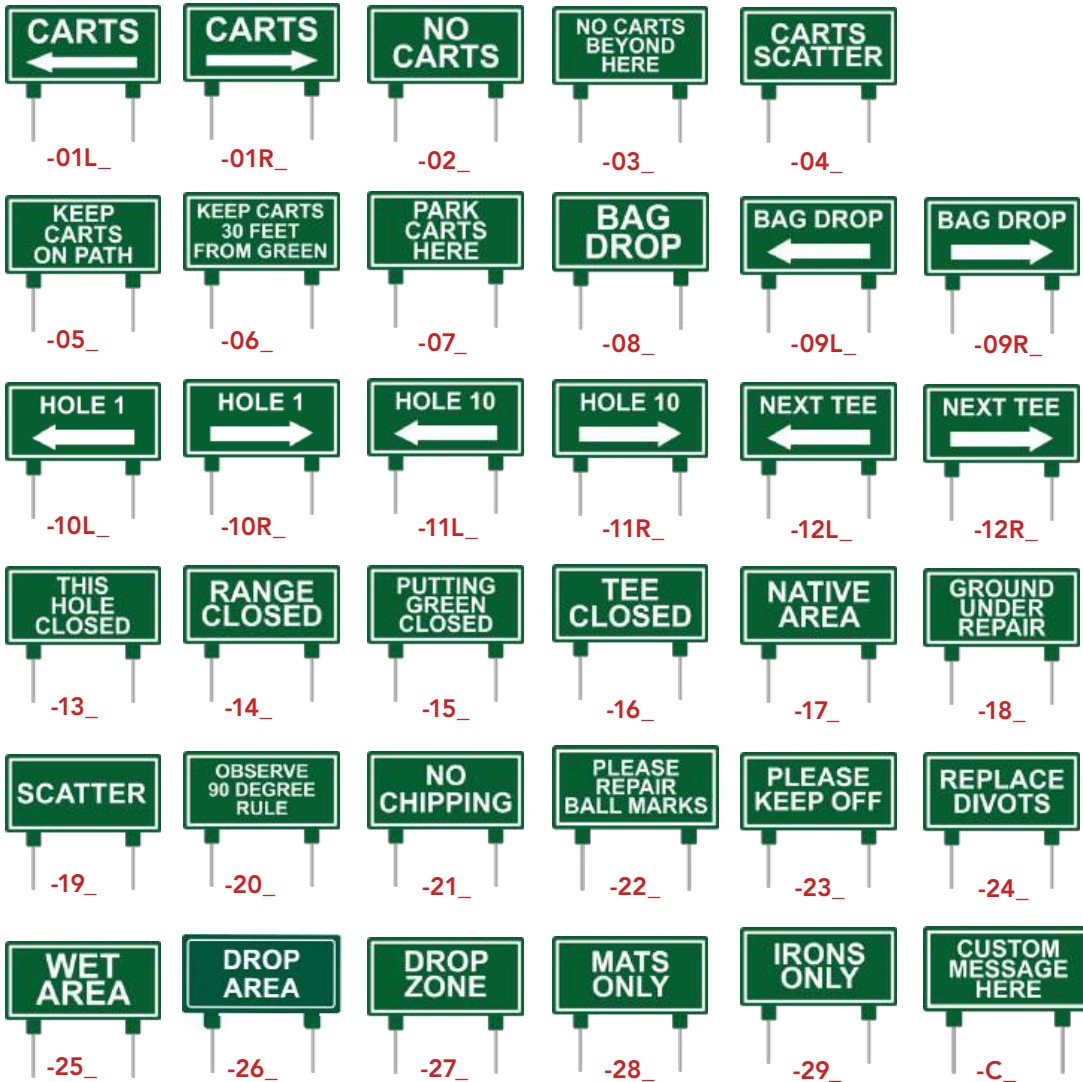

PERMA-CORE SINGLE SPIKE AIRWAY SIGNS

Comes in 1/2" and 1/4" Options

- 10" x 5" plastic sign won't fade, is extremely durable and weather resistant
- Single sided messages
- Cart with reversible arrow is double-sided
- Choose from our stock colors or special order other colors
- Custom Message Available!

SIGN COLOR OPTION KEY

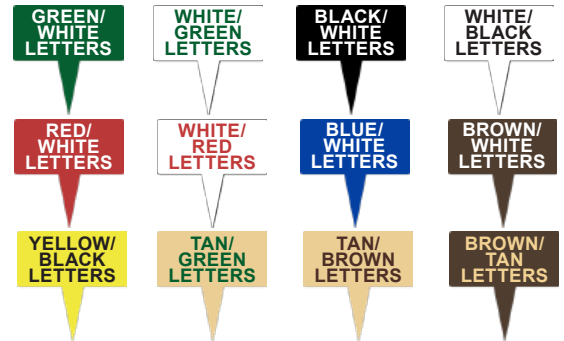

* Our 1/4" signs are a more economical option, but not as durable as the 1/2" option.



- PWPC5** 1/2" SINGLE-SIDED
- PWPC5D** 1/2" DOUBLE-SIDED
- PWPC5E** *1/4" SINGLE-SIDED
- PWPC5DE** *1/4" DOUBLE-SIDED

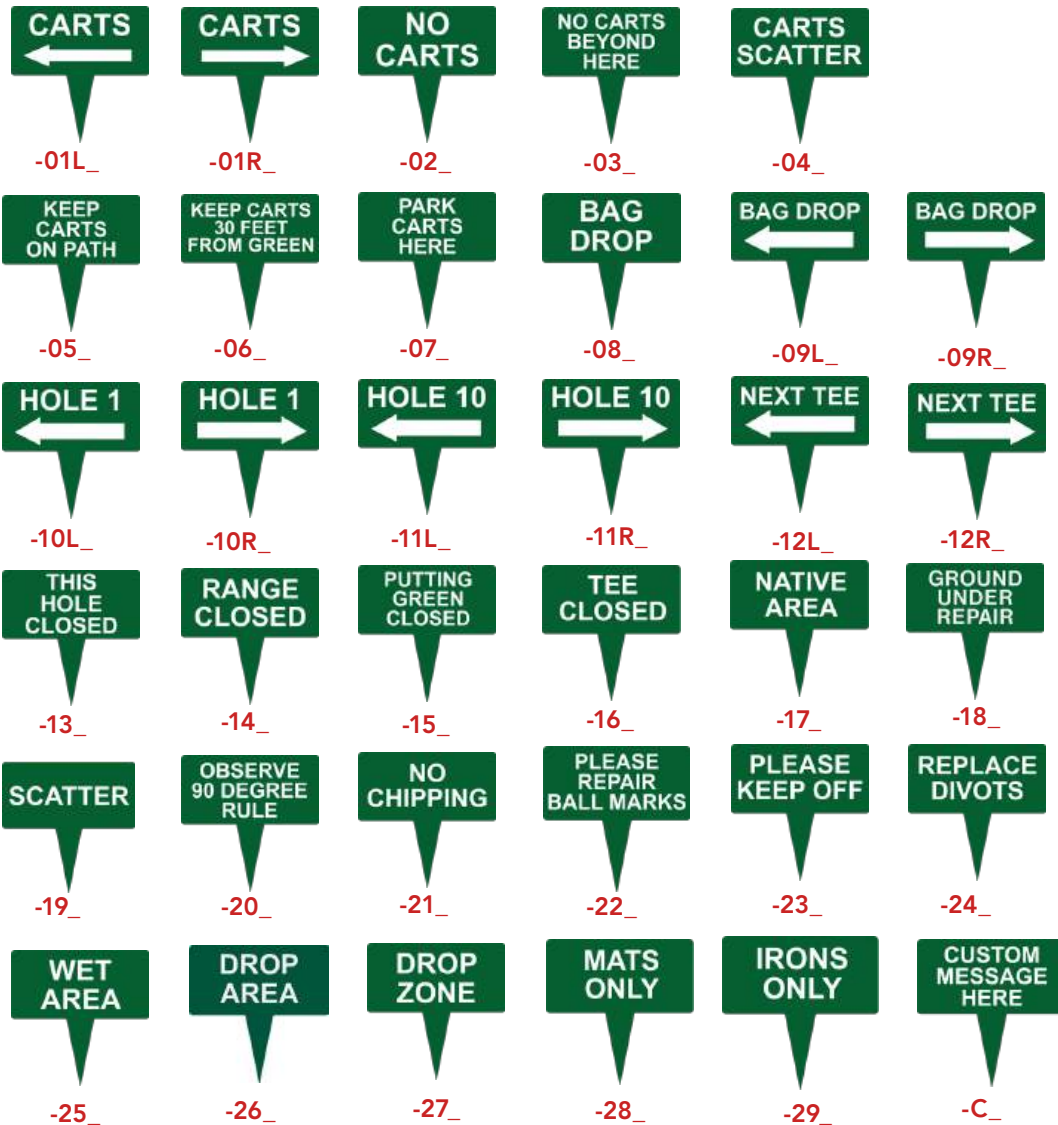

15X9 PERMA-CORE LARGE FAIRWAY SIGNS

Single Piece With Double Steel Spikes



- 15" x 9" plastic sign won't fade, warp or fail
- Full 1/2" thick material with stainless steel spikes
- Engraved letters - color-fill available
- Single sided and double-sided messages
- Choose from our stock colors or special order other colors
- Custom Message Available!

PWPC3 SINGLE-SIDED

PWPC3D DOUBLE-SIDED

SIGN COLOR OPTION KEY

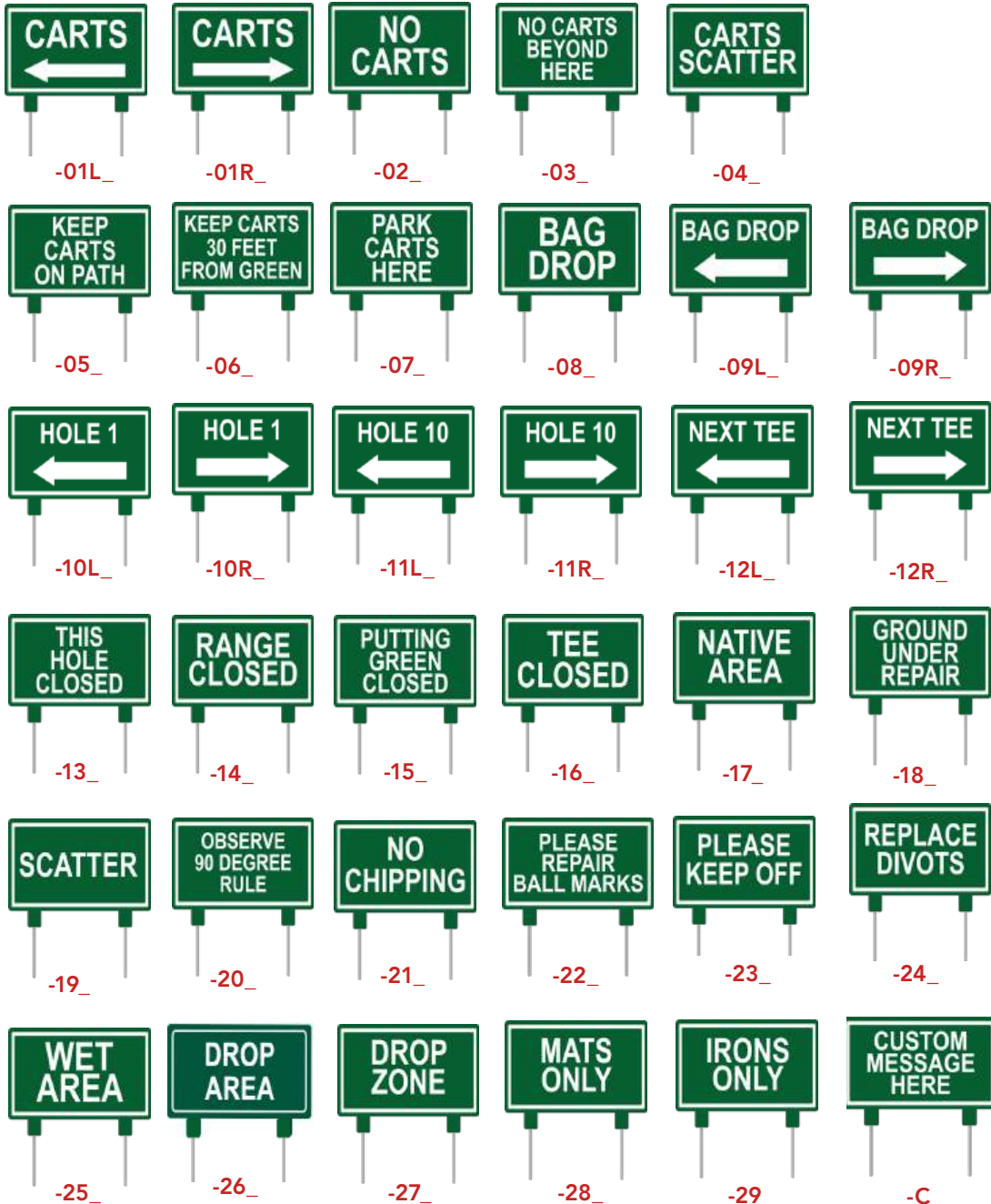

PERMA-CORE DELUXE OVAL FAIRWAY HANDLE SIGNS



- 12" x 9" Oval sign w/ handle
- 1/2" thick
- Engraved letters
- Choose stock colors or we can special order any color

SIGN COLOR OPTION KEY



- PWPC2 SINGLE-SIDED - DOUBLE SPIKE
- PWPC2D DOUBLE-SIDED - DOUBLE SPIKE
- PWPC2-S12 SINGLE-SIDED - 12-INCH STAKE
- PWPC2D-S12 DOUBLE-SIDED - 12-INCH STAKE
- PWPC2-S18 SINGLE-SIDED - 18-INCH STAKE
- PWPC2D-S18 DOUBLE-SIDED - 18-INCH STAKE

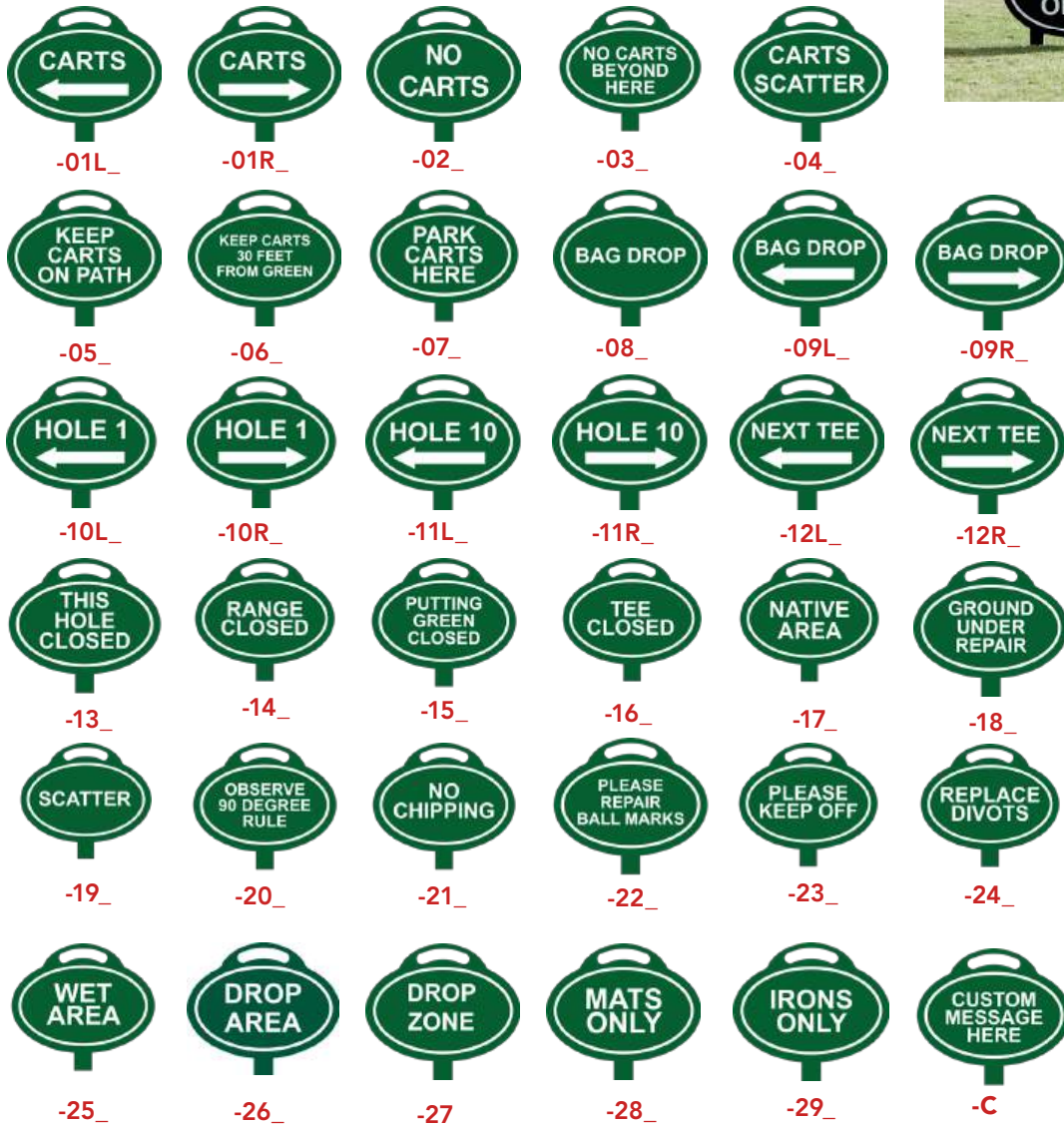

PORTABLE RECYCLED LUMBER SIGN POSTS
12" & 18" Options



- PWRPS-400-30 GREEN
- PWRPS-800-30 BLACK
- PWRPS-200-30 WHITE

Pricing is subject to change.

ALUMINUM DOUBLE SPIKE FAIRWAY SIGNS



- Always custom messages - you choose it, we make it - no art fees or extra charges
- Great looking sign - less expensive than plastic
- Don't get stuck with limited messages in plastic signs
- Choose between two color schemes
- Always double-sided messages - no extra charge
- Fairway sign is 9" wide x 4.5" tall
- Arrow sign is 15" long x 4" tall

SIGN COLOR OPTION KEY



PWALS4D DOUBLE-SIDED

PWALS4-A ARROW (REVERSIBLE)

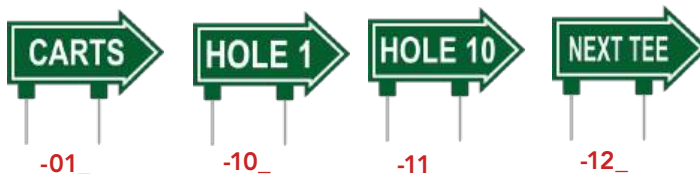
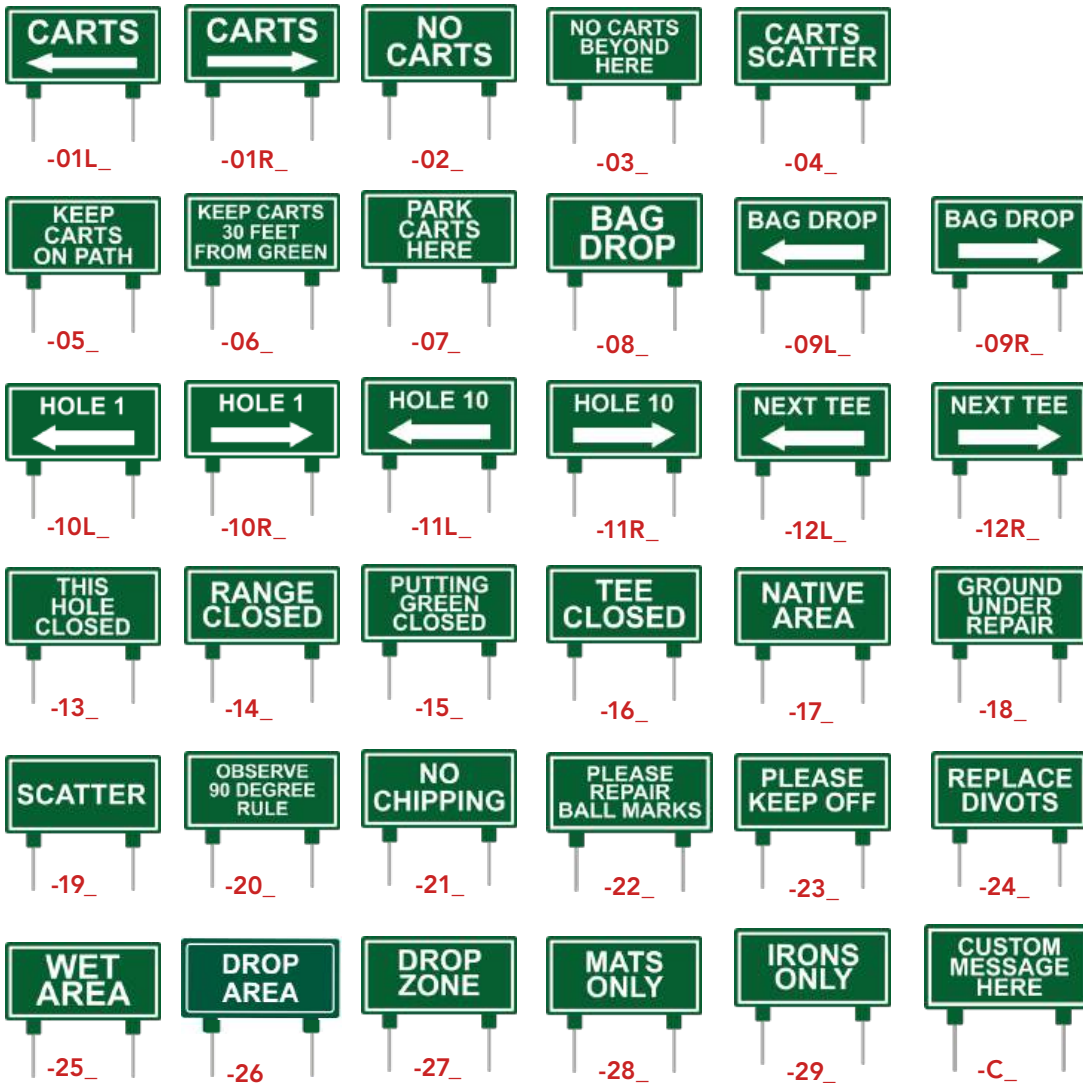

ALUMINUM SINGLE SPIKE FAIRWAY SIGNS



- 10" x 6" Aluminum sign
- 1/8" thick
- One-piece construction for greater durability
- Powder-coated finish
- Double sided message

SIGN COLOR OPTION KEY



- _ = ENTER LETTER IN FINAL SPOT WHITE/GREEN & BROWN/WHITE SIGNS COLOR OPTIONS

GCA7D-

| | | | | | |
|-------|-------|-------|-------|-------|-------|
| | | | | | |
| -01L_ | -01R_ | -02_ | -03_ | -04_ | |
| | | | | | |
| -05_ | -06_ | -07_ | -08_ | -09L_ | -09R_ |
| | | | | | |
| -10L_ | -10R_ | -11L_ | -11R_ | -12L_ | -12R_ |
| | | | | | |
| -13_ | -14_ | -15_ | -16_ | -17_ | -18_ |
| | | | | | |
| -19_ | -20_ | -21_ | -22_ | -23_ | -24_ |
| | | | | | |
| -25_ | -26_ | -27_ | -28_ | -29_ | -C |



Pricing is subject to change.

DURA-FLEX PLASTIC SIGNS



- Indestructible course communications.
- Our exclusive Dura-Flex Signs survive years of punishment from wayward carts and whatever else your course can dish out.
- Thick, flexible and maintenance-free material with raised 3D lettering and a molded-in continuous spike.
- A wide selection of standard messages and colors are available.
- 10 1/2 in. x 5 1/2 in. (27 cm x 14 cm) (not including spike)

SIGN COLOR OPTION KEY



PAR5610-

PAR5620-

PAR5630-



- | | |
|-----------------------------|----------------------------|
| 01 GROUND UNDER REPAIR | 13 NO CHIPPING |
| 02 TEE AREA CLOSED | 14 NEXT TEE |
| 03 NO CARTS PAST HERE | 16 NO CARTS |
| 04 KEEP CARTS ON PATH | 17 < CARTS |
| 05 PLEASE RAKE BUNKERS | 18 CARTS > |
| 06 PLEASE REPAIR BALL MARKS | 19 < NEXT TEE |
| 07 DROP AREA | 20 NEXT TEE > |
| 08 WET AREA CARTS KEEP OFF | 21 PLEASE OBSERVE 90° RULE |
| 09 PLEASE REPLACE DIVOTS | 22 TROLLEYS > |
| 10 PLEASE KEEP OFF | 23 < TROLLEYS |
| 11 CARTS SCATTER | 24 NO TROLLEYS |
| 12 PUTTING GREEN CLOSED | 25 DROP ZONE |

WOOD DIRECTIONAL SIGNS



- Give your golf course a timeless, traditional look with our new hardwood signs
- Each sign is individually hand-oiled to maintain a rich, hardwood color
- Can be easily refurbished by applying teak oil
- Letters are routed and painted black
- Stainless steel spikes
- 10 3/8 in. x 5 3/8 in. x 3/4 in. (26 cm x 14 cm x 2 cm)

PAR5660

SINGLE-SIDED MESSAGES

PAR5660-50

CARTS > (DOUBLE-SIDED)

- | | |
|-----------------------------|----------------------------|
| 01 GROUND UNDER REPAIR | 13 NO CHIPPING |
| 02 TEE AREA CLOSED | 14 NEXT TEE |
| 03 NO CARTS PAST HERE | 16 NO CARTS |
| 04 KEEP CARTS ON PATH | 17 < CARTS |
| 05 PLEASE RAKE BUNKERS | 18 CARTS > (DOUBLE-SIDED) |
| 06 PLEASE REPAIR BALL MARKS | 19 < NEXT TEE |
| 07 DROP AREA | 20 NEXT TEE > |
| 08 WET AREA CARTS KEEP OFF | 21 PLEASE OBSERVE 90° RULE |
| 09 PLEASE REPLACE DIVOTS | 22 TROLLEYS > |
| 10 PLEASE KEEP OFF | 23 < TROLLEYS |
| 11 CARTS SCATTER | 24 NO TROLLEYS |
| 12 PUTTING GREEN CLOSED | 25 DROP ZONE |



PERMA-CORE ENTER/EXIT SIGNS

OVAL ENTER/EXIT SIGNS

10" x 7" Sign on 18" Sign Post

PWPC-EN18- ENTER SIGN

PWPC-EX18- EXIT SIGN

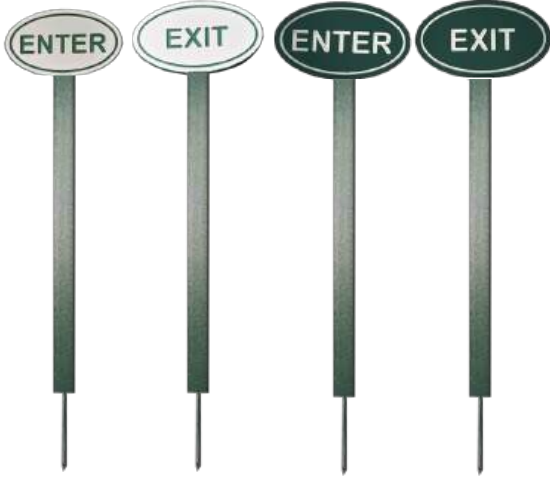

ENTER/EXIT SIGN COLOR OPTION KEY



PORTABLE RECYCLED LUMBER SIGN POSTS
18" Options

PWRPS-400-30 GREEN

PWRPS-800-30 BLACK

PWRPS-200-30 WHITE

Custom Stake Size Options Available!

VERTICAL ENTER/EXIT SIGNS

32" x 3.5"

PWPC-EN- ENTER SIGN

PWPC-EX- EXIT SIGN



ENTER/EXIT SIGN COLOR OPTION KEY

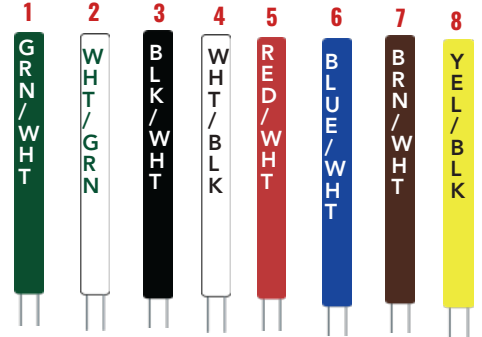

ENTER/EXIT FLAGS

32" x 3.5"

PWTPF-EN TRAFFIC POST - ENTER

PWTPF-EX TRAFFIC POST - EXIT

PWTPF-C TRAFFIC POST W/ CUSTOM FLAG

PWRPS-800-12-YT 12" TRAFFIC CONTROL STAKE (CASE OF 25)

Custom options available.



Pricing is subject to change.

VERTICAL MESSAGE SIGNS

32" x 3.5"

- PWPVMS-MESSAGE-COLOR STANDARD MESSAGE
- PWPVMS-CUSTOM-COLOR CUSTOM MESSAGE



SIGN COLOR OPTION KEY

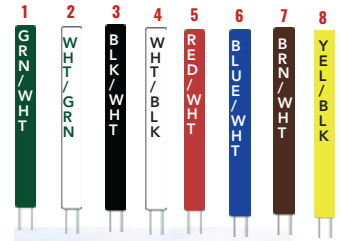

VERTICAL YARDAGE SIGNS

32" x 3.5"

- PWPVYS-50-1 GREEN 50
- PWPVYS-75-2 WHITE 75
- PWPVYS-100-5 RED 100
- PWPVYS-150-3 BLACK 150
- PWPVYS-200-4 BLUE 200
- PWPVYS-250-8 YELLOW 250
- PWPVYS-C_ CUSTOM NUMBER

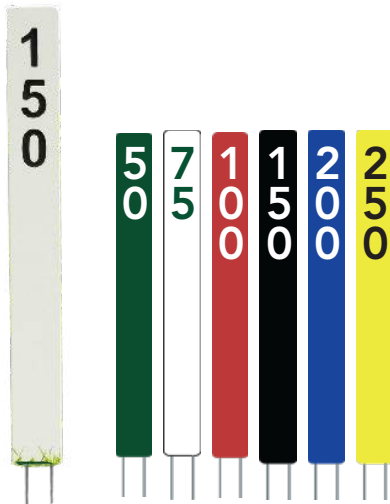

SIGN COLOR OPTION KEY

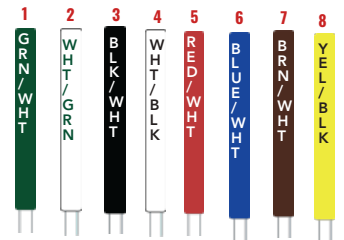

VERTICAL HAZARD SIGNS

32" x 3.5"

- PWPVHS-RD LATERAL WATER HAZARD
- PWPVHS-YW REGULAR WATER HAZARD
- PWPVHS-BL GROUND UNDER REPAIR
- PWPVHS-WH OUT OF BOUNDS
- PWPVHS-C_ CUSTOM MESSAGE

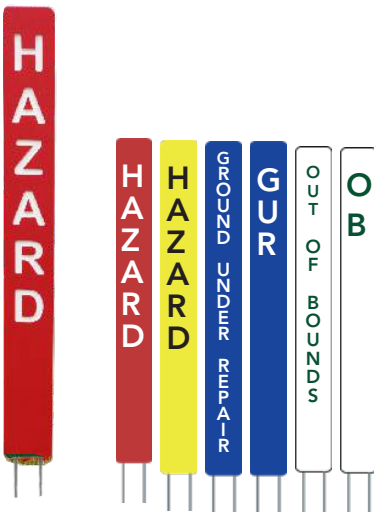

SIGN COLOR OPTION KEY



12X12 PERMA-CORE COURSE INFORMATIONAL SIGNS

1/2" *1/4"

- PWPC1212-5 IN-STOCK INFORMATIONAL SIGN (SEE BELOW)
- PWPC1212-1 CUSTOMIZED ONE COLOR
- PWPC1212-2 CUSTOMIZED TWO COLORS
- PWPC1212-3 CUSTOMIZED THREE COLORS

WE WAIVE ALL ART FEES TO SAVE YOU THE HASSLE OF TIME AND MONEY WITH CREATING YOUR CUSTOM SIGN MESSAGES!

SIGN COLOR OPTION KEY



PWPC1212-101-__



PWPC1212-121-__



PWPC1212-116-__



PWPC1212-112-__



PWPC1212-126-__



PWPC1212-103-__



PWPC1212-104-__



PWPC1212-114-2



* Our 1/4" signs are a more economical option, but not as durable as the 1/2" option.



PWPC1212-123-__



PWPC1212-109-__



PWPC1212-110-__



PWPC1212-125-__



PWPC1212-304-__



PWPC1212-301-__



PWPC1212-305-__



PWPC1212-119-__



PWPC1212-113-__



PWPC1212-111-__



PWPC1212-130-__

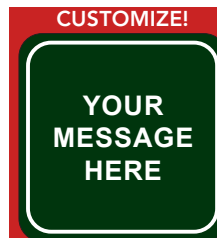

PWPC1212-C

PORTABLE RECYCLED LUMBER SIGN POSTS

30" Posts

- PWRPS-400-30 GREEN
- PWRPS-800-30 BLACK
- PWRPS-200-30 WHITE



RECYCLED PLASTIC MOUNTING POST OPTIONS

5, 6, 7, Or 8 Feet Options



- Black, White, Brown, and Green Options Available.
- 4 inch x 4 inch material
- Great for perma-core plastic signs

- RCPOST4460-__ 5' POST
- RCPOST4472-__ 6' POST
- RCPOST4484-__ 7' POST
- RCPOST4496-__ 8' POST

See other sign post options on page 27!

12X18 PERMA-CORE COURSE INFORMATIONAL SIGNS

1/2" *1/4"

- PWPC1218-5 IN-STOCK INFORMATIONAL SIGN (SEE BELOW)
- PWPC1218-1 CUSTOMIZED ONE COLOR
- PWPC1218-2 CUSTOMIZED TWO COLORS
- PWPC1218-3 CUSTOMIZED THREE COLORS

WE WAIVE ALL ART FEES TO SAVE YOU THE HASSLE OF TIME AND MONEY WITH CREATING YOUR CUSTOM SIGN MESSAGES!

SIGN COLOR OPTION KEY



PWPC1218-109-__



PWPC1218-105-__



PWALS1218-102-__



PWPC1218-303-__



PWPC1218-304-__



PWPC1218-C

Looking for a Personalized Message?
 We'll Customize Any of Our Signs Or Make Any Message You Need. Reach Out to Us for a Proof Within 1 Business Day At No Charge!
 *See page 19 for more post options.

PORTABLE RECYCLED LUMBER SIGN POSTS

30" Posts

- PWRPS-400-30 GREEN
- PWRPS-800-30 BLACK
- PWRPS-200-30 WHITE

RECYCLED PLASTIC MOUNTING POST OPTIONS

5, 6, 7, Or 8 Feet Options

- Black, White, Brown, and Green Options Available.
- 4 inch x 4 inch material
- Great for perma-core plastic signs

- RCPOST4460-__ 5' POST
- RCPOST4472-__ 6' POST
- RCPOST4484-__ 7' POST
- RCPOST4496-__ 8' POST

See other sign post options on page 27!

PERMA-CORE ENGRAVED SIGNS

STEP 1 - CHOOSE YOUR COLOR

Choose Between Our 12 Color Options



- 1 GREEN WITH WHITE LETTERS
- 2 WHITE WITH GREEN LETTERS
- 3 BLACK WITH WHITE LETTERS
- 4 BLUE WITH WHITE LETTERS
- 5 RED WITH WHITE LETTERS
- 6 WHITE WITH RED LETTERS
- 7 WHITE WITH BLACK LETTERS
- 8 BROWN WITH WHITE LETTERS
- 9 YELLOW WITH BLACK LETTERS
- 10 TAN WITH GREEN LETTERS
- 11 TAN WITH BROWN LETTERS
- 12 BROWN WITH TAN LETTERS

STEP 2 - CHOOSE YOUR SHAPE AND SIZE

Choose from Our Common Sizes Or We Can Create Any Custom Shape Or Size!

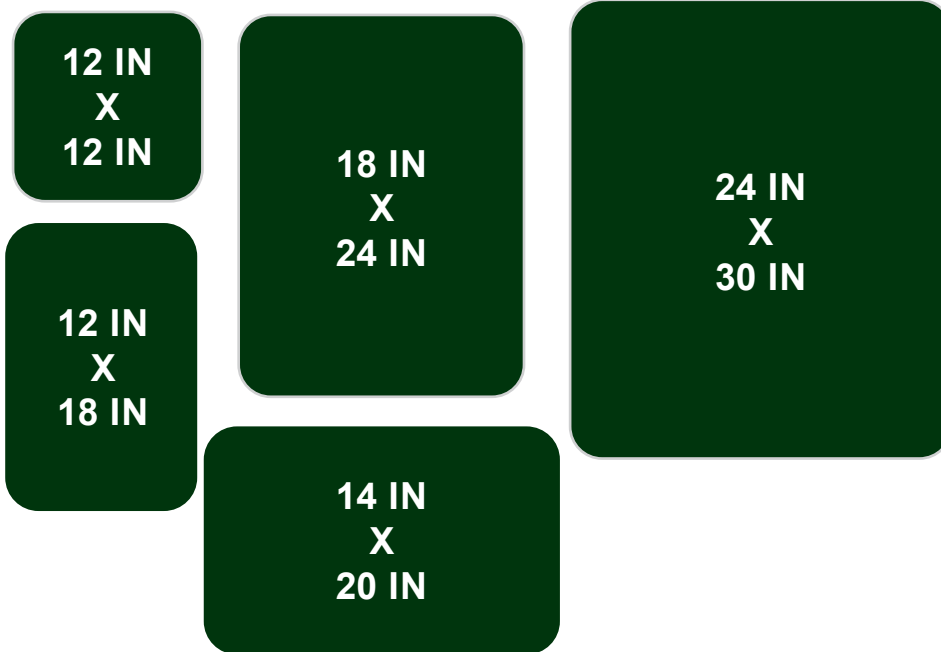

PREMIUM CURVED SERIES

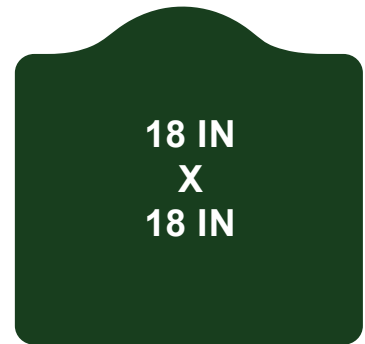

PREMIUM CURVED SERIES



STEP 3 - ADD YOUR FINAL TOUCHES AND WE WILL START THE ARTWORK FOR YOU

| PART NUMBER | DESCRIPTION |
|-------------|------------------------------------|
| PWPC1212-C | 12 X 12 PERMA CORE CUSTOM SIGN |
| PWPC1218-C | 12 X 18 PERMA CORE CUSTOM SIGN |
| PWPC1420-C | 14 X 20 PERMA CORE CUSTOM SIGN |
| PWPC1824-C | 18 X 24 PERMA CORE CUSTOM SIGN |
| PWPC2430-C | 24 X 30 PERMA CORE CUSTOM SIGN |
| PWPC1424C-C | 14 X 24 PREMIUM CURVED CUSTOM SIGN |
| PWPC1818C-C | 18 X 18 PREMIUM CURVED CUSTOM SIGN |

We'll customize any of our signs or make any message you need. Reach out to us for a quote and FREE proof within 1 business day at no charge!



Logos, color fill and special shapes will increase the cost of a sign. We will always give you a full quote and production proof before starting any job.

*All signs are 1/2" thick as standard. 3/4" thick available upon request.

Pricing is subject to change.

12X12 ALUMINUM COURSE INFORMATIONAL SIGNS

PWAL1212- IN-STOCK INFORMATIONAL SIGNS \$40.00



PWALS1212-101



PWALS1212-121



PWALS1212-112



PWALS1212-113



PWALS1212-126



PWALS1212-102



PWALS1212-104

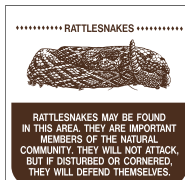

PWALS1212-103



PWALS1212-116



PWALS1212-114



PWALS1212-111



PWALS1212-109



PWALS1212-110



PWALS1212-123



PWALS1212-119



PWALS1212-108



PWALS1212-1310



PWALS1212-123C



PWALS1212-125



PWALS1212-207



PWALS1212-204



PWALS1212-124



PWALS1212-303



PWALS1212-C



PORTABLE STEEL SIGN POSTS



- Pre-drilled to hold our 12" x 12" signs or 12" x 18" signs

STD10400 40" TALL

STD10418 18" TALL

8 FT U-CANNEL SIGN POST



PWPOSTUCG-8

See other sign post options on page 27!

12X18 ALUMINUM INFORMATIONAL SIGNS

PWALS1218- IN-STOCK INFORMATIONAL SIGNS



PWALS1218-108-__



PWALS1218-101



PWALS1218-109-__



PORTABLE STEEL SIGN POSTS



PWALS1218-302



PWALS218-105



PWALS218-102



- Pre-drilled to hold our 12" x 12" signs or 12" x 18" signs

STD10400 40" TALL

STD10418 18" TALL



PWALS1218-303-__



PWALS1218-304-__



PWALS1218-C

8 FT U-CHANNEL SIGN POST



PWPOSTUCG-8

See other sign post options on page 27!

DESIGN YOUR OWN PW SERIES CUSTOM ALUMINUM SIGN

Step 1 - Choose Your Colors



GREEN & WHITE

GREEN & GOLD

BLACK & GOLD

WHITE & GREEN

STEP 2 - CHOOSE YOUR SIZE

Pick from Our In-Stock Sizes - Or You Can Order Any Custom Size Or Shape

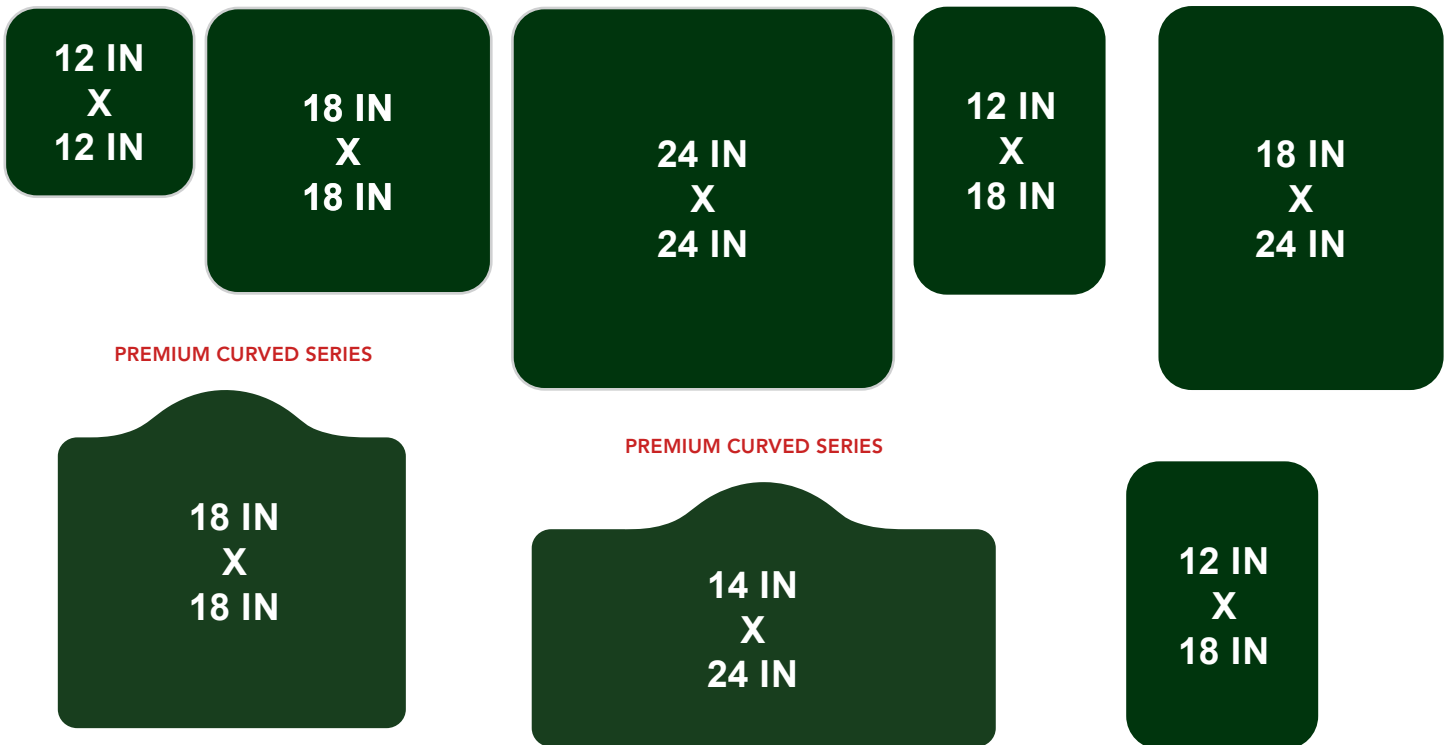

PREMIUM CURVED SERIES

PREMIUM CURVED SERIES

STEP 3 - ADD YOUR DETAILS

Tell Us Your Message - Add Your Logo and a Border - Customize to Your Needs

| PART NUMBER | DESCRIPTION |
|----------------|-------------------------------|
| PWALS1212-C | 12 X 12 PW SERIES CUSTOM SIGN |
| PWALS1218-C | 12 X 18 PW SERIES CUSTOM SIGN |
| PWALS1818-C | 18 X 18 PW SERIES CUSTOM SIGN |
| PWALS1824-C | 18 X 24 PW SERIES CUSTOM SIGN |
| PWALS2424-C | 24 X 24 PW SERIES CUSTOM SIGN |
| PWALS1424C-CUS | 14 X 24 PREMIUM CURVED SIGN |
| PWALS1818C-CUS | 18 X 18 PREMIUM CURVED SIGN |

We'll customize any of our signs or make any message you need. Reach out to us for a quote and FREE proof within 1 business day at no charge!



*PRICES MAY INCREASE WITH MORE DIFFICULT LOGOS OR SPECIAL FEATURES



HAZARDOUS MATERIALS DIAMOND SIGNS

OSHA Compliant

- Complete kit available on a 12" x 12" Aluminum sign or as a vinyl decal kit
- Each kit comes with 3 of each number 0-4 and 1 of each word/symbol - oxy, alk, acid, W

PWALS1212-205 12" ALUMINUM SIGN KIT

PWVL-NUM NUMBER & SYMBOL KIT ONLY



MAINTENANCE SHOP SIGNS

Choose Aluminum Or Perma-Core Laminate Plastic



PORTABLE STEEL SIGN POSTS

- Pre-drilled to hold our 12" x 12" signs or 12" x 18" signs

STD10400 40" TALL

STD10418 18" TALL

PERMA-CORE COLOR OPTION KEY



| | |
|-------------------|------------------|
| PWPC1212- | 12X12 PERMA-CORE |
| PWALS1212- | 12X12 ALUMINUM |
| PWPC1218- | 12X18 PERMA-CORE |
| PWALS1218- | 12X18 ALUMINUM |

| PART NUMBER | MATERIAL | MESSAGE |
|------------------------|---------------|---------------------------|
| PWALS218-202 | ALUMINUM | TURF MAINTENANCE FACILITY |
| PWPC1218-202-1 | GREEN PLASTIC | TURF MAINTENANCE FACILITY |
| PWPC1218-202-2 | WHITE PLASTIC | TURF MAINTENANCE FACILITY |
| PWALS1212-206 | ALUMINUM | SUPERINTENDENTS OFFICE |
| PWPC1212-206-1 | GREEN PLASTIC | SUPERINTENDENTS OFFICE |
| PWPC1212-206-2 | WHITE PLASTIC | SUPERINTENDENTS OFFICE |
| PWALS1212-202 | ALUMINUM | UNAUTHORIZED PERSONS |
| PWPC1212-202-1 | GREEN PLASTIC | UNAUTHORIZED PERSONS |
| PWPC1212-202-2 | WHITE PLASTIC | UNAUTHORIZED PERSONS |
| PWALS1218-201 | ALUMINUM | PRIVATE PROPERTY |
| PWPC1218-201-1 | GREEN PLASTIC | PRIVATE PROPERTY |
| PWPC1218-201-2 | WHITE PLASTIC | PRIVATE PROPERTY |
| PWALS1218-203 | ALUMINUM | REQUIRED SAFETY GEAR |
| PWALS1218-203-1 | GREEN PLASTIC | REQUIRED SAFETY GEAR |
| PWALS1218-203-2 | WHITE PLASTIC | REQUIRED SAFETY GEAR |

8 FT U-CHANNEL SIGN POST

- Pre-drilled to hold our 12" x 12" signs or 12" x 18" signs

PWPOSTUCG-8



RECYCLED PLASTIC SIGN POSTS
5, 6, 7, or 8 Feet Options



- 5, 6, 7, or 8 Feet Options
- Black, White, Brown, and Green Options Available.
- Call for custom color.
- 4 inch x 4 inch material
- Durable and weather resistant - great for Perma-core plastic signs or Aluminum signs
- Decorative beveled top

BLACK WHITE BROWN GREEN



-BK -WH -BR -GR

RCPPOST4460_ 5' POST

RCPPOST4472_ 6' POST

RCPPOST4484_ 7' POST

RCPPOST4496_ 8' POST

Note- recommended to order 2ft over desired height for 5 & 6ft options. Post may lower 2ft upon install of sign posts.

ALUMINUM SIGN POSTS



- 6 feet tall
- 3 inch x 3 inch material
- Durable and weather resistant powder coated Aluminum
- Works with plastic signs or Aluminum signs
- Top ball cap sold separately

PCPOST-SM-0306 3 INCH X 3 INCH BLACK SQUARE POST

PCFN-1033 3 INCH DECORATIVE BALL CAP FINIAL

PORTABLE RECYCLED LUMBER SIGN POSTS

30" Posts



- Made right here in our facility with the highest quality recycled plastic material
- 30 inches tall and come with a 6 inch spike so you can move sign anywhere you need it
- Perfect fit for 12" x 12" or 12" x 18" signs
- Custom sizes available

PWRPS-400-30 GREEN

PWRPS-800-30 BLACK

PWRPS-200-30 WHITE

PORTABLE STEEL SIGN POSTS



- Made of durable steel to move signs wherever needed
- Pre-drilled to hold our 12" x 12" signs or 12" x 18" signs

STD10400 40" TALL

STD10418 18" TALL

8 FT U-CHANNEL SIGN POST



- Green baked enamel u-channel posts resist corrosion.
- Tapered end easily drives into the ground.
- 3/8" Holes on 1" centers to easily attach signs.
- Meets mutcd standards.
- Pair with custom aluminum course signs. Sold separately.

PWPOSTUCG-8

PERMA-CORE IN GROUND ROUND YARDAGE MONUMENTS

Comes With Two Stainless Steel Spikes
6", 8", 11" & 15" Options

- PWPCRN-YARDAGE- SIZE-COLOR NUMBERED MONUMENT
- PWPCRN-C- SIZE-COLOR CUSTOM MONUMENT
- PWPCRN-P- SIZE-COLOR PLAIN MONUMENT

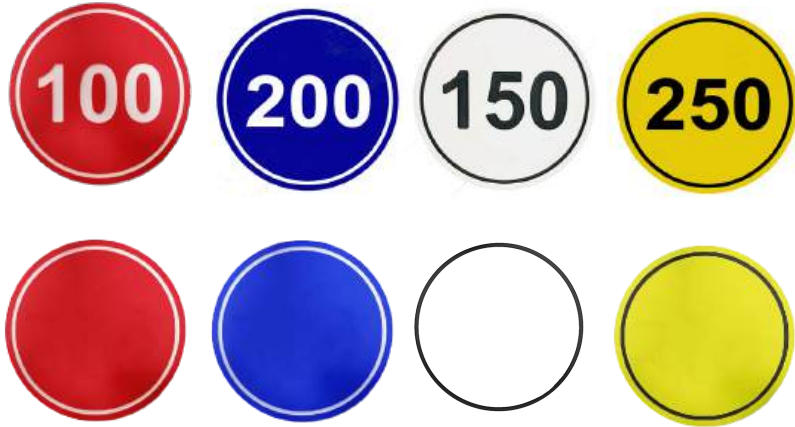

Call us for a quote for additional color options. Add logo to any marker above at additional cost.



PERMA-CORE COLOR OPTION KEY



PERMA-CORE IN GROUND RECTANGLE YARDAGE MONUMENTS

Comes With Two Stainless Steel Spikes
8" X 12"

- PWPCRC-YARDAGE-COLOR NUMBERED MONUMENT
- PWPCRC-C-COLOR CUSTOM MONUMENT
- PWPCRC-P-COLOR PLAIN MONUMENT

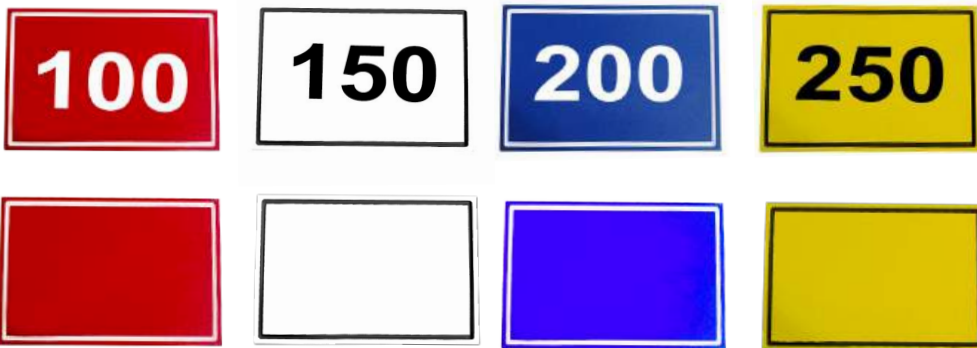

Call us for a quote for additional color options. Add logo to any marker above at additional cost.

PERMA-CORE COLOR OPTION KEY

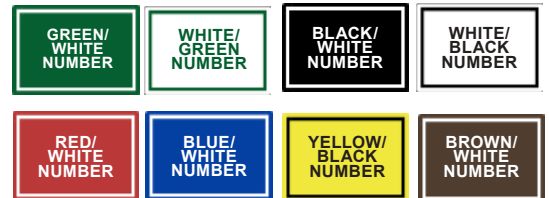

YARDAGE EASELS

Made of our premium Perma-core 1/2 inch thick material. Use the color chart on the left for available options. Flag colors and custom logos are also available to add.

EASEL COLOR OPTION KEY



LARGE DELUXE YARDAGE EASELS

32" X 22" - Single Or Double Sided

- PWPCYE-COLOR-SS-4 SINGLE SIDED - 4 YARDAGE
- PWPCYE-COLOR-SS-5 SINGLE SIDED - 5 YARDAGE
- PWPCYE-COLOR-SS-6 SINGLE SIDED - 6 YARDAGE
- PWPCYE-COLOR-SS-7 SINGLE SIDED - 7 YARDAGE
- PWPCYE-COLOR-DS-4 DOUBLE SIDED - 4 YARDAGE
- PWPCYE-COLOR-DS-5 DOUBLE SIDED - 5 YARDAGE
- PWPCYE-COLOR-DS-6 DOUBLE SIDED - 6 YARDAGE
- PWPCYE-COLOR-DS-7 DOUBLE SIDED - 7 YARDAGE



SMALL ECONOMY YARDAGE EASELS

16" X 24" - Single Or Double Sided

- PWPCEYE-COLOR-SS-4 SINGLE SIDED - 4 YARDAGE
- PWPCEYE-COLOR-DS-4 DOUBLE SIDED - 4 YARDAGE

YARDAGE EASEL NUMBERS

Replacement Slider Numbers



- Sold in a set of 50 Numbers broken down in the following quantities:

Qty 8 each of #'s 0,5
 Qty 6 each of # 1
 Qty 4 each of #'s
 2,3,4,6,7,8,9

- Aluminum is white and numbers are Black
- 3 in Dimensions – 3 inches tall x 2.25 inches wide

GCASN3 3 IN TALL

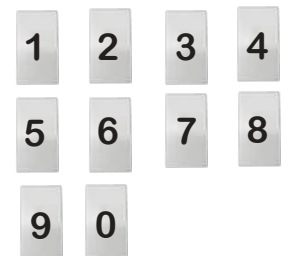

CLOCK EASEL WITH YARDAGES

40" X 32" - Single Or Double Sided

- PWPCEY-COLOR-SS SINGLE SIDED - 6 YARDAGE
- PWPCEY-COLOR-DS DOUBLE SIDED - 6 YARDAGE

CUSTOMIZE YOUR OWN RANGE EASEL!



LOOKING FOR A PERSONALIZED EASEL?

We'll Customize Any of Our easels with your logo. Reach Out to Us for a Proof Within 1 Business Day At no Charge!

CLOCK EASEL- ECONOMY

24" Tall x 16" Wide

- Perma core plastic easel with clock included
- Add logo for extra charge



PWPC-CE-SS- _ SINGLE SIDED

PWPC-CE-DS- _ DOUBLE SIDED

EASEL COLOR OPTION KEY



CLOCK EASEL- DELUXE

32" Tall x 24" Wide

- Perma core plastic easel with clock included
- Add logo for extra charge



PWPCDCE-SS- _ SINGLE SIDED

PWPCDCE-DS- _ DOUBLE SIDED



CLUBHOUSE AND STARTER SIGNS WITH CLOCKS

SHAPE 11



SHAPE 4



SHAPE 2



SIGN COLOR OPTION KEY



- Available in 12 color options
- Can be mounted to a post, hung from metal post, or mounted to wall.
- Mounting sold separately.
- Messages can be modified to fit your needs
- Add color option to end of part number

PWPC1424SC-S11_ 14" X 24" PLEASE KEEP PACE OF PLAY - SHAPE 11

PWPC1424SC-S4_ 14" X 24" PLEASE KEEP PACE OF PLAY - SHAPE 4

PWPC1424SCS-S2_ 14" X 24" TODAY'S COURSE RULES W/ SLIDERS- SHAPE 2

PWPC2436SCS-S2_ 24" X 36" TODAY'S COURSE RULES W/ SLIDERS- SHAPE 2

RECYCLED PLASTIC MOUNTING POST OPTIONS

5, 6, 7, Or 8 Feet Options



- Black, White, Brown, and Green Options Available.
- 4 inch x 4 inch material
- Great for perma-core plastic signs

RCPPOST4460- _ 5' POST

RCPPOST4472- _ 6' POST

RCPPOST4484- _ 7' POST

RCPPOST4496- _ 8' POST

See other sign post options on page 27!

CLOCKS ONLY

STD200900 WHITE, 12" - OUTDOOR WATER RESISTANT

STD200902 ATOMIC SILVER, 18" - OUTDOOR WATER RESISTANT

STD200901 BROWN, 15"

Pricing is subject to change.



PERMA-CORE RANGE DIVOT PATTERN SIGN

Plastic Sign With Two Spikes
12" H x 18" W



PWPC1218-301- SINGLE SIDED

PWPC1218-301D- DOUBLE SIDED



SIGN COLOR OPTION KEY



PERMA-CORE RANGE DIVOT PATTERN SIGN

Free Standing Plastic Easel
24" H x 16" W



PWPCE-301- BLACK SINGLE SIDED

PWPCE-301D- BLACK DOUBLE SIDED



EASEL COLOR OPTION KEY



PERMA-CORE RANGE DIVOT PATTERN SIGN

Plastic Sign Mounted on 18" Stake
12" H x 18" W



PWPC1218-301-3S SINGLE SIDED

PWPC1218-301D-3S DOUBLE SIDED

SIGN COLOR OPTION KEY



PW SERIES ALUMINUM DIVOT PATTERN SIGNS

Can Be Mounted TO Portable Sign Posts



PWALS1212-302 12"X12"



PWALS1218-301 12"X18"

PORTABLE RECYCLED LUMBER SIGN POSTS

30" Stakes

PWRPS-400-30 GREEN

PWRPS-800-30 BLACK

PWRPS-200-30 WHITE

PORTABLE STEEL SIGN POSTS

STD10400 40" TALL

STD10418 18" TALL

- Pre-drilled to hold our 12" x 12" signs or 12" x 18" signs

See other sign post options on page 27!

THE "SANDBAGGER" RANGE PICKER

The Picker You Want As A Partner



- Made in the U.S.A - Made from electroplated steel specifically for corrosion prevention and resistance to all outdoor elements.
- Designed to be the longest lasting picker on the market today!
- No front wheel - make sharp turns and maneuver without destruction to range grasses.
- No welding - all parts bolt together so you never have to cut and weld something to replace a part.
- Gangs won't tangle! Never risk leaving the vehicle to untangle gangs!
- 12" discs for the toughest picking and weather conditions! Made from extremely strong polycarbonate plastic for strength and flexibility. Plus, the added protection from our Green pigment reflects UV rays helping to extend discs' life.
- Split drum turning system - combined with our lightweight frame, each 34-disc drum is split into two 17 disc sections allowing picker to provide superior maneuverability on any terrain.
- 1800 ball capacity- 9 foot wide
- FREE 2 day shipping on all parts.

DREBPSB-3 3 SECTION - 9' WIDE - 1800 BALL

DREBPSB-5 5 SECTION - 15' WIDE - 3000 BALL



THE "ACE" RANGE PICKER

Big Ranges Need Big Pickers



- Made in the U.S.A - Made from electroplated steel specifically for corrosion prevention and resistance to all outdoor elements.
- Designed to be the longest lasting picker on the market today!
- No front wheel - make sharp turns and maneuver without destruction to range grasses.
- No welding - all parts bolt together so you never have to cut and weld something to replace a part.
- Gangs won't tangle! Never risk leaving the vehicle to untangle gangs!
- 14" oversized discs for the toughest picking and weather conditions! Made from extremely strong polycarbonate plastic for strength and flexibility. Plus, the added protection from our Green pigment reflects UV rays helping to extend discs' life.
- Split drum turning system - combined with our lightweight frame, each 34-disc drum is split into two 17 disc sections allowing picker to provide superior maneuverability on any terrain.
- 2700 ball capacity- 15 foot wide
- FREE 2 day shipping on all parts.

DREBPA-3 3 SECTION - 15' WIDE - 2700 BALL

DREBPA-5 5 SECTION - 25' WIDE - 4500 BALL

This picker is the perfect choice for medium to high volume driving ranges. An extra 6 feet of coverage provides capacity for 2,700 balls for great picking efficiency.

Pricing is subject to change.

BALL COMB



DREBP14-1 SANDBAGGER SERIES

DREBP14-2 ACE SERIES

BASKET STRAP



DREBP19

NOSE BEARING



DREBP25

PICKER AXLE BRACKETS

DREBP12-1 SANDBAGGER SERIES

DREBP12-2 ACE SERIES



DREBPA-1 1 SECTION - 5' WIDE - 900 BALL

THE "LOB WEDGE" RANGE PICKER

Small Range Essential

This single section ball picker is a Dynamic Solution for the Smaller Range. It Packs All of the Same Quality As Its Big Brothers, But Comes in a Compact Package.

- Made in the U.S.A - Made from electroplated steel specifically for corrosion prevention and resistance to all outdoor elements.
- We designed our discs for the toughest picking and weather conditions! Made from extremely strong polycarbonate plastic for strength and flexibility. Plus, the added protection from our Green pigment reflects UV rays helping to extend discs' life.
- Compact design maneuvers easily around trees, target Greens, bunkers and yardage signs.
- 900 ball capacity- 5 foot wide
- FREE 2 day shipping on all parts.



CONVERSION KIT

Convert 3 Gang to 5 Or 7 Gang Pickers

DREBPCK-1 CONVERSION KIT - SANDBAGGER

DREBPCK-2 CONVERSION KIT - ACE SERIES

- 2 Extension Arms
- 2 Extension Brackets
- 2 Drum Assemblies
- 4 Baskets
- All Hardware



*** EXPEDITED SHIPPING UPON REQUEST - WE HAVE ALL THE PARTS YOU NEED WHEN YOUR PICKER IS DOWN AND YOU NEED THEM RIGHT AWAY.**

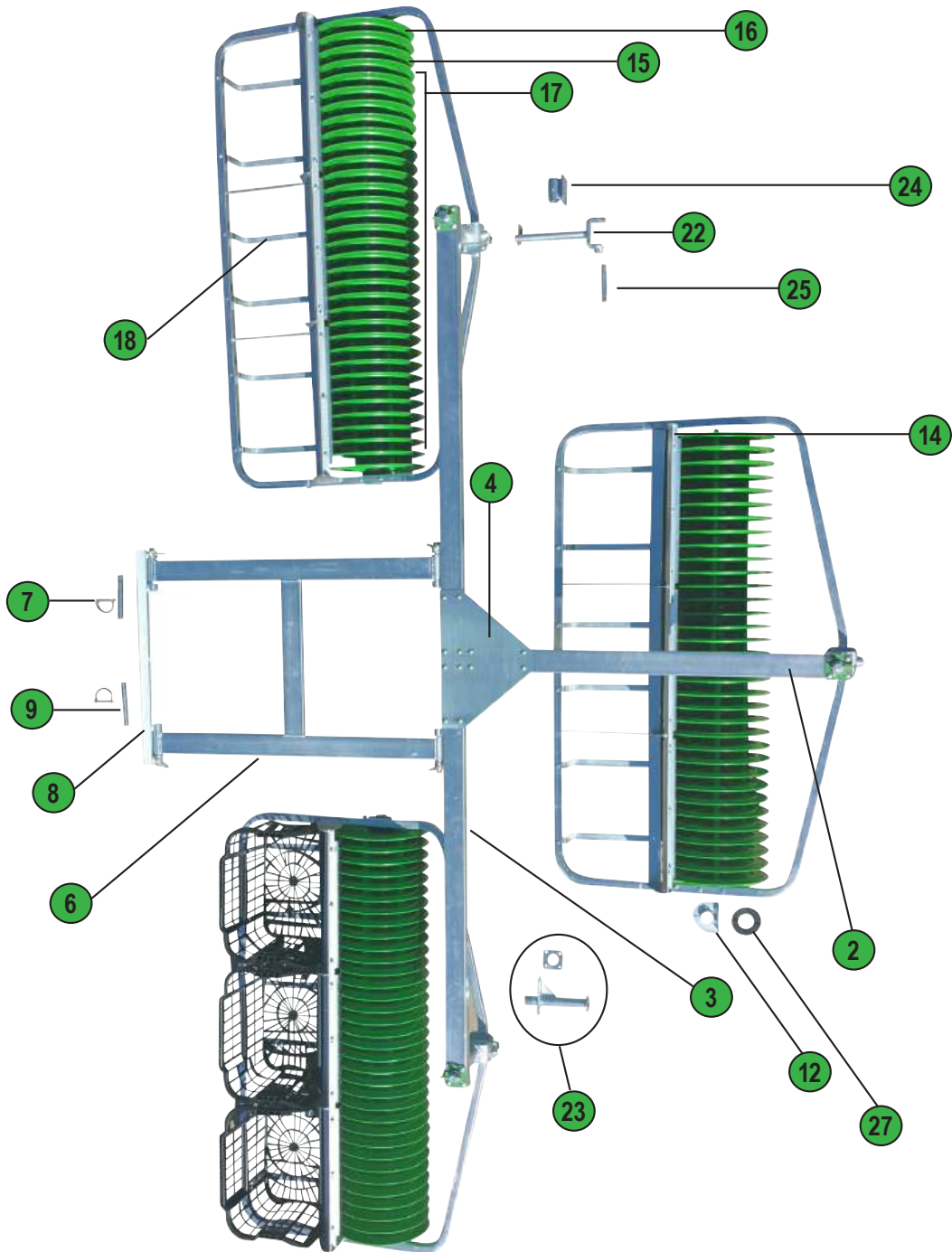

* EXPEDITED SHIPPING UPON REQUEST - WE HAVE ALL THE PARTS YOU NEED WHEN YOUR PICKER IS DOWN AND YOU NEED THEM RIGHT AWAY.

Pricing is subject to change.

PARTS LIST FOR SANDBAGGER AND ACE SERIES PICKERS

| | SANDBAGGER PART # | ACE SERIES PART # | DESCRIPTION | SANDBAGGER PRICE | ACE SERIES PRICE |
|----|-------------------|-------------------|--|------------------|------------------|
| 1 | DREBP01 | DREBP01-2 | CENTER FRAME COMPLETE (INCLUDES 1 EA OF ITEM #2 AND 2 EACH OF ITEM #3) | | |
| 2 | DREBP02 | DREBP02-2 | CENTER FRAME CENTER | | |
| 3 | DREBP03 | DREBP03-2 | CENTER FRAME LEFT/RIGHT | | |
| 4 | DREBP04 | DREBP04-2 | CENTER GUSSET SET | | |
| 5 | DREBP05 | DREBP05-2 | PUSH SECTION COMPLETE (INCLUDES ITEMS 6-9) | | |
| 6 | DREBP06 | DREBP06-2 | PUSH SECTION ONLY (NO PUSH BAR) | | |
| 7 | DREBP07 | DREBP07-2 | ¾" PUSH BAR PIN | | |
| 8 | DREBP08 | DREBP08 | PUSH BAR | | |
| 9 | DREBP09 | DREBP09-2 | LYNCH PIN | | |
| 10 | DREBP10 | DREBP10-2 | FRAME WITH HARDWARE (NO DRUM OR BASKETS) | | |
| 11 | DREBP11 | DREBP11-2 | PICKER AXLE | | |
| 12 | DREBP12-1 | DREBP12-2 | PICKER AXLE BRACKETS (PAIR) | | |
| 13 | DREBP13 | DREBP13-2 | THREADED ROD WITH NUT | | |
| 14 | DREBP14-1 | DREBP14-2 | PICKER COMB | | |
| 15 | DREBP15 | DREBP15-2 | PICKER DISC | | |
| 16 | DREBP16 | DREBP16-2 | END DISC | | |
| 17 | DREBP17 | DREBP17-2 | 23 DISC SET COMPLETE | | |
| 18 | DREBP19 | DREBP19 | BASKET BAR | | |
| 19 | DREBP20 | DREBP20-2 | EXTENSION ARM COMPLETE (NOT PICTURED) | | |
| 20 | DREBP21 | DREBP21 | EXTENSION BRACKET (NOT PICTURED) | | |
| 21 | DREBP22 | DREBP22 | EXTENSION PIN (NOT PICTURED) | | |
| 22 | DREBP23 | DREBP23 | U-JOINT | | |
| 23 | DREBP24 | DREBP24 | U-JOINT BARREL | | |
| 24 | DREBP25 | DREBP25 | NOSE BEARING | | |
| 25 | DREBP26 | DREBP26 | NOSE BEARING PIN | | |
| 26 | DREBP27 | DREBP27-2 | PICKER SECTION COMPLETE (NO BASKETS) | | |
| 27 | DREBP31 | DREBP31-2 | SLIP DISK/RETAINING PLATE | | |

*** EXPEDITED SHIPPING UPON REQUEST - WE HAVE ALL THE PARTS YOU NEED WHEN YOUR PICKER IS DOWN AND YOU NEED THEM RIGHT AWAY.**

REPLACEMENT DRUMS

Our high quality drums not only fit our pickers, but we have options that fit many of the other pickers out there. Why settle for inferior drums on a picker you already have when you can buy our replacement drums with our premium disks (sometimes cheaper than factory direct).



- DREBP17** SANDBAGGER REPLACEMENT DRUM - 23 DISCS
- DREBP17-2** ACE REPLACEMENT DRUM - 34 DISCS (14" DISC)
- DREDR01** 21 DISK REPLACEMENT DRUM - FITS EASY PICKER
- DREDR02** 21 DISK REPLACEMENT DRUM AXLE - FITS WESTERN & EASY PICKER
- DREDR03** 21 DISK REPLACEMENT DRUM - FITS WITTEK EAGLE LITE
- DREDR04** 22 DISK REPLACEMENT DRUM - FITS WITTEK RANGE ROVER AND BALL HAWK PICKERS (INCLUDES AXLE & 2 PILLOW BLOCK BEARINGS)
- DREDR05** 21 DISK REPLACEMENT DRUM - FITS HOLLROCK
- DREDR06** 23 DISK REPLACEMENT DRUM - FITS DERONE
- DREDR07** 34 DISK REPLACEMENT DRUM - FITS DERONE (14" DISC)
- STD82000** STANDARD GOLF REPLACEMENT DRUM



REPLACEMENT DISKS

- DREBP15** SANDBAGGER SERIES PICKER DISC
- DREBP15-2** ACE SERIES PICKER DISC



REPLACEMENT BASKETS

Our Baskets Also Fit Wittek and Derone Pickers.

- DREBP29** REPLACEMENT BASKET - PLASTIC

CART MOUNT BRACKETS

- DRECB10** CART BRACKET PIN
- DREBP08** PUSH BAR
- DRECB04** UNIVERSAL CART BRACKET
- DRECB03** JOHN DEERE GATOR BRACKET (2016 & OLDER)
- DRECB14** JOHN DEERE GATOR BRACKET
- DRECB21** JOHN DEERE HDX BRACKET
- DRECB09** EZ-GO 4X4 XD BRACKET (2013 & NEWER)
- DRECB12** EZ-GO RXV BRACKET
- DRECB08** CUSHMAN HAULER BRACKET (2013)
- DRECB06** KUBOTA TRACTOR MOUNT (2013 & NEWER)
- DRECB07** KUBOTA UTILITY CART BRACKET (2015 & NEWER)
- DRECB01** CLUB CAR BRACKET (PRE-2014)
- DRECB02** CLUB CAR BRACKET (2015 & NEWER)
- DRECB11** YAMAHA BRACKET (2003-2008)
- DRECB05** YAMAHA BRACKET (2009 & NEWER)



*** EXPEDITED SHIPPING UPON REQUEST - WE HAVE ALL THE PARTS YOU NEED WHEN YOUR PICKER IS DOWN AND YOU NEED THEM RIGHT AWAY.**

Pricing is subject to change.

“CYCLONE” RANGE BALL WASHER



We call this ballwasher the Cyclone because it creates a circulating deep clean on the balls removing all dirt and debris from them.

- The best value ballwasher on the market
- Made in the USA out of heavy duty steel and a powerful drive motor.
- 1 Year Warranty
- Heavy duty nylon brush
- Debris removal
- Cleaning rate: 15,000 balls per hour
- Dimensions: 33" L x 19" W x 30.5" H
- Hopper capacity: 500 balls
- Water capacity: 8 gallons
- Electrical: 110 or 220 Volt
- Motor: 1/3 HP
- **Equipped with GFI outlets for safety**

DREBW01 110 VOLT CYCLONE

DREBW01-220 220 VOLT CYCLONE

“TORNADO” BALL WASHER

The same ballwasher as the Typhoon, but includes a lift system that will lift balls into a range dispenser. Save time and money from purchasing an elevator system or loading by hand!

- 1 Year Warranty
- Heavy duty nylon brush
- Unique steel spiral for debris removal
- Cleaning rate: 30,000 balls per hour
- Dimensions: 34" L x 23" W x 38" H
- Hopper capacity: 800 balls
- Water capacity: 14 gallons
- Electrical: 110 or 220 Volt
- Motor: 1/2 HP
- Equipped with GFI outlets for safety

DREBWTOR 110 VOLT TORNADO

DREBWTOR-220 220 VOLT TORNADO

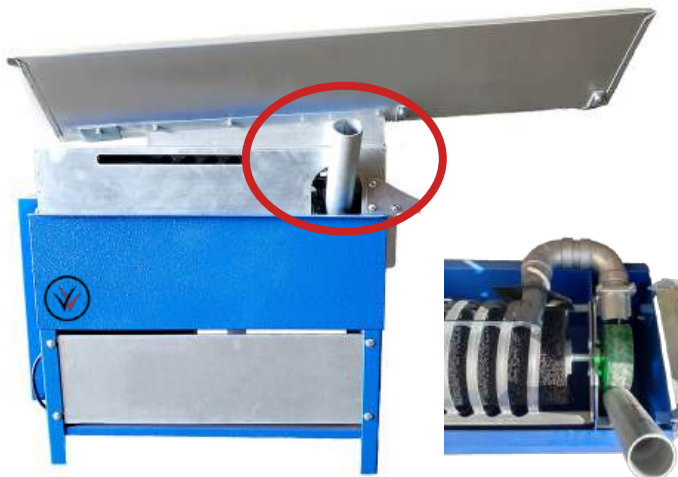

“TYPHOON” BALL WASHER



All of the same features as the cyclone, but a larger capacity model for bigger ranges.

- Made in the USA out of heavy duty steel and a powerful drive motor.
- 1 Year Warranty
- Heavy duty nylon brush
- Unique steel spiral for debris removal
- Cleaning rate: 30,000 balls per hour
- Dimensions: 34" L x 23" W x 38" H
- Hopper capacity: 800 balls
- Water capacity: 14 gallons
- Electrical: 110 or 220 Volt
- Motor: 1/2 HP
- Equipped with GFI outlets for safety

DREBW02 110 VOLT TYPHOON

DREBW02-220 220 VOLT TYPHOON



RANGE BALLWASHER REPAIR PARTS

We carry all of the parts you need to keep your ballwasher running smooth including rebuild kits when it is time for maintenance.

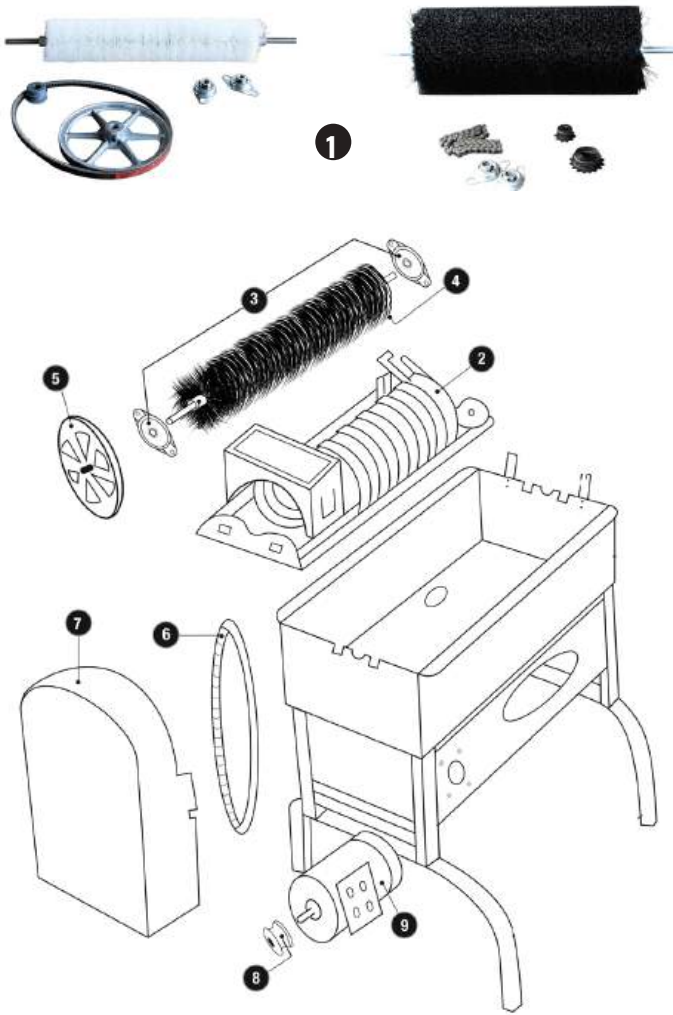

- | | | |
|---|-----------|--------------------------------|
| 1 | DREBW16 | REBUILD KIT - CYCLONE |
| 1 | DREBW18-T | REBUILD KIT - TYPHOON |
| 2 | DREBW10 | CYCLONE SPIRAL |
| 2 | DREBW13-T | TYPHOON SPIRAL |
| 3 | DREBW06 | BRUSH BEARING |
| 4 | DREBW07 | REPLACEMENT BRUSH - CYCLONE |
| 4 | DREBW07-T | REPLACEMENT BRUSH - TYPHOON |
| 5 | DREBW04 | LARGE PULLEY - CYCLONE |
| 5 | DREBW04-T | LARGE SPROCKET - TYPHOON |
| 6 | DREBW03 | DRIVE BELT - CYCLONE |
| 6 | DREBW03-T | DRIVE CHAIN - TYPHOON |
| 7 | DREBW15 | BELT GUARD - CYCLONE |
| 7 | DREBW14-T | CHAIN GUARD - TYPHOON |
| 8 | DREBW05 | SMALL PULLEY - CYCLONE |
| 8 | DREBW05-T | SMALL SPROCKET - TYPHOON |
| 9 | DREBW31 | 110 VOLT DRIVE MOTOR - CYCLONE |
| 9 | DREBW31-T | 110 VOLT DRIVE MOTOR - TYPHOON |

CASTER WHEEL KIT OR LEG EXTENSION KIT

Both the Cyclone and the Typhoon have optional leg extensions to make the ballwasher taller or caster kits to make it mobile. Taller units can dispense into a barrel.



- | | |
|---------|-------------------|
| DREBW18 | CASTER KIT |
| DREBW21 | LEG EXTENSION KIT |

Pricing is subject to change.

NITRO

NITRO PRACTICE RANGE BALL

NITRO range ball with 2-piece construction provides the necessary levels of performance that will make practicing more worthwhile.

- NITRO Premium White Tour Range Golf Ball
- Soft Feel
- Ultimate Range Experience
- 2-Piece Solid Core
- Durable Surlyn Cover
- Model # NRG300WB (White)
- Pack Size: 300 Balls / 25 Dozen

DRERBNP-WH NITRO 2-PIECE PRACTICE RANGE BALL, WHITE PER CASE (25 DOZEN)



NITRO LIMITED FLIGHT RANGE BALL

NITRO limited flight range ball is 20% limited in the distance, which is perfect for driving ranges that have real estate limitations.

- NITRO Premium Limited Flight Range Golf Ball
- Soft Feel
- Ultimate Range Experience
- 2-Piece Solid Core
- Durable Surlyn Cover
- Distance Limited
- Model # NRGLF300WB (White)
- Pack Size: 300 Balls / 25 Dozen

DRERBNL-WH NITRO 2-PIECE LIMITED FLIGHT RANGE BALL, WHITE PER CASE (25 DOZEN)



DRIVING RANGE BALLS

Premium Quality Balls for Every Range

- Best grade range ball on the market
- Premium tour ball-like feel, distance, and trajectory
- Consistent distance and trajectory, with no sacrifice to distance
- Stabilized inner core compound for smooth stroke feeling
- Unique Surlyn-blend coating gives incredible durability and fresh feel
- NIR drying system further improves durability & consistent ball surface
- Extremely durable (300 ID)
- Soft feel with 90 PGA Compression
- 392 aerodynamically optimized dimples

PREMIUM RANGE BALL

This Premium Range Ball is the #1 range ball on the market for cost-effectiveness.

Highest durability. Smooth feel. Sleek 3 stripe design. Perfect for your driving range.

LIMITED FLIGHT RANGE BALL

The 2 piece premium limited flight top range ball is made to meet the standards of driving ranges with short landing areas (below 250 yards).

With lower trajectory and distance potential (90-95% limited compared to premium top range ball), these balls are limited from going over the fence/net. Still the same highest durability, smooth stroke feeling, and the sleek design. Ideal for driving ranges with short landing areas.

DRERBPR-WH PREMIUM RANGE BALL, WHITE PER CASE (25 DOZEN)

DRERBPR-YW PREMIUM RANGE BALL, YELLOW PER CASE (25 DOZEN)

DRERBLTD-WH LIMITED FLIGHT RANGE BALL, WHITE PER CASE (25 DOZEN)

DRERBLTD-YW LIMITED FLIGHT RANGE BALL, YELLOW PER CASE (25 DOZEN)

DRERBFL-WH FLOATER RANGE BALL, WHITE PER CASE (25 DOZEN)



FLOATER RANGE BALL

The 2 Piece Premium Floater Ball is the #1 Floater ball in the market engineered to float with TOP RANGE BALL characteristics.

40 DRIVING RANGE & PRACTICE AREA

ORIGINAL BAG SHAG

Enclosed w/ Zipper - Customized Logo Option Available



- DREBS-RD RED
- DREBS-BK BLACK
- DREBS-GR GREEN
- DREBS-BL BLUE

RANGER BAG SHAG

Open Top



- DRERBS-RD RED
- DRERBS-BK BLACK
- DRERBS-GR GREEN

SHAG TUBE

Aluminum Tubes



DREST
HOLDS 23 BALLS

STACKABLE RANGE BAGS



- DRERBC25 25 BALL BAG
- DRERBC40 40 BALL BAG
- DRERBC60 60 BALL BAG
- DRERBC85 85 BALL BAG

AVAILABLE IN RED, BLACK OR GREEN

COTTON RANGE BAGS

Customized Logo Option Available



- DRERBCT25 25 BALL BAG
- DRERBCT40 40 BALL BAG
- DRERBCT60 60 BALL BAG
- DRERBCT85 85 BALL BAG

AVAILABLE IN RED, BLACK, OR GREEN

MESH RANGE BAGS



- DRERBM25 25 BALL BAG
- DRERBM35 35 BALL BAG
- DRERBM50 50 BALL BAG
- DRERBM95 95 BALL BAG

AVAILABLE IN BLUE, GREEN, GOLD OR BLACK

ROLLING GOLF BALL PICKER W/ RETRACTABLE HANDLE

PAR WEST EXCLUSIVE



- Will not fall apart like other versions
- Handle is screw on - no glue required & easy assembly
- 48" handle rotates to users of any height
- Comes apart for easy storage
- Green & White color scheme

PWRBP

THE CHIP N SWEEP

Range Ball Sweeper

PAR WEST EXCLUSIVE



- Will not fall apart like other versions
- Handle is screw on - no glue required & easy assembly
- 48" handle rotates to users of any height
- Comes apart for easy storage
- Green & White color scheme

DREBP

WALK BEHIND BALL PICKER

Single Unit



- Great unit for chipping or putting Greens
- 19" wide
- 300 ball capacity
- Premium materials make it corrosion resistant

DRESP01

WALK BEHIND BALL PICKER

Double Unit



- Great unit for chipping or putting Greens
- 39.5" wide
- 600 ball capacity
- Premium materials make it corrosion resistant

DRESP02

Pricing is subject to change.

COLOR OPTION KEY



GREEN BROWN BLACK WALNUT GREY

All crates can be customized with logo or plain.
Call us for more color & logo options.

LOGO OPTION KEY



LEXAN



ENGRAVED



CAST BRONZE



CAST ALUMINUM

PREMIUM RANGE CRATE DISPENSERS

150 RANGE CRATE DISPENSER

Stores 150 Range Balls



- GCA150-GN GREEN
- GCA150-BK BLACK
- GCA150-BR BROWN

250 RANGE CRATE DISPENSER

Stores 250 Range Balls



- GCA250-GN GREEN
- GCA250-BK BLACK
- GCA250-BR BROWN
- GCA200-CG COASTAL GREY

350 RANGE CRATE DISPENSER

Stores 350 Range Balls



- GCA300-GN GREEN
- GCA300-BK BLACK
- GCA300-BR BROWN
- GCA300-CG COASTAL GREY

300 RANGE CRATE DISPENSER

Stores 300 Range Balls



- PAR3440 GREEN
 - PAR3441 BLACK
 - PAR3442 REDWOOD
- Comes with steel trap door on the side

RANGE BASKETS

Black, Green Or Yellow



- DRERB25_ 25 BALL BASKET
- DRERB40_ 40 BALL BASKET
- DRERB70_ 70 BALL BASKET
- DRERB100_ 100 BALL BASKET
- DRERB200_ 200 BALL BASKET

_ = Enter Color Option In Final Spot (Yellow=YW, Black=BK, Green =GR)

BALL CRATES

Black Or Green



LARGE CRATES

19" x 33" x 11"

- DREBCLB LARGE BLACK
- DREBCLG LARGE GREEN

SMALL CRATES

13" x 13" x 11"

- DREBCSB SMALL BLACK
- DREBCSG SMALL GREEN

RANGE BALL STORAGE BOX

Stores Up to 5000 Golf Balls



- Lockable (lock sold separately)
- 39" wide x 28" deep x 27" tall

- PAR3350 HUNTER GREEN
- PAR3351 BLACK
- PAR3352 REDWOOD

RANGE BALL TRAYS



- DREBT-G ARMY GREEN TRAY
- DREBT-B BLACK TRAY

RUBBER TEES

- DRERT175 1.75"
- DRERT200 2"
- DRERT225 2.25"
- DRERT250 2.5"
- DRERT275 2.75"
- DRERT300 3"
- DRERT325 3.25"



42 DRIVING RANGE & PRACTICE AREA

ORIGINAL PYRAMID STACKER™ & TRAYS

- An industry favorite - simply pour balls into the stacker and leave a perfect pyramid on the tray
- Leaves a clean look for staged range balls
- Made of galvanized steel
- Use metal or plastic trays below

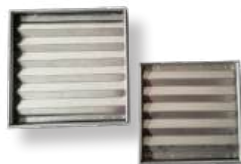

PYRAMID STACKERS

| | |
|-----------------|-----------|
| DREMP55 | 55 BALLS |
| DREMP91 | 91 BALLS |
| DREMP140 | 140 BALLS |
| DREMP204 | 204 BALLS |
| DREMP285 | 285 BALLS |

METAL STACKING TRAYS

| | |
|-----------------|-----------|
| DREMT55 | 55 BALLS |
| DREMT91 | 91 BALLS |
| DREMT140 | 140 BALLS |
| DREMT204 | 204 BALLS |
| DREMT285 | 285 BALLS |

PLASTIC STACKING TRAYS

| | |
|-----------------|-----------|
| DREPT55 | 55 BALLS |
| DREPT91 | 91 BALLS |
| DREPT140 | 140 BALLS |
| DREPT204 | 204 BALLS |

CUSTOM GOLF TEES

- Premium custom golf tees that keep your logo in players' hands from the first tee to the last green.
- 3 popular lengths available: 2 1/8", 2 3/4", 3 1/4".
- Print where it matters: choose Shank Only, Cup & Shank, or Cup Only imprint options.
- Perfect for tournaments, outings, pro shops, member gifts, and sponsor packs (great add-on for tee gifts and swag bags).



| PART # | SIZE | QTY | SHANK ONLY | QTY | CUP & SHANK | CUP ONLY |
|------------------|--------|---------|------------|---------|-------------|----------|
| DRECGT218 | 2 1/8" | 1K-9K | | 1K-9K | | |
| | 2 1/8" | 10K-49K | | 10K-49K | | |
| | 2 1/8" | 50K-99K | | 50K+ | | |
| | 2 1/8" | 100K | | -- | -- | -- |
| DRECGT234 | 2 3/4" | 1K-9K | | 1K-9K | | |
| | 2 3/4" | 10K-49K | | 10K-49K | | |
| | 2 3/4" | 50K-99K | | 50K-99K | | |
| | 2 3/4" | 100K | | -- | -- | -- |
| DRECGT314 | 3 1/4" | 1K-9K | | 1K-9K | | |
| | 3 1/4" | 10K-49K | | 10K-49K | | |
| | 3 1/4" | 50K-99K | | 50K-99K | | |
| | 3 1/4" | 100K | | -- | -- | -- |

PRE PACKAGED GOLF TEES

- Made from all natural bamboo.
- Available in natural, white or assorted mix
- Case of 10,000 bulk tees
- Bags of 50 tees
- 200 bags per box

| | | |
|---------------------|--------|---------|
| DREABT218-NA | 2 1/8" | NATURAL |
| DREABT218-WH | 2 1/8" | WHITE |
| DREABT234-NA | 2 3/4" | NATURAL |
| DREABT234-WH | 2 3/4" | WHITE |
| DREABT314-NA | 3 1/4" | NATURAL |
| DREABT314-WH | 3 1/4" | WHITE |

BAGS OF 50 TEES, 200 BAGS PER BOX

BULK GOLF TEES

- Made from all natural bamboo.
- Available in natural, white or assorted mix
- Case of 10,000 bulk tees

| | | |
|---------------------|--------|---------|
| DREBAM218-NA | 2 1/8" | NATURAL |
| DREBAM218-WH | 2 1/8" | WHITE |
| DREBAM234-NA | 2 3/4" | NATURAL |
| DREBAM234-WH | 2 3/4" | WHITE |
| DREBAM314-NA | 3 1/4" | NATURAL |
| DREBAM314-WH | 3 1/4" | WHITE |

CASE OF 10,000 TEES

WOODEN TEE HOLDERS

| | |
|------------------|---------------|
| DRERTW100 | 1" RUBBER TEE |
| DRERTW200 | 2" RUBBER TEE |

Pricing is subject to change.

PERMA CORE LAMINATE RANGE DIVIDERS

Choose Plain, Logo Or Divot Pattern Designs



- 44" long x 4" high x 1/2" thick
- Includes stainless steel spikes
- Divot pattern design shows golfers how to maximize range space and is double sided
- Logo style is a double sided design
- Available in all 11 of our perma core colors detailed in our sign sections

- PWPCTD-DIV_-** DIVOT PATTERN DESIGN
- PWPCTD-LOG_-** CUSTOM LOGO DESIGN
- PWPCTD-PL_-** PLAIN

RANGE DIVIDER COLOR OPTION KEY



Double Spike Divider Ideal for Grass



Foot Pad Divider Ideal for Hard Surfaces

COLOR OPTION KEY



LOGO OPTION KEY



All Range Dividers can be customized with or without logo and with foot pads or flat with spikes. Call Us For More Color options as colors can be combined for two-tone look.



DELUXE ARCHED RANGE DIVIDER
40" x 12" x 2'
12 Color Options

- RCPRD-DA-GN** GREEN
- RCPRD-DA--BK** BLACK
- RCPRD-DA--BR** BROWN



TRADITIONAL RANGE DIVIDER
48" x 4" x 2"

- RCPRD-AR-GN** GREEN
- RCPRD-AR-BK** BLACK
- RCPRD-AR-BR** BROWN



TRIBUTE RANGE DIVIDER
48" x 4" x 2"

- RCPRD-TR-GN** GREEN
- RCPRD-TR-BK** BLACK
- RCPRD-TR-BR** BROWN



RECYCLED LUMBER TEE DIVIDERS
48" x 4" x 2"

- RCPRD-US-GN** GREEN UPRIGHT STYLE
- RCPRD-US-BK** BLACK UPRIGHT STYLE
- RCPRD-US-BR** BROWN UPRIGHT STYLE
- RCPRD-FS-GN** GREEN FLAT STYLE
- RCPRD-FS-BK** BLACK FLAT STYLE
- RCPRD-FS-BR** BROWN FLAT STYLE

Includes stainless steel spikes



METAL TEE DIVIDERS
31" x 61" x 9"

- DRETD01GN** GREEN
- DRETD01BK** BLACK

Divider has sturdy feet with bolt holes to safely anchor to your driving range surface.

PARWEST.COM | 714-893-1555

RANGE ALIGNMENT ROPE

100 Feet Long



- 10 foot spacing markers to evenly space range dividers
- Winds back up on spool when done

STD36700



PAR WEST

COLOR OPTION KEY



GREEN BROWN BLACK WALNUT GREY

LOGO OPTION KEY



LEXAN



ENGRAVED



CAST BRONZE



CAST ALUMINUM



SINGLE POST BAG STAND
Single Post w/ Three Spikes
14" L x 16" W x 36" H

RCPBS-SP-GN GREEN
RCPBS-SP-BK BLACK
RCPBS-SP-BR BROWN



TRADITIONAL BAG STAND
21" L x 16" W x 28" H

RCPBS01-GN GREEN
RCPBS01-BK BLACK
RCPBS01-BR BROWN



**TRADITIONAL BAG STAND
W/ CUP HOLDER**
19" L x 21" W x 28" H

RCPBS02-GN GREEN
RCPBS02-BK BLACK
RCPBS02-BR BROWN



CENTURY BAG STAND
W/Cup Holder & Logo Plate
19" L x 21" W x 28" H

RCPBS-CFL-GN GREEN
RCPBS-CFL-BK BLACK
RCPBS-CFL-BR BROWN



CALL US
TODAY FOR
YOUR CUSTOM
BAG STAND
SOLUTION!

All bag stands can be customized with or without logo and no cup holders, one cup holder, two cup holders, and club notches. Bag racks can be customized with 5 to 8 bag stalls and logo for each style.

Call us for more color options as colors can be combined for two-tone look.





MONSTER MAT GOLF MAT

1.25" Nylon Turf Height

Transform your golf game with the Monster Mat Golf Mat – the gold standard for home simulators, driving ranges, and country clubs. Crafted in the U.S.A.

- 1 1/8" Z-Pro Fiber hitting the surface
- Includes (2) tee holders - one tee hole on each side of the mat. 4 total holes

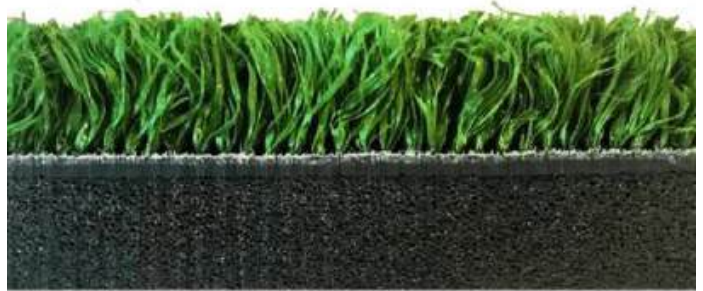

DRERMMM 5FT X 5FT

DRERMMM-20 5FT X 20FT

Volume Discounts Available on Mat Orders of 10 Or More



TEE LINE TURF MAT

The Only Mat That Holds Wooden Tee

- Holds a wooden tee anywhere on the mat
- reduced "bounce effect" you get from other mats
- Also has 8 drilled holes for rubber tees
- 100% nylon fiber will not leave Green marks on clubs
- Made in the USA - water and mold resistant
- 60" x 60" square
- 5/8" closed cell shock resistant foam pad



DRERMTLP SQUARE TEE LINE MAT



DUO TURF MAT 3/4" Nylon Turf Height

- 100% premium nylon tufted turf (straight and curled)
- Same fiber design and quality as our ultra mat, but a short turf height makes this a great value mat
- Allows better hitting experience and stable stance
- Excellent wear-and-tear and heat resistance
- cushion foam pad provides excellent shock absorption without any curling
- 8 tee holes for proper rotation



DRERMDT DUO TURF MAT

Volume Discounts Available On Mat Orders Of 10 Or More



CLASSIC FAIRWAY MAT Classic Nylon Turf

- Keeping the fresh look for years with healthy curled turf
- 100% premium nylon tufted turf (curled)
- Excellent wear-and-tear and heat resistance
- Advanced shock absorption and maximum protection
- 8 tee holes.
- Dimensions: 60 in x 60 in



DRERMFV CLASSIC MAT

Pricing is subject to change.

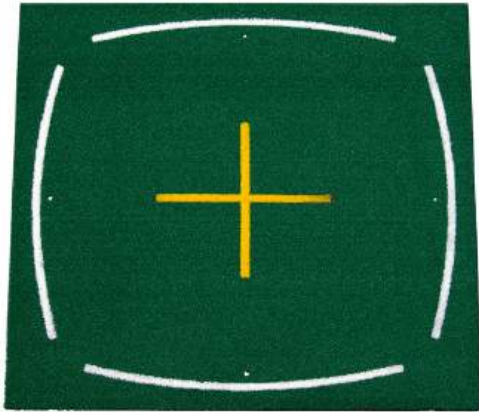

PRO TEACHING LINE MAT

3/4" Nylon Turf

- Designed for teaching pros & golf lessons at driving ranges
- 100% premium nylon tufted turf (curled), colorized yarns embedded onto the mat (does not fall out)
- Visible swing path and stance area
- cushion foam pad provides shock absorption and maximum protection
- 4 tee holes.
- Dimensions: 60 in x 60 in



DRERMTM LINE MAT

MAT REPLACEMENT INSERTS

Fits Fiberbuilt And Most "Mat Systems"

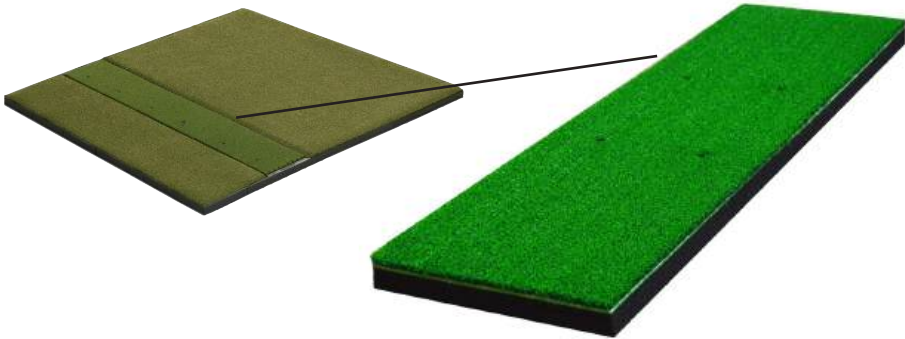

HITTING AREA INSERT

- Fits most standard frames
- Premium nylon turf
- 4 tee holes
- 4 feet long x 1 foot wide

DRERMHI

STANCE AREA INSERT

- Fits most standard frames
- Premium nylon turf
- Comfortable and realistic feel
- 4 feet long x 4 feet wide

DRERMMSM



48 DRIVING RANGE & PRACTICE AREA

PERMA CORE CHIPPING YARDAGE TARGETS

Easy to Read Set of 9 Yardages from 20-100 Yards
15" W x 9" H

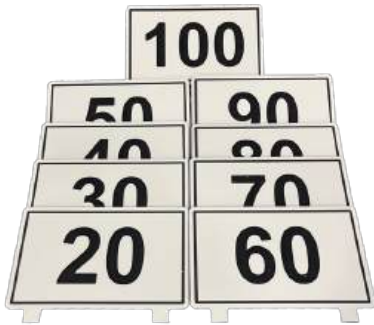

Custom Number Options Available!

- PWPC-CT-1 GREEN WITH WHITE NUMBERS
- PWPC-CT-2 WHITE WITH GREEN NUMBERS
- PWPC-CT-3 BLACK WITH WHITE NUMBERS
- PWPC-CT-4 WHITE WITH BLACK NUMBERS
- PWPC-CT-5 RED WITH WHITE NUMBERS
- PWPC-CT-6 WHITE WITH RED NUMBERS
- PWPC-CT-7 BLUE WITH WHITE NUMBERS
- PWPC-CT-8 BROWN WITH WHITE NUMBERS
- PWPC-CT-9 YELLOW WITH BLACK NUMBERS
- PWPC-CT-10 TAN WITH GREEN NUMBERS
- PWPC-CT-11 TAN WITH BROWN NUMBERS
- PWPC-CT-12 BROWN WITH TAN NUMBERS

RANGE TARGET NET

4 Foot Diameter



- Pads come in three colors - yellow, white, blue, and red
- Pads sold separately

- DRERTN-4-WH TARGET NET W/WHITE PADS
- DRERTN-4-RD TARGET NET W/RED PADS
- DRERTN-4-YW TARGET NET W/YELLOW PADS
- DRERTN-4-BL TARGET NET W/BLUE PADS

THE BULLSEYE

Premium Pitching & Chipping Targets

- 36" tall x 26" wide
- Made of the highest quality materials and designed to last
- Shipped with optional foam padding kit to give unit extra protection from impact of hard hit golf balls
- Easy to assemble - takes less than 2 minutes to assemble
- Bright colors make them highly visible from any distance
- Base can be filled with water to weigh it down in the wind
- Design turns chipping into a fun game
- No net means you can easily clean up balls in and around it



- DRETG-3Y YELLOW
- DRETG-3R RED
- DRETG-3G GREEN
- DRETG-3B BLUE



GOLF HITTING POWER CAGE & TARGET

10ft. High x 10ft. Wide x 10ft. Deep



- Includes net and target
- Mat sold separately

DREHC-10

Need mats for your power cage? See page for mat options!



Pricing is subject to change.

PREMIUM RANGE POLES

COMPLETE RANGE POLE KITS

Includes Ground Anchor, Flag, Flagstick



Our Premium Range Poles Are The Best Here's Why:

- Made with the thickest 4" pipe on the market for a longer life that stands up to the toughest use
- We ship our poles in two pieces so you save a ton in shipping costs
- Our flags are the highest quality 400 Denier oversized range flags (18" x 25")
- Our complete kit is the best value on the market
- We stock the colors below, but can make custom colors also



COMPLETE RANGE POLE KITS

No Flags - Poles and Anchors Only

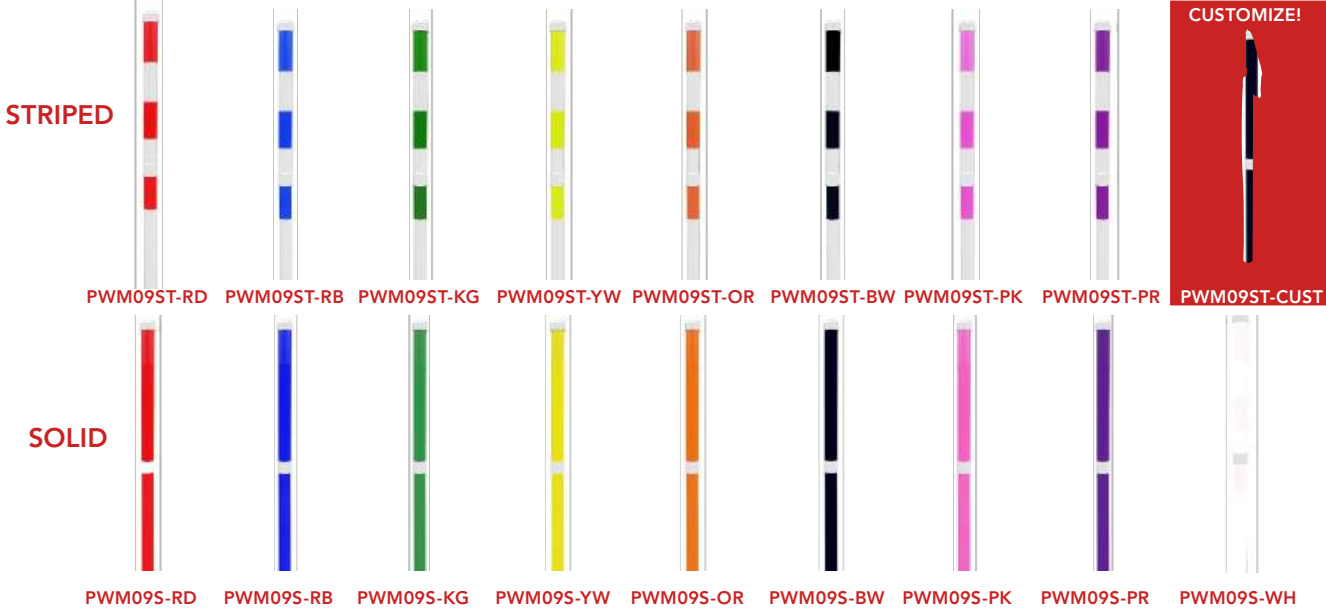

OVERSIZED RANGE POLE FLAGS

18 x 25 Solid or Checkered

- Constructed of 400 denier premium nylon
- 1/2" one-piece border with zig-zag stitch
- Bar-tac reinforced corners
- Available with tube, soft tube or grommet



SOLID - | CHECKERED -



50 DRIVING RANGE & PRACTICE AREA



Sign posts sold separately. Visit sign post section on page 26 for more options.

VERTICAL YARDAGE TARGETS

12" W x 48" T

| | |
|--------------|------------|
| PWPCYV-50-1 | GREEN 50 |
| PWPCYV-75-2 | WHITE 75 |
| PWPCYV-100-5 | RED 100 |
| PWPCYV-150-3 | BLACK 150 |
| PWPCYV-200-4 | BLUE 200 |
| PWPCYV-250-8 | YELLOW 250 |



HORIZONTAL YARDAGE TARGETS

31" W x 24" T



Sign posts sold separately. Visit sign post section on page 26 for more options.

| | |
|--------------|------------|
| PWPCYH-50-1 | GREEN 50 |
| PWPCYH-75-2 | WHITE 75 |
| PWPCYH-100-5 | RED 100 |
| PWPCYH-150-3 | BLACK 150 |
| PWPCYH-200-4 | BLUE 200 |
| PWPCYH-250-8 | YELLOW 250 |



ARCH YARDAGE TARGETS

36" W x 20" T



Sign posts sold separately. Visit sign post section on page 26 for more options.

| | |
|--------------|------------|
| PWPCYA-50-1 | GREEN 50 |
| PWPCYA75-2 | WHITE 75 |
| PWPCYA-100-5 | RED 100 |
| PWPCYA-150-3 | BLACK 150 |
| PWPCYA-200-4 | BLUE 200 |
| PWPCYA-250-8 | YELLOW 250 |



OVAL YARDAGE TARGETS

47" W x 30" T



Two 4" X 4" 6 feet sign posts included

| | |
|--------------|------------|
| PWPCYO-50-1 | GREEN 50 |
| PWPCYO-75-2 | WHITE 75 |
| PWPCYO-100-5 | RED 100 |
| PWPCYO-150-3 | BLACK 150 |
| PWPCYO-200-4 | BLUE 200 |
| PWPCYO-250-8 | YELLOW 250 |



YARDAGE POST OPTIONS

RECYCLED PLASTIC MOUNTING POST OPTIONS

5, 6, 7, Or 8 Feet Options

| | |
|-------------|---------|
| RCPOST4460- | 5' POST |
| RCPOST4472- | 6' POST |
| RCPOST4484- | 7' POST |
| RCPOST4496- | 8' POST |

- Black, White, Brown, and Green
- 4 inch x 4 inch material
- Great for yardage posts

8 FT U-CHANNEL SIGN POST

- Green baked enamel u-channel posts resist corrosion.
- Tapered end easily drives into the ground.
- 3/8" Holes on 1" centers to easily attach signs.
- Meets mutcd standards.
- Pair with custom aluminum course signs. Sold separately.

PWPOSTUCG-8



Pricing is subject to change.



CIRCLE YARDAGE TARGETS

24" Diameter

- PWPCYC-50-1 GREEN 50
- PWPCYC-75-2 WHITE 75
- PWPCYC-100-5 RED 100
- PWPCYC-150-3 BLACK 150
- PWPCYC-200-4 BLUE 200
- PWPCYC-250-8 YELLOW 250

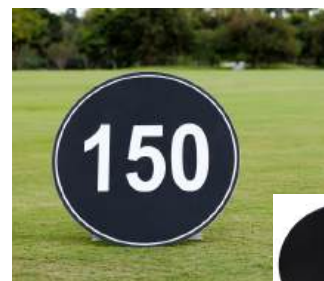

Targets include target stand (see pictured) and two spikes



BULLSEYE YARDAGE TARGETS

24" Diameter

- PWPCYB-50-1 GREEN 50
- PWPCYB-75-2 WHITE 75
- PWPCYB-100-5 RED 100
- PWPCYB-150-3 BLACK 150
- PWPCYB-200-4 BLUE 200
- PWPCYB-250-8 YELLOW 250

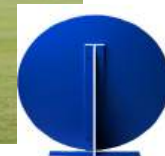

Targets include target stand (see pictured) and two spikes

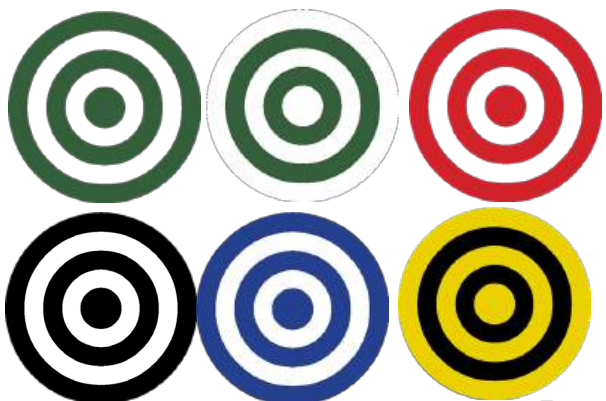

BULLSEYE TARGETS

24" Diameter

- PWPCBT-50-1 GREEN/WHITE
- PWPCBT-75-2 WHITE/GREEN
- PWPCBT-100-5 RED/WHITE
- PWPCBT-150-3 BLACK/WHITE
- PWPCBT-200-4 BLUE/WHITE
- PWPCBT-250-8 YELLOW/BLACK



Targets include target stand (see pictured) and two spikes



CUSTOM TARGETS

24" Diameter

- PWPCCT-50-1 GREEN/WHITE
- PWPCCT-75-2 WHITE/GREEN
- PWPCCT-100-5 RED/WHITE
- PWPCCT-150-3 BLACK/WHITE
- PWPCCT-200-4 BLUE/WHITE
- PWPCCT-250-8 YELLOW/BLACK



Targets include target stand (see pictured) and two spikes



YARDAGE EASELS

Made of our premium Perma-core 1/2 inch thick material. Use the color chart on the left for available options. Flag colors and custom logos are also available to add.

EASEL COLOR OPTION KEY



LARGE DELUXE YARDAGE EASELS

32" X 22" - Single Or Double Sided

- PWPCYE-COLOR-SS-4 SINGLE SIDED - 4 YARDAGE
- PWPCYE-COLOR-SS-5 SINGLE SIDED - 5 YARDAGE
- PWPCYE-COLOR-SS-6 SINGLE SIDED - 6 YARDAGE
- PWPCYE-COLOR-SS-7 SINGLE SIDED - 7 YARDAGE
- PWPCYE-COLOR-DS-4 DOUBLE SIDED - 4 YARDAGE
- PWPCYE-COLOR-DS-5 DOUBLE SIDED - 5 YARDAGE
- PWPCYE-COLOR-DS-6 DOUBLE SIDED - 6 YARDAGE
- PWPCYE-COLOR-DS-7 DOUBLE SIDED - 7 YARDAGE



SMALL ECONOMY YARDAGE EASELS

16" X 24" - Single Or Double Sided

- PWPCEYE-COLOR-SS-4 SINGLE SIDED - 4 YARDAGE
- PWPCEYE-COLOR-DS-4 DOUBLE SIDED - 4 YARDAGE

YARDAGE EASEL NUMBERS

Replacement Slider Numbers



- Sold in a set of 50 Numbers broken down in the following quantities:
 Qty 8 each of #'s 0,5
 Qty 6 each of # 1
 Qty 4 each of #'s 2,3,4,6,7,8,9

- Aluminum is white and numbers are Black
- 3 in Dimensions – 3 inches tall x 2.25 inches wide



CLOCK EASEL WITH YARDAGES

40" X 32" - Single Or Double Sided

- PWPCEY-COLOR-SS SINGLE SIDED - 6 YARDAGE
- PWPCEY-COLOR-DS DOUBLE SIDED - 6 YARDAGE

GCASN3 3 IN TALL

CUSTOMIZE YOUR OWN RANGE EASEL!



LOOKING FOR A PERSONALIZED EASEL?

We'll Customize Any of Our easels with your logo. Reach Out to Us for a Proof Within 1 Business Day At no Charge!



Pricing is subject to change.

COLOR OPTION KEY



GREEN BROWN BLACK WALNUT GREY

Call us for more color & logo options. Colors can be combined for two-tone look.

LOGO OPTION KEY



LEXAN ENGRAVED CAST BRONZE CAST ALUMINUM

RECYCLED SQUARE CLUB WASHER

W/ Internal Brushes



- Attractive and maintenance-free housing for cleaning clubs
- Includes durable brushes that are gentle on clubs while offering quick and efficient cleaning.
- Choose green, brown, black or two tone color options

- RCPCW03-GN** HUNTER GREEN
- RCPCW03-BR** BROWN
- RCPCW03-BK** BLACK
- RCPCW03-BB** BLACK W/ BROWN TRIM
- RCPCW03-GB** GREEN WITH BLACK TRIM

RECYCLED ROUND CLUB WASHER

W/ Internal Brushes



- Attractive and maintenance-free housing for cleaning clubs
- Includes durable brushes that are gentle on clubs while offering quick and efficient cleaning.
- Choose green, brown or black

- RCPCW01-GN** HUNTER GREEN
- RCPCW01-BR** BROWN
- RCPCW01-BK** BLACK

RANGE MATE

Club Washer



- 9 gallon, fade resistant polyethylene container
- When ordering replacement brushes, unit requires two

- STD01650** GREEN GRANITE
- STD01602** SINGLE BRUSH

PAR AIDE CLUB WASHER

Mounting Accessories



- PAR250-02** GREEN CLUB WASHER
- PAR250-00** BLACK CLUB WASHER
- PAR260** MOUNTING SPIKE
- PAR275** PIPE OR WALL MOUNT BRACKET
- PAR254** REPLACEMENT BRUSHES (2)

RANGE PRO

Club Washer



- Water bucket with hand brush included
- Convenient towel bar and hooks for various placement option

- PAR3310** GREEN
- PAR3315** BLACK
- PAR3316** REDWOOD

54 DRIVING RANGE & PRACTICE AREA



PREMIUM PRACTICE GREEN FLAGSTICKS



3/4" TAPERED FLAGSTICK

- 1/2" Fiberglass pole or tournament tapered 3/4"
- 30" Tall
- Available in solid or striped colors
- Durable metal base
- Includes top knob
- Custom sizes & colors available

Solid colors - white, yellow black or pink

Striped colors - white/black, white/red, white/blue or yellow/black



PWPGS-__ WHITE OR YELLOW SOLID

PWPGSS-__ STRIPED/OTHER SOLID

PWPGST-__ TAPERED SOLID COLOR

PWPGSST-__ TAPERED STRIPED

PREMIUM CUPLESS PRACTICE GREEN FLAGSTICKS

- 1/2" Fiberglass pole or tournament tapered 3/4"
- 30" Tall
- Available in solid or striped colors
- Durable metal spike
- Includes top knob
- Custom sizes & colors available



Solid Colors - White, Yellow

Striped Colors - Red/White, Black/White, Blue/White Or Green/White



PWPGSC-__ WHITE OR YELLOW SOLID

PWPGSSC-__ STRIPED/OTHER SOLID

IPE HARDWOOD PRACTICE GREEN FLAGSTICKS

- Unmatched strength
- Natural resistance- ipe's natural properties ensure your investment lasts for years to come.
- Superior construction
- Practical design
- Long-lasting finish
- Ipe hardwood poles come with a bronze base and either have a flag or our custom bronze top with an etched logo.
- Choose either a black aluminum or brass fittings.

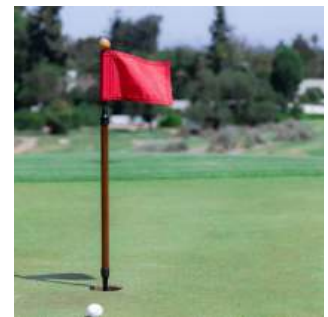

PWPGW FLAGSTICK W/ BLACK FITTING

PWPGW-B FLAGSTICK W/ BRASS FITTING

PC-PGH-35-AL BRONZE 3" HEAD ONLY

LIGHTED PRACTICE GREEN STICKS

Rechargeable Battery Operated

- One charger will do up to five sticks
- 1/2" Acrylic pole - 30" tall
- Run time of about 2 hours
- Charger Sold Separately

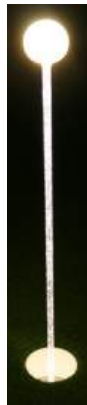

GCAGBT3500 WHITE COLOR STICK

GCAGBT3000 CHARGING UNIT

PRACTICE GREEN POLE KNOBS



PWTKR ROUND KNOB

PWTKT T HANDLE KNOB

PAR9099-9 BALL KNOB (PACK OF 9)

Pricing is subject to change.

PERMA CORE NUMBERED PRACTICE GREEN POLE TOPS

Circle & Flag Options

- CIRCLE TOP- 4" circle diameter with raised numbers in center
- FLAG TOP - 6" by 3.5" with raised numbers in center
- No fading or paint chipping - these last forever
- Add number you want to end of part number
- 3/4 inch thick - USA made laminate plastic with tapped threads
- All heads can also compatible with IPE Hardwood Practice Green

PWPCPGND-1- CIRCLE POLE TOP

PWPCPGFND- FLAG POLE TOP

*See page 54 for more practice stick options.

PERMA CORE LOGO DECAL PRACTICE GREEN POLE TOPS

Circle & Flag Options

- CIRCLE TOP- 4" circle diameter with logo decal
- FLAG TOP - 6" by 3.5" with logo decal
- No fading or paint chipping - these last forever
- 3/4 inch thick - USA made laminate plastic with tapped threads
- All heads can also compatible with IPE Hardwood Practice Green Flagsticks

PWPCGLD-1 DECAL CIRCLE POLE TOP

PWPCPGGLD-1 DECAL FLAG POLE TOP

*See page 54 for more practice stick options.

POLE TOP COLOR OPTION KEY

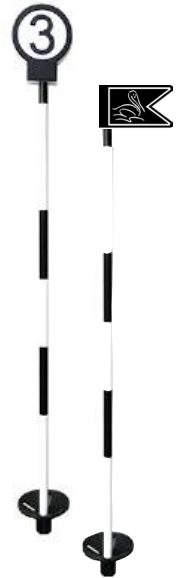

PRACTICE GREEN MARKERS

Numbered



Flags not included

- Create numbered holes on the practice green
- Includes 3/8" rod, metal base, aluminum top and number decal
- Vinyl decals are weatherproof
- Double-sided
- Same color options as the logo markers
- Numbers can be black, red, white, yellow, green or blue

PWPGN



PRACTICE GREEN MARKERS

Personalized With Logo

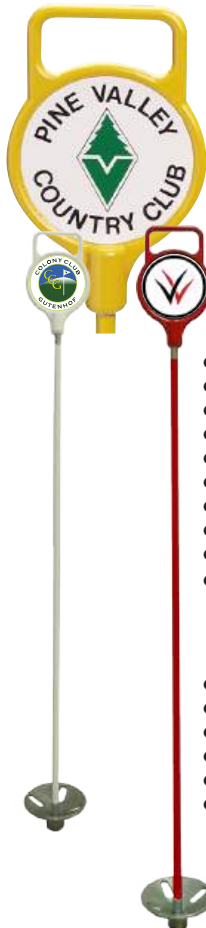

- Brand your practice green markers with your logo
- Includes 3/8" rod, metal base, Aluminum top and logo decal
- Vinyl decals are weatherproof
- Double sided logo
- No art set up fees for logo

ROD COLOR OPTIONS

- White
- Red
- Black
- Yellow
- Blue
- Green
- Black/White striped - add \$3.00
- White/Red striped - add \$3.00
- Yellow/Black striped - add \$3.00
- Green/white striped - add \$3.00

TOP COLOR OPTIONS

- White
- Yellow
- Red
- Green
- Blue
- Black

PWPGL

WOOD GRAIN CAST ALUMINUM MARKER

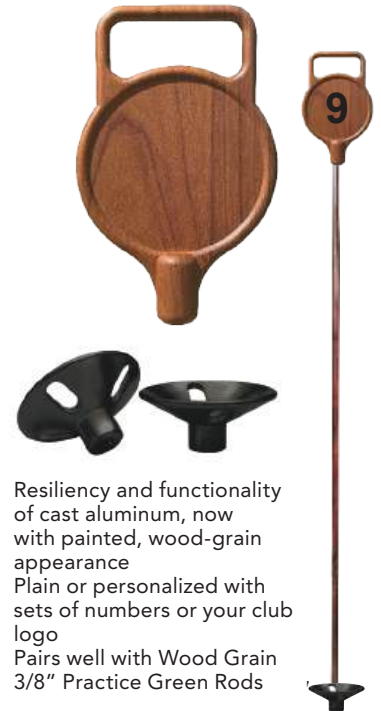

- Resiliency and functionality of cast aluminum, now with painted, wood-grain appearance
- Plain or personalized with sets of numbers or your club logo
- Pairs well with Wood Grain 3/8" Practice Green Rods

STD20531 HEAD ONLY

STD20523 BLACK METAL BASE



TOURNAMENT PRACTICE GREEN FLAGSTICKS



- PAR9110 WHITE
- PAR9111 YELLOW
- PAR9112 RED/WHITE
- PAR9113 BLACK/WHITE
- PAR9114 GREEN/WHITE
- PAR9115 BLACK/YELLOW

1/2 INCH PRACTICE GREEN FLAGSTICKS



- PAR9190 WHITE
- PAR9191 YELLOW
- PAR9192 RED/WHITE
- PAR9193 BLACK/WHITE
- PAR9194 GREEN/WHITE
- PAR9195 BLACK/YELLOW

WOODEN PRACTICE GREEN FLAGSTICKS



Flags not included

- PAR9121 BASE W/ TOP KNOB
- PAR9121-2 CUPLESS W/ TOP KNOB
- PAR9120 REGULAR TOP
- PAR9120-2 CUPLESS W/ REGULAR TOP
- PAR9098-9 WOODEN KNOB (PACK OF 9)

4" ALUMINUM PRACTICE GREEN CUP



STD18150



4" PLASTIC PRACTICE GREEN CUPS



STD18100



PAR940



PUSH N' PUTT PRACTICE GREEN FLAGSTICK



PUSH DOWN ON FLAG KNOB TO EJECT BALLS FROM CUP



- Reduces bending over to retrieve golf balls that fall back into the cup
- Ideal for golf pros teaching putting skills or lessons

Flags are not included and are sold separately.

PWPGS-PD

SURE PUTT PRACTICE SYSTEM



- Widely regarded as the finest putting aid for any level of golfer
- Putting to the smaller cup, 3 in. diameter compared to a regulation cup helps focus aim
- System comes with 3 cups, cup cutter and sign

PAR10710 SURE PUTT SYSTEM

PAR10702 METAL 2" CUPS

STANDARD GOLF HOLE REDUCER



- Sits on top of a recessed cup to be flush with the green
- Reduced cup opening by 1" (2.5 cm)
- Helps players fine-tune putting skills
- Ideal for practice greens, or coaches / instructors to place on the course greens for advanced player practice
- Made from a synthetic polymer for a lighter and more durable construction

STD18010

Pricing is subject to change.

SOLID COLOR FLAGS



PW6X8PL

CHECKERED FLAGS



PW6X8CK

DIAGONAL FLAGS

Minimum 9 Flags Per Order



PW6X8DGPL

DIAGONAL NUMBERED FLAGS

Minimum 9 Flags Per Order



PW14X20DNS
REGULATION SINGLE NUMBER

PW14X20DND
REGULATION DOUBLE NUMBER

NUMBERED FLAGS

Minimum 9 Flags Per Order



PW6X8N PRACTICE GREEN

PW14X20N REGULATION

PW18X25N RANGE



TUBE STYLES

Hard Tubes

- Flag sits on flagstick with a hard, plastic internal tube.

Soft Tubes

- Flag sits on flagstick with a soft, nylon inner tube and grommet on top.

Grommets

- Flag connects to flagstick using 3 grommets (no tube). Requires swivel adapter on flagstick.

DIRT GUARDS



- Keep your flags looking new
- Six colors available
- Polyethylene cover fits securely over tube for a long-lasting, clean look!

PWDG PLASTIC DIRT GUARD

BORDERS & FABRIC SLEEVES



Red White Royal Blue Old Glory Blue Mustard Orange Brown Beige/Antique Gold Bone Medium Blue Light Blue



Charcoal Grey Silver Grey Fuchsia Teal / Turquoise Purple Yellow Kelly Green Forest Green Burgundy/Maroon Black Pink

PRACTICE GREEN LOGO FLAGS

SCREEN PRINTED



DOUBLE SIDED **PW6X8SP-**

Up to 6 colors
Minimum 9 flags per order
Single sided reads reverse on back
Double-sided reads correctly on both sides

EMBROIDERED



SINGLE SIDED **PW6X8E**

DOUBLE SIDED **PW6X8EDS**

Up to 6 colors
Minimum 9 flags per order
Single sided reads reverse on back
Double-sided reads correctly on both sides

DIGITAL PRINTED LOGO



PW6X8DP

Minimum 9 flags per order
Logo reads correct on both sides

DIGITAL LOGO FLAGS PHOTO QUALITY



Digital print flags are an excellent option for many uses

- Use for special tournaments with a custom logo
- Use for logos that are photo quality or have too much detail for screen printing
- Use if you want the logo to print out all the way to the edge of the flag - entire flag can be printed on

REGULATION FLAGS

PW14X20DPS SINGLE SIDED

PW14X20DPD DOUBLE SIDED

Minimum 9 flags per order

Digital logo flags can be printed on the entire flag from edge to edge.

EMBROIDERED U.S. PIN FLAGS



- Cut and stitched stars and stripes give a really high end look to this flag
- 14 in x 20 in regulation size
EMBROIDERED STARS & STRIPES

PW14X20USEMB REGULATION

DIGITAL PRINT U.S. PIN FLAGS



- Double sided digital printed american flag
- 14 in x 20 in regulation size

DIGITAL PRINT

| | |
|----------------------|-------------------|
| PW6X8DPUS | US PRACTICE GREEN |
| PW14X20DPUS | US REGULATION |
| PW6X8DP-TRL | THIN RED LINE-PG |
| PW14X20DP-TRL | THIN RED LINE-RG |
| PW6X8DP-TBL | THIN BLUE LINE-PG |
| PW14X20DP-TBL | THIN BLUE LINE-RG |

PIN PLACEMENT FLAGS

- Slide up or down to indicate hole position. And remind players to "Please Repair Ball Marks"
- Placement flags fit flagsticks up to 3/4" diameter.
- Rubber grommets included.
- Made with Dupont SolarMax Nylon
- Set of 9

| | 1/2" FLAGSTICK NO MESSAGE | 3/4" FLAGSTICK NO MESSAGE | 1/2" FLAGSTICK WITH MESSAGE | 3/4" FLAGSTICK WITH MESSAGE |
|--------|------------------------------|------------------------------|--------------------------------|--------------------------------|
| RED | STD05345 | STD05347 | STD05335 | STD05337 |
| YELLOW | STD05365 | STD05367 | STD05355 | STD05357 |
| WHITE | STD05371 | STD05372 | | |



Pricing is subject to change.

COLOR OPTION KEY



LOGO OPTION KEY



PREMIUM BAG RACK
74" L x 18" W x 32" H

- RCPBR1-5GN GREEN
- RCPBR1-5BK BLACK
- RCPBR1-5BR BROWN



CLUBHOUSE BAG RACK
74" L x 18" W x 32" H

- RCPBR-CH5-GN GREEN
- RCPBR-CH5-BK BLACK
- RCPBR-CH5-BR BROWN



IMPERIAL BAG RACK
74" L x 18" W x 46" H

- RCPBR-IL5-GN GREEN
- RCPBR-IL5-BK BLACK
- RCPBR-IL5-BR BROWN



IMPERIAL BAG RACK
74" L x 18" W x 46" H

- RCPBR-IL5-GN GREEN
- RCPBR-IL5-BK BLACK
- RCPBR-IL5-BR BROWN



DELUXE BAG RACK
46" L x 18" W x 36" H

- RCPBR-DCH5-GN GREEN
- RCPBR-DCH5-BK BLACK
- RCPBR-DCH5-BR BROWN



MODULAR 3 BAG RACK
44" L x 34" W x 18" H

- RCPBR-M3-GN GREEN
- RCPBR-M3-BK BLACK
- RCPBR-M3-BR BROWN



PERMANENT BAG RACK
Holds 10 Golf Bags

- RCPBR-PER5-GN GREEN
- RCPBR-PER5-BK BLACK
- RCPBR-PER5-BR BROWN



PREMIUM BAG RACK
Holds 10 Golf Bags

- RCPBR-PRT5-GN GREEN
- RCPBR-PRT5-BK BLACK
- RCPBR-PRT5-BR BROWN

CALL US TODAY FOR YOUR CUSTOM BAG RACK SOLUTION!

Bag racks can be customized with 5 to 8 bag stalls and logo for each style.

Call us for more color options as colors can be combined for two-tone look.



COLOR OPTION KEY



GREEN BROWN BLACK WALNUT GREY

Call us for more color & logo options. Colors can be combined for two-tone look.

LOGO OPTION KEY



LEXAN



ENGRAVED



CAST BRONZE



CAST ALUMINUM



BEECHWOOD SIDE LOAD TRASH CONTAINER

16 Gallon
17" L x 17" W x 31" H

- RCPTC-BW-GN HUNTER GREEN
- RCPTC-BW-BK BLACK
- RCPTC-BW-BR BROWN

SQUARE SLATTED TRASH CONTAINER

32 Gallon w/Lid & Liner
26" L x 20" W x 29" H



- RCPTC-SS32-GN HUNTER GREEN
- RCPTC-SS32-BK BLACK
- RCPTC-SS32-BR BROWN

SIERRA SQUARE TOP LOAD TRASH CONTAINER

26 Gallon w/Lid Off Lid & Liner
19" L x 19" W x 35" H



- RCPTC-TST26-GN HUNTER GREEN
- RCPTC-TST26-BK BLACK
- RCPTC-TST26-BR BROWN



CENTURY CURVE TOP SIDE LOAD TRASH CONTAINER

26 Gallon
19" L x 19" W x 37" H

- RCPTC-CT-GN HUNTER GREEN
- RCPTC-CT-BK BLACK
- RCPTC-CT-BR BROWN



DOUBLE RECYCLE CONTAINER

26 Gallon liners
37" L x 19" W x 45" H

- RCPRC-D26-GN HUNTER GREEN
- RCPRC-D26-BK BLACK
- RCPRC-D26-BR BROWN



TRIPLE TRASH & TOWEL STATION

26 Gallon liners
72" L x 19" W x 45" H

- RCPTCTS-T26-GN HUNTER GREEN
- RCPTCTS-T26-BK BLACK
- RCPTCTS-T26-BR BROWN



SIERRA SQUARE TOP LOAD TRASH CONTAINER

16 Gallon w/Lid Off Lid & Liner
17" L x 17" W x 28" H

- RCPTC-TST16-GN HUNTER GREEN
- RCPTC-TST16-BK BLACK
- RCPTC-TST16-BR BROWN



SQUARE SLATTED TRASH CONTAINER

32 Gallon w/Lid & Liner
26" L x 20" W x 24" H

- RCPTC-SS20-GN HUNTER GREEN
- RCPTC-SS20-BK BLACK
- RCPTC-SS20-BR BROWN

COLOR OPTION KEY



GREEN BROWN BLACK WALNUT GREY

Call us for more color & logo options. Colors can be combined for two-tone look.

LOGO OPTION KEY



LEXAN ENGRAVED CAST BRONZE CAST ALUMINUM



TRASH PRO 30
30 Gallon
28" L x 22" W x 43" H

- PAR3810 HUNTER GREEN
- PAR3811 BLACK
- PAR3812 REDWOOD



TRASH PRO 20
20 Gallon
20" L x 20" W x 32" H

- PAR3830 HUNTER GREEN
- PAR3831 BLACK
- PAR3832 REDWOOD

SQUARE TOP LOAD TRASH CONTAINER

16 & 25 Gallon w/Lid Off Lid & Liner
16" L x 16" W x 36" H



- RCPTCST16-GN HUNTER GREEN
- RCPTCST16-BK BLACK
- RCPTCST16-BR BROWN
- RCPTCST16-BB BLACK W/ BROWN TRIM
- RCPTCST16-GB GREEN W/ BLACK TRIM
- RCPTCST25-GN HUNTER GREEN
- RCPTCST25-BK BLACK
- RCPTCST25-BR BROWN
- RCPTCST25-BB BLACK W/ BROWN TRIM
- RCPTCST25-GB GREEN W/ BLACK TRIM

COMBINATION TRASH AND RECYCLE BIN

13 Gallon
18" L x 33" W x 35" H



- RCPTCDU-GN HUNTER GREEN
- RCPTCDU-BK BLACK
- RCPTCDU-BR BROWN
- RCPTCDU-BB BLACK W/ BROWN TRIM
- RCPTCDU-GB GREEN W/ BLACK TRIM



TRASH PRO 10
10 Gallon
18" L x 14" W x 33" H

- PAR3820 HUNTER GREEN
- PAR3821 BLACK
- PAR3822 REDWOOD

SQUARE SIDE LOAD TRASH CONTAINER

26 Gallon w/Lid Off Lid & Liner
19" L x 16" W x 41" H



- RCPTCSS26H-GN HUNTER GREEN
- RCPTCSS26H-BK BLACK
- RCPTCSS26H-BR BROWN

ROUND TRASH CANS

10 or 20 gallon



- RCPTCR10-GN 10 GAL HUNTER GREEN
- RCPTCR10-BK 10 GAL BLACK
- RCPTCR10-BR 10 GAL BROWN
- RCPTCR20-GN 20 GAL HUNTER GREEN

SQUARE REPLACEMENT TRASH LINERS

16 & 26 Gallons



- RCPTL-S16 SQUARE 16 GAL. \$175.75
- RCPTL-S26 SQUARE 26 GAL. \$184.25

ROUND REPLACEMENT TRASH LINERS

20 & 32 Gallons



- RCPTL-R20 ROUND 20 GAL.
- RCPTL-R32 ROUND 32 GAL.

9 GALLON TAPERED LITTER CADDIE



- STD13400 YELLOW WITH SPIKE
- STD13150 RED WITH SPIKE
- STD13152 RED WITH BASE
- STD13700 GREEN WITH SPIKE
- STD13800 GREEN WITH BASE
- STD13175 BLUE WITH SPIKE
- STD13177 BLUE WITH BASE
- STD13195 BLACK WITH SPIKE
- STD13197 BLACK WITH BASE
- STD13199 CUSTOM LOGO

30 GALLON TAPERED LITTER CADDIE



- Perfectly shaped to properly contain trash contents.
- 20-gauge steel with rich, durable powder-coat finish.
- 30 gallon capacity
- Shown with optional liner

- STD13028 YELLOW
- STD13053 RED
- STD13078 GREEN
- STD13083 BLUE
- STD13098 BLACK

20 GALLON STAINLESS LITTER CADDIE



- STD13953 RED WITH BASE
- STD13978 GREEN WITH BASE
- STD13998 BLACK WITH BASE
- STD13950 RED WITH SPIKE
- STD13975 GREEN WITH SPIKE
- STD13995 BLACK WITH SPIKE

LITTER CADDIE LINERS



- Roll them up and snap them open inside to preserve clean, longer-lasting Litter Caddies
- Flexible, black, polypropylene liners are easy to remove for cleaning
- Available in white or orange numbers and letters.
- 9 Gallon Price is for a set of 3
- 20 & 30 Gallon Prices are for a set of 2

- STD13850 9 GALLONS
- STD13870 20 GALLONS
- STD13860 30 GALLONS

CEASE FIRE CIGARETTE BUTT RECEPTACLE



- JUS26800D BLACK
- JUS26800G GREEN
- JUS26800B BEIGE
- JUS26800T TERRACOTTA

LITTER CADDIE COVERS



- Durable polyethylene container top
- Snaps onto 9-, 20- and 30-gallon caddy

- STD13190 9 GALLONS
- STD13090 30 GALLONS

IN-GROUND TRASH CAN

20 and 25 gallon



- Made from galvanized steel, lids are paintable.
- Steel grey in color.
- The foot pedal opens the top to drop it in the garbage.

- PWIG20-2 20 GALLON STEEL GREY
- PWIG25-2 25 GALLON STEEL GREY
- PWIGCCGN POWDER COAT GREEN LID
- PWIGCC POWDER COAT CUSTOM COLOR LID

Pricing is subject to change.

COLOR OPTION KEY



GREEN BROWN BLACK WALNUT GREY

Call us for more color & logo options. Colors can be combined for two-tone look.

LOGO OPTION KEY



LEXAN ENGRAVED CAST BRONZE CAST ALUMINUM



TRIPOD WATER COOLER STATION

- RCPWC01-GN HUNTER GREEN
- RCPWC01-BK BLACK
- RCPWC01-BR BROWN
- RCPWC01-BB BLACK W/ BROWN TRIM
- RCPWC01-GB GREEN W/ BLACK TRIM



DELUXE WATER COOLER STATION

- RCPWC03-GN GREEN
- RCPWC03-BK BLACK
- RCPWC03-BR BROWN



PAR AIDE WATER PRO ENCLOSURE

- PAR3610 GREEN
- PAR3611 BLACK
- PAR3612 REDWOOD



DELUXE DOUBLE WATER COOLER ENCLOSURE

- RCPWCE-DD-GN GREEN
- RCPWCE-DD-BK BLACK
- RCPWCE-DD-BR BROWN



KOOLER-AID IGLOO WATER STATION

Igloo Cooler & Cup Dispenser Included

- STD45150 GREEN
- STD45170 BLACK
- STD45125 RED



PAR AIDE WATER PRO JR.

- PAR3626 HUNTER GREEN
- PAR3627 BLACK
- PAR3628 REDWOOD

CALL US TODAY FOR YOUR CUSTOM COOLER STATION SOLUTION!

Call us for more color and logo options. Colors can be combined for two-tone look.

Coolers, cup dispensers, trash cans are sold separately unless specified below.



64 CLUBHOUSE FURNISHINGS

TOUCHLESS COOLER SPIGOT



- Attaches to Igloo coolers to allow access to water without the risk of bacteria or virus spread by touching the button.
- 5 inches x 3.5 inches
- Installs easily with no tools needed

GCAHFSPIGOT

IGLOO COOLERS



STD48400 5 GALLON

STD45400 10 GALLON
10 gal fits in water cooler stations

REPLACEMENT SPIGOTS



PAR3657-1

SOLO CONE CUPS



STD45650
4.25 OZ CUPS - CASE OF 5000

COOLER COVER LOCKS

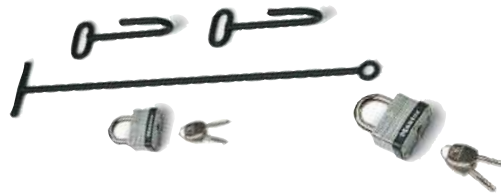

STD45700 COOLER COVER LOCK

STD45701 PADLOCK ONLY

REPLACEMENT CUP DISPENSERS



STD45600 DISPENSER

STD45605 TOP ONLY



FOLDING TRIPOD IGLOO WATER COOLER STAND

Stand Only, Cooler Sold Separately

RCPWC04-GN GREEN

RCPWC04-BR BROWN

RCPWC04-BK BLACK



CUSTOMIZE YOUR OWN BEVERAGE STATION!



Need a beverage station? All stations can be customized with or without logo, cup and lid dispensers, serving area, drawers and cabinets, and more! Call us for more color options as colors can be combined for two-tone look.

Pricing is subject to change.

COLOR OPTION KEY



LOGO OPTION KEY



CALL US TODAY FOR YOUR CUSTOM BENCH SOLUTION!

Slats and legs can be customized for the High back Bench, Heritage Bench, Rock Island Bench, and Anchored Mall Bench. Logos and custom memorial plaques can be added to any bench. Call us for more color and logo options.

HIGH BACK BENCH

Customized Color Slats, Leg Color, & Logo



- RCPB-HB4 4-FOOT
- RCPB-HB5 5 FOOT
- RCPB-HB6 6-FOOT

HERITAGE CLASSIC BENCH

Customized Color Slats, Leg Color, & Logo



- RCPB-HERB4 4-FOOT
- RCPB-HERB6 6-FOOT

ROCK ISLAND BACK BENCH

Customized Color Slats, Leg Color, & Logo



- STD400200 4-FOOT
- STD400300 6-FOOT

ANCHORED HIGH BACK MALL BENCH

Customized Color Slats, Leg Color, & Logo



- RCPB-AHB4 4-FOOT
- RCPB-AHB6 6 FOOT

CLASSIC HIGH BACK BENCH

5.5 Foot



- PAR620014 GREEN
- PAR620010 BLACK
- PAR620012 BROWN



CURVED BOTTOM MALL BENCH

5 Foot



- PAR620004 GREEN
- PAR620000 BLACK
- PAR620002 BROWN

MALL BENCH



- RCPB-MB4 4-FOOT
- RCPB-MB5 5-FOOT
- RCPB-MB6 6-FOOT

ANCHORED MALL BENCH



- RCPB-AM4 4-FOOT
- RCPB-AM7 7-FOOT



COMPRESSED AIR SHOE CLEANER HOUSING



- Blows dirt and grass off shoes with compressed air.
- Traps clippings in an easy-to-remove tray.
- Includes air wand.
- Air-compressor housing sold separately
- Our air compressor is designed to fit perfectly in housing unit.

- RCPSC1-GN** GREEN
- RCPSC1-BK** BLACK
- RCPSC1-BR** BROWN
- PWPCLOGO** ADD LOGO- CALL FOR PRICING

OPTIONAL AIR COMPRESSOR HOUSING UNIT



- STD100199GN** GREEN
- STD100199BK** BLACK
- STD100199BR** BROWN
- PWPCLOGO** ADD LOGO- CALL FOR PRICING

AIR COMPRESSOR

Fits Housing Unit



- MAKMAC700** 110 VOLT AIR COMPRESSOR
- SHPAHOIL25** COMPRESSOR HOSE
- SHPAFKIT** COMPRESSOR FITTINGS - 5-PIECE

24" AIR BLOW GUN

SHPABGSC



DUO-KLEENER STAND

Standard Golf

- Anchors in asphalt or in turf
- Includes stand, brushes, hardware and mounting spikes

STD36650

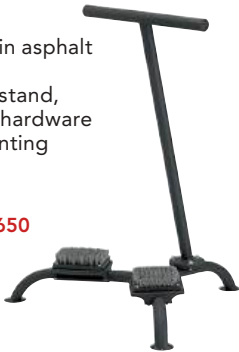

PORTABLE SPIKE BRUSH

Par Aide

- Two base brushes and side brushes to thoroughly clean shoes
- Holds steady on hard surfaces with integral rubber pads; spikes available to secure to turf



- PAR512-11** GREEN
- PAR511-11** BLACK

SCRUSHER



- STD14100** SCRUSHER
- STD14102** REPLACEMENT BOTTOM BRUSH
- STD14103** REPLACEMENT SIDE BRUSH

REPLACEMENT SPIKE KLEENER BRUSH

Standard Golf

STD14252



REPLACEMENT SPIKE BRUSH

Par Aide

PAR554-11



REPLACEMENT SIDE BRUSH

Par Aide

PAR548



Pricing is subject to change.



E-Z UP EVENT SYSTEMS™

REFRESH YOUR TOURNAMENT ACCESSORIES
OR ADD BRAND NEW ONES WITH PAR WEST!

At Par West, we're proud to offer EZ-UP, a customized and adaptable system designed to help you stand out at golf course events. Whether you're hosting tournaments, promotional activities, or special events, our EZ-UP solutions provide the perfect platform to increase customer interest and engagement.



CALL US
TODAY FOR
YOUR CUSTOM
EZ-UP
SOLUTION!



TEE DIVIDERS



A-FRAME EASELS



DIRECTORS CHAIRS



6" TABLE COVERS



BLADE FLAGS



10' SIDEWALLS



WHY CHOOSE PAR WEST FOR EZ-UP?

Customization: Showcase your brand with personalized canopies, banners, and accessories. Create an environment that reflects your unique identity while drawing attention to your event.

Adaptability: Lightweight, durable, and easy to set up, EZ-UP products are versatile enough to meet the needs of any golf course event, from casual gatherings to formal tournaments.

Professional Appeal: Establish a polished, professional presence that attracts and retains customer attention.

Enhanced Engagement: Create a welcoming and functional space that fosters interaction and leaves a lasting impression.

With Par West's EZ-UP Dealer Solutions, you'll have everything you need to transform your events into unforgettable experiences. Boost visibility, enhance customer interaction, and make your golf course events a resounding success.

CUSTOM LOGO CLUBHOUSE FLAGS



- PW3X5DP 3' X 5'
- PW4X6DP 4' X 6'
- PW5X8CLUBHOUSE 5' X 8'
- PW6X10CLUBHOUSE 6' X 10'

Clubhouse flags are digital printed logos - single sided

CLUBHOUSE STATE FLAGS



- PW3X5STATE 3' X 5'
- PW4X6STATE 4' X 6'
- PW5X8STATE 5' X 8'
- PW6X10STATE 6' X 10'

State flags are nylon and digital printed logos - single sided

CLUBHOUSE USA FLAGS



- PW3X5USFLAG 3' X 5' US FLAG
- PW4X6USFLAG 4' X 6' US FLAG
- PW5X8USFLAG 5' X 8' US FLAG
- PW6X10USFLAG 6' X 10' US FLAG

US flags are nylon and digital printed logos - single sided

GOLF SCORE CARD PENCILS

- Personalized pencils come in 4 different varieties: hex, hex with eraser, round and round with eraser
- Print up to three lines of your company or course information on the pencils
- Pencil colors: Dark Green, Blue, Red, Cranberry, Black, White, Natural, Maroon
- Also available in - Neon pink, neon yellow, neon green & neon orange.
- Metallic Imprint color options - (Metallic) Gold, Silver, Red, Blue, Green, Copper, Purple, Metallic Green
- Non-Metallic Imprint color options - Black, White

ROUND WITH ERASER



DRRERPE-L PRINTED LOGO- 25 GROSS (3600 PENCILS)

* 25 gross minimum order. Art set-up fees may apply

HEX WITH ERASER



DREHPE PRINTED LOGO - 25 GROSS (3600 PENCILS)

* 25 gross minimum order. Art set-up fees may apply

ROUND NON ERASER



DRERP-L PRINTED LOGO - 25 GROSS (3600 PENCILS)

* 25 gross minimum order. Art set-up fees may apply

HEX NON ERASER



DREHP-L PRINTED LOGO - 25 GROSS (3600 PENCILS)

* 25 gross minimum order. Art set-up fees may apply

PLAIN GOLF PENCILS

- Prices are per gross (144 per gross)
- Available in red, green, black or blue
- Discounts available for large orders



DRRERPE ROUND W/ERASER

DREHPE HEX W/ ERASER

DRERP ROUND

DREHP HEX

Pricing is subject to change.

NEW DESIGN!

PERMA-CORE CLOSEST TO THE PIN

Measuring Tape & Handle



CTTP COLOR OPTION KEY



- Comes standard with 25 cards
- Comes with 50' tape measure
- Made with our Perma-Core Plastic

- PWPCCPM-C-COLOR** CUSTOM MARKER KIT
- PWPCCPM-COLOR** PLAIN MARKER KIT
- GCACPMs** REPLACEMENT CARDS (25 PACK)

CLOSEST TO THE PIN

Measuring Tape



- Comes standard with 25 cards
- Comes with 50' tape measure

- GCACPM** MEASURING MARKER KIT
- GCACPMs** REPLACEMENT CARDS (25 PACK)

LONG DRIVE MARKER

W/ Clipboard



- Comes standard with clipboard and base
- Flag not included
- Made with our Perma-Core Plastic

- PWLDD-C-COLOR** CUSTOM MARKER KIT
- PWLDD-COLOR** PLAIN MARKER KIT

Use Our Perma-Core Color Option Key At The Top To Choose Your Color for Long Drive and Closest to the Pin Markers!

PROXIMITY MARKERS

With Paper Sheets



- DREPM** MARKER SET (4)
- DREPM-25** REPLACEMENT CARDS (25 PACK)

PROXIMITY MARKERS

Reusable / Dry Erase



- PAR10600** PROXIMITY MARKER
- PAR10602** CONTEST INDICATOR
- PAR10620** CUSTOM PROXIMITY MARKER
- PAR10622** CUSTOM CONTEST INDICATOR
- PAR10690** REPLACEMENT PEN W/ VELCRO
- PAR10691** TUBE OF 6 REPLACEMENT LEADS

Erasable (no paper)
Can be customized

70 TOURNAMENT & GOLF SHOP SUPPLIES

FRAMED FLAGS

Multiple Options Available



SMALL FLAG FRAME



LARGE FLAG FRAME

HOLE-IN-ONE FRAMED FLAG

PERFECT FOR YOUR HOLE IN ONE SHOT!

- WITH FLAG, SCORECARD, BALL, AND PLATE
- SIZE VARIES BY SIZE OF SCORECARD
- FLAG SIZE: 8" X 12"

Matte Colors

We offer 7 matte colors: black, white, beige, forest, blue, maroon, and red. Please call for custom matte color & double matte options.

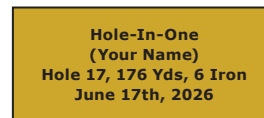

Plate Specifications

4 Lines of text, 26 characters wide. Standard card stock plate available in gold or silver. Additional options include, logo's, brass plates with engraved text, and oversized plates. Please call for details.

CALL FOR PRICING

- PWFF-SM** SMALL FRAMED FLAG
- PWFF-LG** LARGE FRAMED FLAG
- PWFF-HIO** HOLE-IN-ONE FRAMED FLAG



TOUR CADDIE BIBS

PolyCotton Twill & Poly Mesh Options



- Embroidery, silk screen, and digital print options
- Player patch available
- Logos priced separately
- Two front pockets
- Back pockets available

CALL FOR PRICING

- PWTCB-EM** EMBROIDERED
- PWTCB-SK** SILK
- PWTCB-DP** DIGITAL PRINT

LOGO IMPRINTED BALL MARKERS

Dime & Quarter Sizes



- Colors Available: White, Black, Blue, Grey, Neon Orange, Red, Yellow, Citrus Pink, Citrus Yellow & Citrus Orange
- Sold in cases of 10,000
- Wood & plastic options

CALL FOR PRICING

- PWLIMB-DP** DIME PLAIN
- PWLIMB-DI** DIME IMPRINT
- PWLIMB-QP** QUARTER PLAIN
- PWLIMB-QI** QUARTER IMPRINT

LOGO IMPRINT DIVOT TOOLS

Dime & Quarter Sizes



- Minimum 250 pieces
- No set up fees

CALL FOR PRICING

- PWLIDT-DP** DIME PLAIN
- PWLIDT-DI** DIME IMPRINT
- PWLIDT-QP** QUARTER PLAIN
- PWLIDT-QI** QUARTER IMPRINT

BAG TAGS

- Molded from high impact styrene.
- Colors available: white, black, red, light blue, dark blue, beige, gray, green, yellow and orange
- Choose from styles below
- Extra side or extra colors in logo will have additional costs

| PART # | DESCRIPTION |
|-------------------|--|
| A DREBT275 | 2" X 3 1/2" RECTANGLE WITH NAME SLOT AT BOTTOM |
| B DREBT350 | 3 1/2" ROUND TAG WITH NAME CHANNEL |
| C DREBT462 | 4 1/2" FLEXIBLE GUEST TAG WITH BUILT IN STRAP |
| D DREBT450 | 2 7/8" X 3 5/8" SHIELD TAG |
| E DREBT385 | 3 1/2" SQUARE TAG WITH NAME CHANNEL |
| F DREBT400 | 3 1/4" X 3 1/2" TRAPEZOID WITHOUT NAME CHANNEL |
| G DREBT475 | 5" X 3 3/4" INCH TAG |
| H DREBT490 | 5 1/2 X 4 INCH DIAMOND WITH TWO NAME CHANNELS |
| I DREBT495 | DIAMOND TAG |
| J DREBT480 | 3 1/2 X 3 7/8 INCH TAG |
| K DREBT485 | 3 1/2 X 4 1/2 INCH RECTANGLE |
| L DREBT375 | 3 1/4" X 4" OVAL TAG WITH NAME CHANNEL |



Pricing is subject to change.

POUR CADDY STAINLESS STEEL FLASK SET
Pro Shop Ready Member Merchandise



- "19th-hole ready" premium add-on: a sleek, insulated 20oz reservoir that feels high-end on the shelf and in-hand.
- Built for golf: flip-top pour spout + leakproof design = no mess in carts, bags, or lockers.
- The feature that closes the sale: 4 hidden 2oz shot cups tucked in the removable base - easy to share, easy to stash.
- Cold stays cold: double-wall, vacuum-insulated stainless keeps beverages at the right temp for hours.
- Easy pro shop win: giftable, conversation-starting, and ideal for member-guest, leagues, outings, holiday gifting, and prize tables.
- Club-branded revenue: custom engraving turns each unit into a walking clubhouse billboard.
- Color variety that merchandises well: multiple colorways make a clean, "collectible" display.

| | |
|---------------|--------------|
| PCF-IB | ICE BLUE |
| PCF-BK | SHADOW BLACK |
| PCF-WH | GLORY WHITE |
| PCF-RD | GLORY RED |
| PCF-BL | GLORY BLUE |
| PCF-LI | LILAC |

18OZ. & 28OZ GO CADDY VIBE TUMBLERS

The Perfect Member-guest Hero Item For Golf Courses

18 OZ TUMBLERS



28 OZ TUMBLERS



- Pro-shop friendly: high perceived value, easy to demo ("tap to play music / charge a phone / light up the cupholder area").
- Premium tumbler that members actually use: double-wall stainless insulation keeps drinks hot/cold through long rounds and practice sessions.
- Brand it once, sell it year-round: custom engraving makes it a staple for member swag, new-member gifts, and tournament packages.
- Modern "wow" factor: modular options turn a tumbler into a speaker / power bank / LED light setup—perfect for carts, range nights, and travel.
- Two sizes = broader buyer base: stock both 18oz + 28oz to fit different preferences and price sensitivities.
- Color options that fit every club aesthetic: neutrals + bolds for clean merchandising and sponsor-friendly bundles.

| | | | | |
|------------------|-------------------|-----------------------|------------------------|------------------------|
| | | | | |
| RED - RD | WHITE - WH | NAVY BLUE - NB | DARK GREEN - DG | GREY - GY |
| | | | | |
| PINK - PK | BLACK - BK | SANDSTONE - SD | SEAFOAM - SF | WATER BLUE - WB |

SOLO SPEAKER - SS



LED LIGHT - L



POWER BANK - PB



18OZ TUMBLER-

GCV18-ACCESSORY BASE-COLOR

28 OZ TUMBLER-

GCV28-ACCESSORY BASE-COLOR

72 TOURNAMENT & GOLF SHOP SUPPLIES



PORTABLE TOURNAMENT COOLERS WITH LOGO

65 Quart & 125 Quart

- Tournament-day essential: designed for outings, member-guests, leagues, and corporate events - the cooler every group needs.
- Sponsor magnet: large logo area makes it an easy "title sponsor" or "cart sponsor" upgrade - high visibility all day.
- Revenue + cost recovery: offer as a paid add-on in tournament packages or include in premium tiers to lift per-player revenue.
- Club branding that lasts: add your club logo (or event logo) and reuse season after season.

| | | |
|--------------------|---------------|----------|
| GCALC65-WH | 65 QT. WHITE | \$395.00 |
| GCALC65-TN | 65 QT. TAN | \$395.00 |
| GCALC65-BL | 65 QT. BLUE | \$395.00 |
| GCALC125-WH | 125 QT. WHITE | \$585.00 |
| GCALC125-TN | 125 QT. TAN | \$585.00 |
| GCALC125-BL | 125 QT. BLUE | \$585.00 |

COLOR OPTION KEY



LOGO OPTION KEY



LEXAN ENGRAVED CAST BRONZE CAST ALUMINUM



ICE CHEST CABINET WITH TRASH & RECYCLABLES ENCLOSURE

| | |
|----------------------|-------|
| RCPIC-CTRE-GN | GREEN |
| RCPIC-CTRE-BK | BLACK |
| RCPIC-CTRE-BR | BROWN |



COOLER PRO

Includes 48 Quart Cooler

| | |
|----------------|--------------|
| PAR3330 | HUNTER GREEN |
| PAR3331 | BLACK |
| PAR3332 | REDWOOD |



LARGE TALL ICE CHEST*

108 Qt & 54 Qt Coolers (162 Quart Total)

| | |
|------------------------|-------|
| RCPIC-TLG162-GN | GREEN |
| RCPIC-TLG162-BK | BLACK |
| RCPIC-TLG162-BR | BROWN |



MEDIUM TALL ICE CHEST*

108 Quart Cooler

| | |
|------------------------|-------|
| RCPIC-TMD108-GN | GREEN |
| RCPIC-TMD108-BK | BLACK |
| RCPIC-TMD108-BR | BROWN |



SMALL TALL ICE CHEST*

54 Quart Capacity

| | |
|-----------------------|-------|
| RCPIC-TSM54-GN | GREEN |
| RCPIC-TSM54-BK | BLACK |
| RCPIC-TSM54-BR | BROWN |

*Large, Medium, and Small Tall Ice Chests are also available in low options.

CALL US TODAY FOR YOUR CUSTOM COOLER SOLUTION!

Call us for more color and logo options. Colors can be combined for two-tone look.



Pricing is subject to change.



CLOCK EASEL- ECONOMY

24" Tall x 16" Wide

- Perma core plastic easel with clock included
- Add logo for extra charge

PWPC-CE-SS- _ SINGLE SIDED

PWPC-CE-DS- _ DOUBLE SIDED

EASEL COLOR OPTION KEY



CLOCK EASEL- DELUXE

32" Tall x 24" Wide

- Perma core plastic easel with clock included
- Add logo for extra charge

PWPCDCE-SS- _ SINGLE SIDED

PWPCDCE-DS- _ DOUBLE SIDED



CLUBHOUSE AND STARTER SIGNS WITH CLOCKS

SHAPE 11



SHAPE 4



SHAPE 2



SIGN COLOR OPTION KEY



- Available in 12 color options
- Can be mounted to a post, hung from metal post, or mounted to wall.
- Mounting sold separately.
- Messages can be modified to fit your needs
- Add color option to end of part number

PWPC1424SC-S11_ 14" X 24" PLEASE KEEP PACE OF PLAY - SHAPE 11

PWPC1424SC-S4_ 14" X 24" PLEASE KEEP PACE OF PLAY - SHAPE 4

PWPC1424SCS-S2_ 14" X 24" TODAY'S COURSE RULES W/ SLIDERS- SHAPE 2

PWPC2436SCS-S2_ 24" X 36" TODAY'S COURSE RULES W/ SLIDERS- SHAPE 2

RECYCLED PLASTIC MOUNTING POST OPTIONS

5, 6, 7, Or 8 Feet Options



- Black, White, Brown, and Green Options Available.
- 4 inch x 4 inch material
- Great for perma-core plastic signs

RCPPOST4460- _ 5' POST

RCPPOST4472- _ 6' POST

RCPPOST4484- _ 7' POST

RCPPOST4496- _ 8' POST

See other sign post options on page 27!



CLOCKS ONLY

STD200900 WHITE, 12" - OUTDOOR WATER RESISTANT

STD200902 ATOMIC SILVER, 18" - OUTDOOR WATER RESISTANT

STD200901 BROWN, 15"

RECYCLED LUMBER PODIUMS

RECYCLED LUMBER STARTER PODIUM



- RPCSP2-GN** GREEN
- RPCSP2-BK** BLACK
- RPCSP2-BR** BROWN
- RPCSP2-BB** BLACK W/ BROWN TRIM
- RPCSP2-GB** GREEN W/ BLACK TRIM

TOURNAMENT PODIUM

Logo & Plain 18"L x 32"W x 46"H



**W/LOGO-
NO LOGO-**

- RCPP-TL-GN** GREEN
- RCPP-TL-BK** BLACK
- RCPP-TL-BR** BROWN

**POIDIUM UMBRELLA
BRACKET HOLDERS**

- RCPUK-GN** GREEN
- RCPUK-BK** BLACK
- RCPUK-BR** BROWN



COLOR OPTION KEY



LOGO OPTION KEY



All podiums and towel stations can be customized with logo or without. Call us for more color options as colors can be combined for two-tone look.

GRAND PODIUM

Logo & Plain - 21"L x 63"W x 47"H



- RCPP-G-GN** GREEN
- RCPP-G-BK** BLACK
- RCPP-G-BR** BROWN

DELUXE PODIUM

Logo & Plain -18"L x 32"W x 46"H



**W/LOGO-
NO LOGO-**

- RCPP-DL-GN** GREEN
- RCPP-DL-BK** BLACK
- RCPP-DL-BR** BROWN

COMMERCIAL MARKET UMBRELLAS
9 Foot With Tilt



- High quality fabric - 9 Foot diameter
- 5 year warranty on colorfastness, bleach cleanable, water-repellent but breathable, high-end design
- Aluminum umbrella frame is 20% stronger than most of the umbrellas in the market
- Rust Free Powder Coated with 8 Ribs
- Crank open system - easy to open and close by the crank handle. Press push button to tilt for more shade

- GCAUMB-RB** ROYAL BLUE
- GCAUMB-RD** BURGUNDY RED
- GCAUMB-FG** FOREST GREEN
- GCAUMB-BK** BLACK

UMBRELLA BASE



- plastic base fills with sand or water to give it a weight of 50 pounds when full
- lightweight for shipping keeps freight costs low
- handle makes it easy to move

GCAUB

Pricing is subject to change.

COLOR OPTION KEY



Call Us For More Color Options. Color options only available for scorecard caddies below.

PRESIDENTIAL SCORECARD CADDIE

4"x 4" x 60" Post



- RCPSCC-P-GN** GREEN
- RCPSCC-P-BR** BROWN
- RCPSCC-P-BK** BLACK

EXCLUSIVE SCORECARD CADDIE

4"x 4" x 60" Post



- RCPSCC-E-GN** GREEN
- RCPSCC-E-BR** BROWN
- RCPSCC-E-BK** BLACK

SCORECARD CADDIE ON 5" POST

4"x 4" x 60" Post



- RCPSCC-5-GN** GREEN
- RCPSCC-5-BR** BROWN
- RCPSCC-5-BK** BLACK

SCORECARD CADDIE W/PORTABLE BASE

4"x 4" x 60" Post



- RCPSCC-PB-GN** GREEN
- RCPSCC-PB-BR** BROWN
- RCPSCC-PB-BK** BLACK

SCORECARD CADDY

4"x 4" x 52" Post



- The Scorecard Caddy makes organization simple and interchangeable with your course.
- Interchangeable dividers allow for custom organization of scorecards of all sizes, tees, pencils, ball makers and ball mark repair tools

- PAR3358** GREEN W/ 52" GREEN POST
- PAR3359** GREEN W/ 52" BLACK POST
- PAR3360** BLACK W/ 52" BLACK POST
- PAR3361** REDWOOD W/ 52" BLACK POST
- PAR3358-2** GREEN CADDY ONLY
- PAR3358-0** BLACK CADDY ONLY
- PAR3358-11** REDWOOD CADDY ONLY

GOLF SCORE CARD PENCILS

- Personalized pencils come in 4 different varieties: hex, hex with eraser, round and round with eraser
- Print up to three lines of your company or course information on the pencils
- Pencil colors: Dark Green, Blue, Red, Cranberry, Black, White, Natural, Maroon
- Also available in - Neon pink, neon yellow, neon green & neon orange.
- Metallic Imprint color options - (Metallic) Gold, Silver, Red, Blue, Green, Copper, Purple, Metallic Green
- Non-Metallic Imprint color options - Black, White

HEX WITH ERASER



* 25 gross minimum order.
Art set-up fees may apply

DREHPLE PRINTED LOGO
25 GROSS (3600 PENCILS)

ROUND WITH ERASER



* 25 gross minimum order.
Art set-up fees may apply

DRERPE-L PRINTED LOGO
25 GROSS (3600 PENCILS)

PLAIN GOLF PENCILS



- Prices are per gross (144 per gross)
- Available in red, green, black or blue
- Discounts available for large orders

- DRERPE** ROUND W/ERASER
- DREHPE** HEX W/ ERASER
- DRERP** ROUND
- DREHP** HEX

HEX NON ERASER



* 25 gross minimum order.
Art set-up fees may apply

DREHP-L PRINTED LOGO
25 GROSS (3600 PENCILS)

ROUND NON ERASER

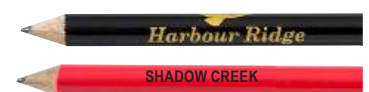

* 25 gross minimum order.
Art set-up fees may apply

DRERP-L PRINTED LOGO
25 GROSS (3600 PENCILS)

PREMIUM LASER CUT TEE MARKERS

Thick-Cut Stainless Steel Build



- Choose any color
- Our in house artist will help convert your logo into a laser cut design at no charge
- Durable, low maintenance and affordable
- Most designs will fall into our common size price below, but we will give you a quote if you have a more complicated design
- Normal dimensions are 4" wide x 8" tall

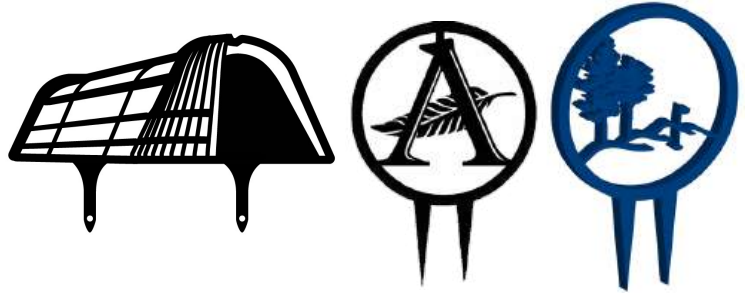

GCALCTM COMMON SIZES AND DESIGNS

ECONOMY LASER CUT TEE MARKERS

Thin-Cut Stainless Steel Build



* These tee markers are more economical option, but not as durable as the premium option above.

- Made of high quality stainless steel in a single color powder coated finish
- 10.5" height, custom laser cut design fits 6"x 6" diameter
- Minimum order of 18

- STD05900** RED
- STD05901** WHITE
- STD05902** BLUE
- STD05903** YELLOW
- STD05904** BLACK
- STD05905** GOLD
- STD05906** ORANGE
- STD05907** GREEN
- STD05908** PURPLE
- STD05909** CUSTOM COLOR

EVENT TEE MARKERS

4" x 4" Plastic



- cube-shaped markers allow you to display whatever you want- whether it's event graphics, the name of the hole sponsor or other information-on four surfaces. Spike is placed for a square, cubed look
- Minimum order of 36
- Designed with special adhesive, the decals hold securely, but can be removed leaving minimal residue after the event.

- PAR670-1** RED
- PAR670-5** BLACK
- PAR670-10** 4"X4" DECALS - PK/80

Pricing is subject to change.

CAST ALUMINUM & BRONZE TEE MARKERS

- Cast aluminum & bronze tee markers are made with the highest quality standards.
- All markers include two 4" stainless steel mounting spikes.
- Choose the background color and texture that best combines with your logo and needs.

STEP 1 - CHOOSE YOUR MATERIAL

CAST ALUMINUM

CAST BRONZE



STEP 2 - CHOOSE YOUR SIZE & SHAPE



1

SIZE ALUMINUM BRONZE
4" X 6"
5" X 7"



2

SIZE ALUMINUM BRONZE
4" X 6"
5" X 7"



3

SIZE ALUMINUM BRONZE
4" X 6"
5" X 7"



4

SIZE ALUMINUM BRONZE
6" X 4"
7" X 5"



5

SIZE ALUMINUM BRONZE
6" X 4"
7" X 5"



6

SIZE ALUMINUM BRONZE
6" X 4"
7" X 5"



7

SIZE ALUMINUM BRONZE
5"
6"
Available in round or square



8

SIZE ALUMINUM BRONZE
5"
6"
Available in round or square

CUSTOM SHAPES AVAILABLE!
CALL FOR PRICING



Setup charge will apply to all orders (including reorders) with less than 30 units

FORE-EVER TEE MARKERS

3" & 4" Sizes with Neck or Round Style

- One of our most popular and most economical tee markers from courses on both ends of the budget spectrum
- Made from a special blend of resins
- Incredibly durable with a mirrored finish
- UV stable and will never need painting
- Three sizes available - contact us for 5 inch part numbers
- Fitted with a stainless steel spike
- Add an engraved logo for extra charge per marker



4 INCH 3 INCH



ROUND STYLE



NECK STYLE

3" - 4" -

RED



ROUND NECK

GCAEVR-3-RD GCAEVN-3-RD
GCAEVR-4-RD GCAEVN-4-RD

WHITE



ROUND NECK

GCAEVR-3-WH GCAEVN-3-WH
GCAEVR-4-WH GCAEVN-4-WH

BLUE



ROUND NECK

GCAEVR-3-BL GCAEVN-3-BL
GCAEVR-4-BL GCAEVN-4-BL



YELLOW



ROUND NECK

GCAEVR-3-YW GCAEVN-3-YW
GCAEVR-4-YW GCAEVN-4-YW

HUNTER GREEN



ROUND NECK

GCAEVR-3-HG GCAEVN-3-HG
GCAEVR-4-HG GCAEVN-4-HG

ORANGE



ROUND NECK

GCAEVR-3-OR GCAEVN-3-OR
GCAEVR-4-OR GCAEVN-4-OR



BLACK



ROUND NECK

GCAEVR-3-BK GCAEVN-3-BK
GCAEVR-4-BK GCAEVN-4-BK

METALLIC GOLD



ROUND NECK

GCAEVR-3-MG GCAEVN-3-MG
GCAEVR-4-MG GCAEVN-4-MG

GREY



ROUND NECK

GCAEVR-3-GY GCAEVN-3-GY
GCAEVR-4-GY GCAEVN-4-GY

Call us for a quote to add your logo to our Fore-Ever Tee Marker above at additional cost.

RE-NEW-A-TEE

Resin Tee Marker Renewal Kit

PAR635600 2 PART KIT



- Restore your Fore-Ever Marked Tee Markers to their original high gloss finish
- Two part clear coat epoxy kit
- Simply sand, clean and dip into epoxy and let dry overnight
- Restores approximately 172 4" Tee Markers

Pricing is subject to change.

PERMA-CORE TEE MARKERS

SHOWCASE TEE MARKERS WITH LOGO

6.5" Diameter



SINGLE-SIDED - PWPCTMSH-__
DOUBLE-SIDED - PWPCTMSHD-__

DOMED TEE MARKERS WITH LOGO

6.5" Wide, 5" Tall



SINGLE-SIDED- PWPCTMD-__
DOUBLE-SIDED- PWPCTMDD-__

TEE MARKER COLOR OPTION KEY



SHIELD TEE MARKERS WITH LOGO

6.5" Diameter



SINGLE-SIDED- PWPCTMS-__
DOUBLE-SIDED- PWPCTMSD-__

LOLLIPOP LOGO TEE MARKERS

6.5" Diameter



SINGLE-SIDED- PWPCTML-__
DOUBLE-SIDED- PWPCTMLD-__

LOLLIPOP NUMBERED TEE MARKERS

6.5" Diameter



SINGLE-SIDED- PWPCTMN-__
DOUBLE-SIDED- PWPCTMND-__

PLAIN LOLLIPOP TEE MARKER

6.5" Diameter



- PWPCTME-5 RED
- PWPCTME-2 WHITE
- PWPCTME-4 BLUE
- PWPCTME-8 YELLOW
- PWPCTME-3 BLACK
- PWPCTME-1 GREEN



DOGWOOD BRANCH TEE MARKER

9.5" X 2"



Add logo for extra charge. See below.

- PAR632-1 RED
- PAR632-2 WHITE
- PAR632-3 BLUE
- PAR632-4 YELLOW
- PAR632-5 BLACK
- PAR632-6 GREEN
- PAR632-7 GOLD

PINE BRANCH TEE MARKER

9.5" X 2"



Add logo for extra charge. See below.

- PAR630-1 RED
- PAR630-2 WHITE
- PAR630-3 BLUE
- PAR630-4 YELLOW
- PAR630-5 BLACK
- PAR630-6 GREEN
- PAR630-7 GOLD

OAK WOOD TEE MARKER

4.25"H X 4"W



- STD05620 RED
- STD05621 WHITE
- STD05622 BLUE
- STD05623 YELLOW
- STD05624 BLACK
- STD05625 GOLD
- STD05626 ORANGE
- STD05627 GREEN
- STD05628 PURPLE

WEDGE TEE MARKER

5"H X 4"W X 3" Rear Spike



Add logo for extra charge. See below.



- STD05150 RED
- STD05151 WHITE
- STD05152 BLUE
- STD05153 YELLOW
- STD05155 BLACK

PERSONALIZED DIMPLE TEE MARKER

5" Diameter



Add logo for extra charge. See below.



- STD05270 RED
- STD05271 WHITE
- STD05272 BLUE
- STD05273 YELLOW
- STD05275 BLACK
- STD05276 SILVER
- STD05277 GOLD
- STD05278 ORANGE
- STD05279 GREEN

CAST ALUMINUM TEE MARKER

5" Diameter



Add logo for extra charge. See below.



- STD05750 RED
- STD05751 WHITE
- STD05752 BLUE
- STD05753 YELLOW
- STD05755 BLACK
- STD05759 GREEN

ADD YOUR LOGO TO ANY TEE MARKER!

Logos are applied using digital printed vinyl or hand-cut vinyl, depending on your logo style and artwork requirements.

Add logo customization to any of these tee markers for an additional \$4.00 per marker. Free artwork included.



PWVL-3R

Pricing is subject to change.

CROWN ALUMINUM TEE MARKER

6" Diameter 2" High



- STD05700 RED
- STD05701 WHITE
- STD05702 BLUE
- STD05703 YELLOW
- STD05705 BLACK
- STD05709 GREEN
- STD05710 PINK

BANDED TEE MARKER

5" Diameter



- PAR660- CHARCOAL GRANITE
- PAR661- GREY GRANITE
- PAR663- SAND GRANITE

BAND COLOR OPTIONS



CAPITAL BRAZILIAN WALNUT TEE MARKER W/ VINYL STRIP

4"H x 4"W



- RCPTM-CS-RD RED
- RCPTM-CS-WH WHITE
- RCPTM-CS-BU BLUE
- RCPTM-CS-YW YELLOW
- RCPTM-CS-BK BLACK
- RCPTM-CS-GN GREEN
- RCPTM-CS-MG METALLIC GOLD
- RCPTM-CS-MS METALLIC SILVER

DIMPLE TEE MARKER

5" Diameter



- STD05250 RED
- STD05251 WHITE
- STD05252 BLUE
- STD05253 YELLOW
- STD05255 BLACK
- STD05256 SILVER
- STD05257 GOLD
- STD05258 ORANGE
- STD05259 GREEN

CLASSIC TEE MARKER

3" Diameter



- STD05600 RED
- STD05601 WHITE
- STD05602 BLUE
- STD05603 YELLOW
- STD05604 BLACK
- STD05605 ORANGE
- STD05606 GREEN

CUBE TEE MARKER

3.5" x 3.5"



- PAR633701 RED
- PAR633702 WHITE
- PAR633703 BLUE
- PAR633704 YELLOW
- PAR633705 GREEN
- PAR633706 BLACK



BROKEN TEE CADDIE

- Sleek cone-shaped design
- Powder-coated steel
- 6" high w/ 5" spike



- STD19000 BLACK
- STD19015 YELLOW
- STD19025 RED
- STD19050 GREEN
- STD19075 BLUE
- STD19085 ORANGE
- STD19095 WHITE



DIMPLE-T BROKEN TEE CADDIE

- 5" Diameter w/ 4.5" spike



- STD05280 RED
- STD05281 WHITE
- STD05282 BLUE
- STD05283 YELLOW
- STD05285 BLACK
- STD05286 SILVER
- STD05287 GOLD
- STD05288 ORANGE
- STD05289 GREEN



OAK BROKEN TEE CADDIE

- Customizable stripe with color and logo available - minimum order of 36 minimizes footprint
- Priced individually, sold in sets of 2.
- 4.25" H x 4" W w/ 3.5" spike



- STD05520 RED
- STD05521 WHITE
- STD05522 BLUE
- STD05523 YELLOW
- STD05524 BLACK
- STD05525 GOLD
- STD05526 ORANGE
- STD05527 GREEN
- STD05528 PURPLE



RECYCLED BROKEN TEE CADDIE

- Keep tee areas tidy •
- Recycled plastic sides with powder-coated steel mesh bottom
- 9 1/2 in. x 7 1/2 in. x 2 1/2 in. (24 cm x 19 cm x 6 cm)

- PAR3490 GREEN
- PAR3492 REDWOOD
- PAR3491 BLACK



MASTER BALL WASHER ENSEMBLE



- PAR50-** MASTER ENSEMBLE (NO TRASH)
- PAR51-** MASTER ENSEMBLE W/ SINGLE TRASH MATE
- PAR52-** MASTER ENSEMBLE W/ DOUBLE TRASH MATE

**CHOOSE COLORS RED (-01), GREEN (-02), BLACK (-00) OR CUSTOM (-99)

MASTER BALL WASHER



- PAR205-01 PAR AIDE RED
- PAR205-02 HUNTER GREEN
- PAR205-00 BLACK
- PAR205-99 SPECIFY COLOR

DELUXE BALL WASHER



- PAR203-01 PAR AIDE RED
- PAR203-02 HUNTER GREEN
- PAR203-00 BLACK
- PAR203-99 SPECIFY COLOR

DELUXE BALL WASHER ENSEMBLE



- PAR30-** DELUXE ENSEMBLE (NO TRASH)
- PAR31-** DELUXE ENSEMBLE W/ SINGLE TRASH MATE
- PAR34-** DELUXE ENSEMBLE W/ DOUBLE TRASH, SPIKE BRUSH & CLUB WASHER

**CHOOSE COLORS RED (-01), GREEN (-02), BLACK (-00) OR CUSTOM (-99)





PAR AIDE BALL WASHER PARTS FOR DELUXE & MASTER BALL WASHERS



BALL WASHER PARTS

| | |
|--------------|-------------------------------|
| PAR200-10 | BALL WASHER REPAIR KIT |
| PAR200-30 | AGITATOR ASSEMBLY |
| PAR200-31 | AGITATOR TOP KNOB ONLY |
| PAR200-21-4 | CAP SCREW |
| PAR203-25 | FOAM GASKET (DELUXE) |
| PAR205-25 | FOAM GASKET (MASTER) |
| PAR203-70-6 | COVER LOCKING SCREW |
| PAR200-20 | BRUSH ASSEMBLY |
| PAR200-60-4 | TOWEL CLIP (PACK OF 4) |
| PAR203-40-4 | DRAIN PLUG (PACK OF 4) |
| PAR203-50-10 | DRAIN GASKET (PACK OF 10) |
| PAR200-80-4 | AGITATOR LOCK NUT (PACK OF 4) |
| PAR204-70-6 | BASE LOCK SCREW (PACK OF 6) |
| PAR200-11-4 | AGITATOR GROMMET (PACK OF 4) |
| PAR203-10-4 | DRAIN PLUG WRENCH (PACK OF 4) |
| PAR203-16-4 | ALLEN WRENCH (PACK OF 4) |



BALL WASHER BODY & COVERS

| | |
|------------|-----------------------------|
| PAR1203-00 | DELUXE BODY - BLACK |
| PAR1203-01 | DELUXE BODY - RED |
| PAR1203-02 | DELUXE BODY - HUNTER GREEN |
| PAR1205-02 | MASTER BODY - HUNTER GREEN |
| PAR2203-00 | DELUXE COVER - BLACK |
| PAR2203-01 | DELUXE COVER - RED |
| PAR2203-02 | DELUXE COVER - HUNTER GREEN |
| PAR2203-99 | DELUXE COVER - CUSTOM COLOR |
| PAR2205-00 | MASTER COVER - BLACK |
| PAR2205-01 | MASTER COVER - RED |
| PAR2205-02 | MASTER COVER - HUNTER GREEN |

BALL WASHER REPAIR KIT

Par Aide

BALLWASHER REPAIR KIT INCLUDES:

- Agitator assembly
- Cap screw
- Foam gasket
- Cover locking screw
- Brush assembly
- Towel clip
- Drain plug
- Drain gasket



PAR200-10

MOUNTING PIPE

- Aluminum pipe will not rust
- Powder coated finish
- 2.75 inch outside diameter
- 40 inch post for permanent mounting in the ground or in concrete
- Multiple posts for use with portable base

| | |
|-----------|-------------|
| PAR209-00 | BLACK - 12" |
| PAR210-00 | BLACK - 34" |
| PAR210-02 | GREEN - 34" |
| PAR211-00 | BLACK - 48" |
| PAR211-02 | GREEN - 48" |
| PAR212-00 | BLACK - 24" |

BALL WASHER BRACKET

Mount Ball Washer to Flat Surface



PAR215-00

PORTABLE BASE



| | |
|-----------|--------------|
| PAR310-01 | PAR AIDE RED |
| PAR310-02 | HUNTER GREEN |
| PAR310-00 | BLACK |

SINGLE PIPE MOUNT SPIKE BRUSH



PAR552-11

CLASSIC BALL WASHER



- Crank-style washer with four-ball capacity
- Free engraving on orders of 9 or more when using the same logo



| | |
|----------|--------|
| STD01325 | RED |
| STD01350 | GREEN |
| STD01370 | BLACK |
| STD01300 | YELLOW |
| STD01340 | BROWN |
| STD01375 | BLUE |
| STD01395 | WHITE |

Pricing is subject to change.

FLOOR MOUNT SPIKE CLEANER



- PAR549-11** SPIKE & SHOE CLEANER
- PAR554-11** REPLACEMENT BOTTOM BRUSH
- PAR548** REPLACEMENT SIDE BRUSH

SCRUSHER



- STD14100** SCRUSHER
- STD14102** REPLACEMENT BOTTOM BRUSH
- STD14103** REPLACEMENT SIDE BRUSH

SPIKE KLEENER



- STD14750** BLACK
- STD14252** REPLACEMENT BRUSH

TRASH MATE CONTAINERS AND PARTS

- PAR3014-00** CONTAINER ONLY - BLACK
- PAR3014-01** CONTAINER ONLY - RED
- PAR3014-02** CONTAINER ONLY - GREEN
- PAR3014-03** CONTAINER ONLY - BLUE
- PAR3010** LID ONLY - "CANS ONLY"
- PAR3011** LID ONLY - TRASH
- PAR3012** LID ONLY - SOLID
- PAR3005-00** TRASH MATE W/ MOUNT- BLACK
- PAR3005-01** TRASH MATE W/ MOUNT - RED
- PAR3005-02** TRASH MATE W/ MOUNT - GREEN
- PAR3005-03** TRASH MATE W/ MOUNT - BLUE
- PAR3030** TRASH MATE LOW STAND
- PAR3031** TRASH MATE IN GROUND STAND



9 GALLON TAPERED LITTER CADDIE



- STD13400** YELLOW WITH SPIKE
- STD13150** RED WITH SPIKE
- STD13152** RED WITH BASE
- STD13700** GREEN WITH SPIKE
- STD13800** GREEN WITH BASE
- STD13175** BLUE WITH SPIKE
- STD13177** BLUE WITH BASE
- STD13195** BLACK WITH SPIKE
- STD13197** BLACK WITH BASE
- STD13199** CUSTOM LOGO

30 GALLON TAPERED LITTER CADDIE

- STD13050** RED WITH SPIKE
- STD13053** RED WITH BASE
- STD13075** GREEN WITH SPIKE
- STD13078** GREEN WITH BASE
- STD13080** BLUE WITH SPIKE
- STD13083** BLUE WITH BASE
- STD13095** BLACK WITH SPIKE
- STD13098** BLACK WITH BASE



*20 gallon option available. See page 54 for little caddie liners and cover options.

MICROFIBER TEE TOWELS

18"H x 6"W Tri-Fold

- Seven times the absorbency and three times the wicking power of cotton.
- Stain-, odor- and UV-resistant.
- Microfiber stays cleaner longer, dries faster, requires less maintenance.
- You can embroider them with your club logo.
- Priced per dozen



- STD04500** BLACK
- STD04503** GREEN
- STD04290** ADD LOGO EMBROIDERY
- STD20990** LOGO TAPE SET-UP CHARGE

PREMIUM VELOUR TEE TOWELS

Tri-Fold Or Corner Grommet

- Ultra premium velour
- 16" X 26"
- Includes hanging clip
- Longer size great for adding logo



- GCATT-BK** BLACK
- GCATT-GR** GREEN
- GCATT-BR** BROWN
- GCATT-NB** NAVY BLUE
- GCATT-WH** WHITE
- GCATT-RD** RED
- GCATT-BU** BURGUNDY

TERRY VELOUR TEE TOWELS

UV Sunlight Resistant

- Great value!
- 15" X 18"
- Includes hanging clip
- Choose from black or green
- Tri-fold or corner grommet
- Uv resistance lasts 3-4 times longer than regular towel
- Pack of 12



GCATTUV

NOTE FOR PREMIUM AND TERRY TEE TOWELS
Use -TRI for Tri-fold or -COR for corner grommet at the end of part # (EXAMPLE- GCATT-RD-TRI or -COR)

PREMIUM DISPOSABLE TEE TOWELS



\$195.00

- GCATTG** GREEN (CASE OF 200)
- GCATTB** BLACK (CASE OF 200)

COTTON TEE TOWELS

Tri-Fold



- PAR403** GREEN (DOZEN) \$63.00
- PAR404** GREEN 12 DOZEN (CASE) \$756.00
- PAR405** BLACK (DOZEN) \$69.00
- PAR406** BLACK 12 DOZEN (CASE) \$828.00

GREEN COTTON TEE TOWELS

Corner Grommet



- PAR403-2** PER DOZEN \$63.00
- PAR404-2** 12 DOZEN (CASE) \$756.00

VALUE TEE TOWELS



- Microfiber constructed towel.
- Machine washable.
- Priced per dozen

- STD04511** BLACK
- STD04510** GREEN

ECONOMY DISPOSABLE TEE TOWELS



STD04969 CASE OF 200 GREEN & WHITE

TOWEL CLIP



PAR200-60-4 4-PACK

PAR AIDE BALL WASHER DETERGENT

Lemon Scented



- PAR4102** 5 LB. CARTON TABLETS
- PAR4110** 1 GAL LIQUID
- PAR4112** 4 GAL CASE
- PAR4103** CASE OF 4 CARTON TABLETS

SPARKLEEN LIQUID SOAP

Case Of (4) 1 Gallon Jugs



STD03300

SPARKLEEN ECOMAX TABLETS

450 Count Jar



STD03100

Pricing is subject to change.

COLOR OPTION KEY



GREEN BROWN BLACK WALNUT GREY

Call us for more color, logo, & caster options

LOGO OPTION KEY



LEXAN ENGRAVED CAST BRONZE CAST ALUMINUM

RECYCLED LUMBER DIVOT MIX BOTTLE RACK

Holds 24 Bottles



NO HANDLE SLOTS SLOTS FOR HANDLE

- | | | |
|--------------|-------------|--------------|
| HUNTER GREEN | RCPDBR24-GN | RCPDBR24H-GN |
| BROWN | RCPDBR24-BR | RCPDBR24H-BR |
| BLACK | RCPDBR24-BK | RCPDBR24H-BK |

Call us for availability for portable option with feet

DOUBLE DIVOT MIX BOTTLE HOLDER

Holds 30 Bottles



- | | |
|--------------|-------|
| RCPDMBH-D-GN | GREEN |
| RCPDMBH-D-BK | BLACK |
| RCPDMBH-D-BR | BROWN |

DOUBLE DECK DIVOT MIX BOTTLE HOLDER

Holds 30 Bottles



- | | |
|---------------|-------|
| RCPDMBH-DD-GN | GREEN |
| RCPDMBH-DD-BK | BLACK |
| RCPDMBH-DD-BR | BROWN |

PREMIUM BOTTLE STORAGE BOX

30" L x 32" W x 23" H



- | | |
|-------------|---------------------|
| RCPDBB25-GN | HUNTER GREEN |
| RCPDBB25-BR | BROWN |
| RCPDBB25-BK | BLACK |
| RCPDBB25-BB | BLACK W/ BROWN TRIM |
| RCPDBB25-GB | GREEN W/ BLACK TRIM |

SINGLE DIVOT MIX BOTTLE HOLDER

Holds 15 Bottles



- | | |
|--------------|-------|
| RCPDMBH-S-GN | GREEN |
| RCPDMBH-S-BK | BLACK |
| RCPDMBH-S-BR | BROWN |

RAISED & PORTABLE DIVOT MIX BOX

Holds 24 Bottles



- | | |
|--------------|-------|
| RCPDMB-RP-GN | GREEN |
| RCPDMB-RP-BK | BLACK |
| RCPDMB-RP-BR | BROWN |

SMALL DIVOT BOTTLE BOX

Holds 12 Bottles



- | | |
|--------------|-------|
| RCPDBB-SM-GN | GREEN |
| RCPDBB-SM-BK | BLACK |
| RCPDBB-SM-BR | BROWN |

SMALL DIVOT BOTTLE CADDIE

Holds 12 Bottles



- | | |
|--------------|-------|
| RCPDBC-SM-GN | GREEN |
| RCPDBC-SM-BK | BLACK |
| RCPDBC-SM-BR | BROWN |

DIVOT BOTTLE FAIRWAY CADDIE

Laser Cut Metal



- | | |
|-----------|-------|
| DRESBH-BK | BLACK |
| DRESBH-GN | GREEN |

TEE SEED & SOIL CADDIE

With Holder



- | | |
|----------|--------------|
| STD18800 | BLACK |
| STD18900 | HUNTER GREEN |



COLOR OPTION KEY



GREEN BROWN BLACK WALNUT GREY

Call us for more color & logo options

LOGO OPTION KEY



LEXAN

ENGRAVED

CAST BRONZE

CAST ALUMINUM

XL DIVOT MIX SAND & SEED STORAGE BOX

19" L x 21" W x 28" H



- RCPDMB-XL-GN GREEN
- RCPDMB-XL-BK BLACK
- RCPDMB-XL-BR BROWN

ANGLE RAISED MIX STORAGE BOX

22" L x 15" W x 27" H



- RCPDMC-RAS-GN GREEN
- RCPDMC-RAS-BK BLACK
- RCPDMC-RAS-BR BROWN

SQUARE DIVOT MIX CONTAINER

5 Gallon
12" L x 18" W x 12" H



- RCPDCS5-GN GREEN
- RCPDCS5-BK BLACK
- RCPDCS5-BR BROWN
- RCPDCS5-BB BLACK W/ BROWN TRIM
- RCPDCS5-GB GREEN W/ BLACK TRIM

150 GALLON BULK DIVOT MIX SAND & SEED CONTAINER

26" L x 41" W x 33" H



- RCPDMB-LG-GN GREEN
- RCPDMB-LG-BK BLACK
- RCPDMB-LG-BR BROWN

ROUND DIVOT MIX CONTAINER

10 Gallon - 20" L x 20" W x 22" H



- RCPDMC-SR10-GN GREEN
- RCPDMC-SR10-BK BLACK
- RCPDMC-SR10-BR BROWN

DIVOT PRO JUNIOR

5 Gallon
29" L x 18" W x 35" H



- PAR3420 HUNTER GREEN
- PAR3421 BLACK
- PAR3422 REDWOOD
- PAR3423 CAMEL

DIVOT MATE WITH LOW STAND



- PAR435-00 BLACK
- PAR435-02 HUNTER GREEN
- PAR3030 STAND ONLY

SEED & SOIL BUTLER



STD18970

QUAD SOIL CADDIE

Holds 4 Bottles



STD18890

ROUND DIVOT MIX CONTAINER

3.5 Gallon - 29" L x 18" W x 35" H
5 Gallon - 14" L x 14" W x 17" H



- RCPDCR3.5-GN 3.5 GAL - GREEN
- RCPDCR3.5-BK 3.5 GAL - BLACK
- RCPDCR3.5-BR 3.5 GAL - BROWN
- RCPDCR5-GN 5 GAL - GREEN
- RCPDCR5-BK 5 GAL - BLACK
- RCPDCR5-BR 5 GAL - BROWN

PLASTIC & ALUMINUM SCOOPS

- PAR400 8 OZ PLASTIC
- PAR456 16 OZ PLASTIC
- GCAAS12 12 OZ ALUMINUM
- DRESS 12 OZ BLACK SAND SCOOP



Pricing is subject to change.

DIVOT BOTTLES

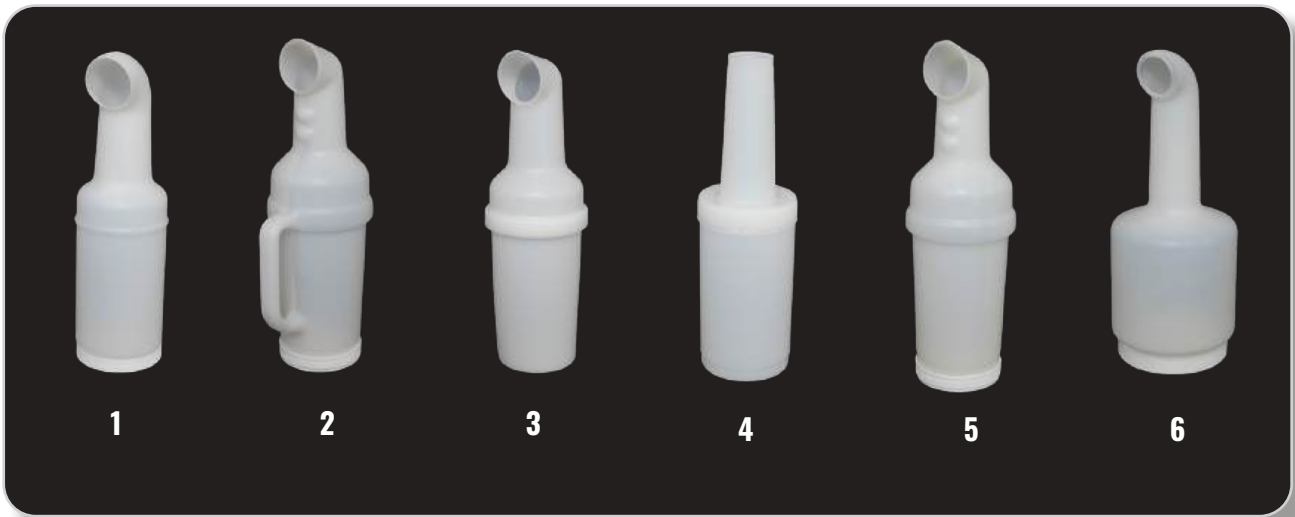

1 - BOTTOM-FILL CURVE NECK
CAPACITY 45 OZ.

DRESB100

2 - HANDLE GRIP BOTTLE
BOTTOM-FILL CURVED NECK
CAPACITY 45 OZ.

DRESB800

3 - TOP-FILL CURVE NECK
CAPACITY 35 OZ.

DRESB650

4 - TOP-FILL STRAIGHT NECK
CAPACITY 32 OZ.

DRESB150

5 - NEW RATTLE-PROOF CAP
BOTTOM-FILL CURVE/GRIP NECK -
CAPACITY 45 OZ.

DRESB750

6 - OVERSIZE BOTTLE
BOTTOM-FILL CURVED NECK
LARGE CAPACITY 78 OZ.

STD18802

REPLACEMENT CAPS

For Sand Bottles Above



FLAT STYLE

RATTLE PROOF

DRECAP555 BOTTOM FILL - FLAT CAP

DRECAP554 BOTTOM FILL - RATTLE PROOF CAP

KADDIE KLIP

Walking Divot Bottle



- Introducing Kaddie Klip - a lightweight solution that simply clips anywhere
- No assembly or mounting required
- Easily stores 16 ounces of anything you choose including 7 golf balls or sand/seed mix
- Each 13 inch Kaddie Klip is water-tight and constructed of durable plastic
- Made for walkers to carry sand while they golf



DRECC100

TEE SEED & SOIL CADDIE

With Holder



- Contoured bottle keeps mixture dry
- Steel powder-coated holder included
- Includes decal and 78 oz (2.3 L) bottle with screw-on cap
- Available in two colors – Hunter Green and Black

STD18800 BLACK

STD18900 GREEN

DIVOT BOTTLE FAIRWAY CADDIE

Laser Cut Metal



- Laser cut metal w/ spike easily goes into the ground
- For bottles order **DRESB750**

DRESBH-BK BLACK

DRESBH-GN GREEN

UNIVERSAL HOLDER KIT

Includes Mounting Bracket



DREHO500 HOLDER ONLY

DREHO501 HOLDER ONLY SLOTTED

SOLID COLOR FLAGS



PW14X20PL

CHECKERED FLAGS

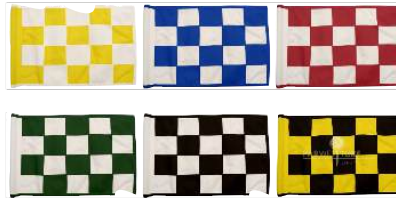

PW14X20CK

DIAGONAL FLAGS

Minimum 9 Flags Per Order



PW14X20DGPL



DIAGONAL NUMBERED FLAGS

Minimum 9 Flags Per Order



PW14X20DNS
REGULATION SINGLE NUMBER

PW14X20DND
REGULATION DOUBLE NUMBER

NUMBERED FLAGS

Minimum 9 Flags Per Order



PW14X20N

TUBE STYLES

Hard Tubes

- Flag sits on flagstick with a hard, plastic internal tube.

Soft Tubes

- Flag sits on flagstick with a soft, nylon inner tube and grommet on top.

Grommets

- Flag connects to flagstick using 3 grommets (no tube). Requires swivel adapter on flagstick.

DIRT GUARDS

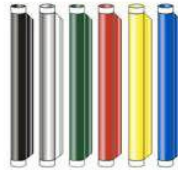

- Keep your flags looking new
- Six colors available
- Polyethylene cover fits securely over tube for a long-lasting, clean look!

PWGD PLASTIC DIRT GUARD \$3.25

BORDERS & FABRIC SLEEVES



BORDER & FABRIC SLEEVE



BORDER ONLY



FABRIC SLEEVE ONLY



CUSTOM LOGO REGULATION GOLF FLAGS

SINGLE SIDED SCREEN PRINTED
Regulation



PW14X20SP

Up to 6 colors
Minimum 9 flags per order
Logo on front side only

DOUBLE SIDED SCREEN PRINTED
Regulation



PW14X20SPD

Up to 6 colors
Minimum 9 flags per order
Logo reads correct on both sides

EMBROIDERED LOGO FLAGS
Regulation



SINGLE SIDED PW14X20ESS

DOUBLE SIDED PW14X20EDS

Up to 6 colors
Minimum 9 flags per order
Single sided reads reverse on back
Double-sided reads correctly on both sides



- All flags made of 400 denier nylon for the highest quality and longest life. Call one of our experienced reps to further customize the shape, borders or mounting style of your flag.
- Our in house artists will help you create your design and convert your logo into a vector file for printing
- Art set-up fees may apply on new orders. Extra charge for screen print (waived with 27 or more flags) and extra charge for embroidered flag (waived with 36 or more flags)



CHECK SCREEN PRINTED FLAGS
Double Sided



PW14X20CKSP

Up to 6 colors
Minimum 9 flags per order
Logo reads correct on both sides

CHECKERED EMBROIDERED FLAGS



SINGLE SIDED PW14X20CKES

DOUBLE SIDED PW14X20CKEDS

Up to 6 colors
Minimum 9 flags per order
Single sided reads reverse on back
Double-sided reads correctly on both sides

DIAGONAL LOGO FLAGS
Single Or Double-Sided



SINGLE SIDED PW14X20DGE

DOUBLE SIDED PW14X20DGED

Up to 6 colors
Minimum 9 flags per order
Single sided reads reverse on back
Double-sided reads correctly on both sides
Available in embroidery or screen print



SPECIAL LENGTH FLAGSTICKS

5, 10, 12 Foot Tall

- Longer flagsticks used to improve visibility on holes with hills
- Choose 5 foot, 10 foot or 12 foot tall
- 2 piece for reduced shipping costs - easily glues together and holds tight
- Available in white, yellow or black/white stripe
- custom colors available - please call 714-893-1555

| PART # | DESCRIPTION | DIAMETER |
|--------------|---------------------------------------|----------|
| PWFS5-YW | 5 FOOT POLE - YELLOW | 1/2" |
| PWFS5-WH | 5 FOOT POLE - WHITE | 1/2" |
| PWFS5-RD | 5 FOOT POLE - RED | 1/2" |
| PWFS5-RB | 5 FOOT POLE - ROYAL BLUE | 1/2" |
| PWFS5-PK | 5 FOOT POLE - PINK | 1/2" |
| PWFS5-OR | 5 FOOT POLE - ORANGE | 1/2" |
| PWFS5-KG | 5 FOOT POLE - KELLY GREEN | 1/2" |
| PWFS5-BK | 5 FOOT POLE - BLACK | 1/2" |
| PWFS5-CUSTOM | 5 FOOT POLE - CUSTOM COLOR | 1/2" |
| PWFS10-WH | 10 FOOT POLE - WHITE | 1/2" |
| PWFS10-YW | 10 FOOT POLE - YELLOW | 1/2" |
| PWFS10-BW | 10 FOOT POLE BLACK/WHITE STRIPE | 1/2" |
| PWFS12-WH | 12 FOOT POLE - WHITE | 1/2" |
| PWFS12-YW | 12 FOOT POLE - YELLOW | 1/2" |
| PWFS12-BW | 12 FOOT POLE BLACK/WHITE STRIPE | 1/2" |
| PWFS10T-WH | 10 FOOT TAPERED - WHITE | 3/4" |
| PWFS10T-YW | 10 FOOT TAPERED - YELLOW | 3/4" |
| PWFS10T-BW | 10 FOOT TAPERED BLACK/WHITE STRIPE | 3/4" |
| PWFS12T-WH | 12 FOOT TAPERED - WHITE | 3/4" |
| PWFS12T-YW | 12 FOOT TAPERED - YELLOW | 3/4" |
| PWFS12T-BW | 12 FOOT TAPERED BLACK/WHITE STRIPE | 3/4" |



**IPE HARDWOOD
REGULATION FLAGSTICKS**

When You Want to Add the Extra Touch

- Made of high quality ipe hard wood
- 1/2" Black fiberglass top and bottom
- Aluminum grooved ferrule



PWFSW7.5 FLAGSTICK W/ FIBERGLASS FITTING

PWFSW7.5-B FLAGSTICK W/ BRASS FITTING



5', 10' OR 12' POLES WITH 6 PRISM REFLECTORS

- Long Smartsticks
- A discrete and effective solution for gauging distance using a rangefinder.
- Prism Inserts come in black, white, or yellow
- Ferrules: Aluminum smooth, grooved ferrules or stainless steel grooved
- All poles two piece for less shipping costs

| | | |
|--------------|---------------------------------------|------|
| PWFS10LL-YW | 10 FOOT PRISM POLE, YELLOW | 1/2" |
| PWFS10LL-WH | 10 FOOT PRISM POLE, WHITE | 1/2" |
| PWFS12LL-YW | 12 FOOT PRISM POLE, YELLOW | 1/2" |
| PWFS12LL-WH | 12 FOOT PRISM POLE, WHITE | 1/2" |
| PWFS10TLL-YW | 10 FOOT TOURNAMENT PRISM POLE, YELLOW | 3/4" |
| PWFS10TLL-WH | 10 FOOT TOURNAMENT PRISM POLE, WHITE | 3/4" |
| PWFS12TLL-YW | 12 FOOT TOURNAMENT PRISM POLE, YELLOW | 3/4" |
| PWFS12TLL-WH | 12 FOOT TOURNAMENT PRISM POLE, WHITE | 3/4" |

Pricing is subject to change.

REGULATION FLAGSTICKS 7.5'

Par Aide

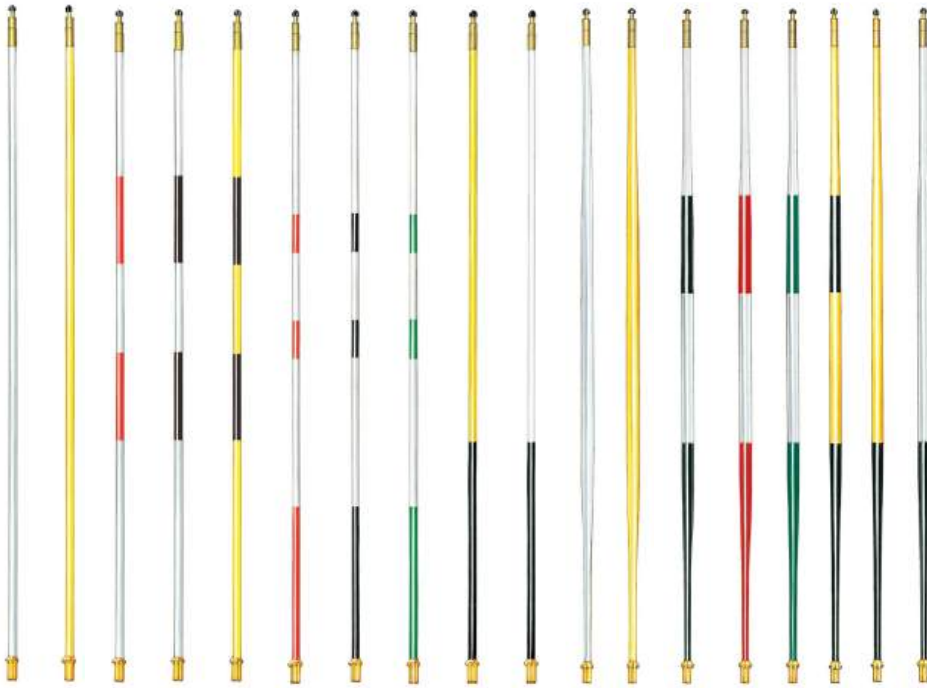

| PART # | STYLE - SOLD IN BOX OF 9 |
|-------------|---|
| PAR740-0759 | YELLOW 1/2" |
| PAR730-0759 | WHITE 1/2" |
| PAR725-0759 | 2 STRIPE RED & WHITE 1/2" |
| PAR727-0759 | 2 STRIPE RED & WHITE 1/2" |
| PAR752-0759 | 2 STRIPE BLACK & WHITE 1/2" |
| PAR747-0759 | 2 STRIPE YELLOW & BLACK 1/2" |
| PAR720-0759 | 3 STRIPE RED & WHITE 1/2" |
| PAR750-0759 | 3 STRIPE BLACK & WHITE 1/2" |
| PAR755-0759 | 3 STRIPE GREEN & WHITE 1/2" |
| PAR745-0759 | YELLOW WITH 30 IN. BLACK BOTTOM 1/2" |
| PAR754-0759 | WHITE WITH 30 IN. BLACK BOTTOM 1/2" |
| PAR706-079 | WHITE TOURNAMENT 3/4" |
| PAR707-079 | YELLOW TOURNAMENT 3/4" |
| PAR708-079 | BRITISH BLACK & WHITE STRIPE TOURNAMENT 3/4" |
| PAR712-079 | BRITISH RED & WHITE STRIPE TOURNAMENT 3/4" |
| PAR713-079 | BRITISH GREEN & WHITE STRIPE TOURNAMENT 3/4" |
| PAR714-079 | BRITISH BLACK & YELLOW STRIPE TOURNAMENT 3/4" |
| PAR716-079 | BRITISH BLUE & WHITE STRIPE TOURNAMENT 3/4" |
| PAR709-079 | YELLOW WITH 30 IN. BLACK BOTTOM TOURNAMENT 3/4" |
| PAR711-079 | WHITE WITH 30 IN. BLACK BOTTOM TOURNAMENT 3/4" |



Par aide's exclusive patented ferrule design eliminates 66% of the friction and allows sand and soil to pass through, which eliminates sticking. The precise taper of the ferrule keeps the flagsticks standing straight with less wobble. Matched with a Par Aide cup, it's an unbeatable combination.

**Par Aide
FLAGSTICK PARTS**



| PART # | DESCRIPTION |
|------------|-------------------------------------|
| PAR1732-6 | TOP STUD -PACK OF 6 |
| PAR1729-6 | FERRULE- PACK OF 6 |
| PAR1733-6 | ACORN NUT- PACK OF 6 |
| PAR1740-10 | QUICK RELEASE TOP STUD - PACK OF 10 |

PINSITE REFLECTORS

Par Aide

- Nylon threaded PinSite Reflector – will not seize to top of flag stick
- Use with all laser golf distance measuring devices (including: Bushnell, Laser Link, Leupold, Nikon, Callaway, etc.)
- Premium glass prisms for maximum accuracy



PAR1736

1" ALUMINUM / FIBERGLASS FLAGSTICKS

Par Aide



A full 8 ft. (2.44 M) tall, this lightweight exclusive par aide design meets usga regulations. Top and bottom shanks are 1/2 in. (1.3 Cm) diameter, color-impregnated fiberglass in bright yellow, bright white, black and red for ultimate visibility. The powder-coated, 1 in. (2.5 Cm) diameter aluminum body allows for a completely custom look.



| | |
|-------------------|-------------------------------------|
| PART # | STYLE - SOLD IN BOX OF 9 |
| PAR701-089 | YELLOW 1/2" |
| PAR702-089 | WHITE 1/2" |
| PAR703-089 | WHITE W/ BLACK BOTTOM STRIPE |
| PAR704-089 | WHITE W/ 2 BLACK STRIPES |
| PAR705-089 | WHITE W/ 3 BLACK STRIPES |

PRISM FLAGSTICKS

Par Aide



| | |
|----------------------|--|
| PART # | SOLD IN BOX OF 9 FLAGSTICKS |
| PAR740-0759-1 | YELLOW 1/2" |
| PAR730-0759-1 | WHITE 1/2" |
| PAR750-0759-1 | 3 STRIPE BLACK & WHITE 1/2" |
| PAR745-0759-1 | YELLOW W/ 30" BLACK BOTTOM 1/2" |
| PAR706-079-1 | TAPERED WHITE 3/4" |
| PAR707-079-1 | TAPERED YELLOW 3/4" |
| PAR708-079-1 | TAPERED BLACK & WHITE STRIPE 3/4" |

SKINNY FLAGSTICK

Par Aide



- Constructed with 3/8 in. fiberglass from the ferrule to the fitting (10 in.), Transitioning seamlessly to the traditional 1/2 in. diameter
- Available in 3 popular color and striping patterns to suit any course style
- Smaller diameter allows more room when removing the ball with the flagstick in, reducing or eliminating cup damage



| | |
|----------------------|--|
| PART # | SOLD IN BOX OF 9 FLAGSTICKS |
| PAR740-0759-3 | YELLOW 1/2" |
| PAR730-0759-3 | WHITE 1/2" |
| PAR752-0759-3 | 2 STRIPE BLACK & WHITE 1/2" |

VINYLSHIELD FLAGPOLE RESTORATION

VinylShield by Par West



An economical and easy way to re-new and protect splintered, cracked, faded, scratched, or dirty poles. Quickly applies with heat gun and will last for years. Fits tournament and regulation poles.

| | |
|------------------|---------------------------------------|
| VSFS12-YW | YELLOW 250' ROLL FOR 1/2" POLE |
| VSFS12-WH | WHITE 250' ROLL FOR 1/2" POLE |
| VSFS34-YW | YELLOW 250' ROLL FOR 3/4" POLE |
| VSFS34-WH | WHITE 250' ROLL FOR 3/4" POLE |

Pricing is subject to change.

SMARTY SIX
Screw-On Reflectors



- Screws on any flagstick to convert to laser link
- Reflectors are oriented to provide 360° reflectivity.
- Black Smarty 6 available with metal or nylon threads.
- Comes in black or red hot color options

| | |
|------------------|---------------------------------|
| GCASM6-B | BLACK - BRASS THREAD |
| GCASM6-P | BLACK - PLASTIC THREAD |
| GCASM6R-B | RED HOT - BRASS THREAD |
| GCASM6R-P | RED HOT - PLASTIC THREAD |

LASER REFLECTORS

Slide Over Reflectors - Set of 9



- Full 360° visibility, no dead spots, made of highly reflective material with a large surface area.
- Comes with Grommets to hold on flagstick
- Made for both 1/2" and 3/4" poles. Sold in sets of 9.

| | |
|----------------|---------------------|
| GCALR12 | 1/2" OPENING |
| GCALR34 | 3/4" OPENING |

HIGH TEMPERATURE HEAT GUN

Use To Shrink VinylShield Tubing



- Economical, multi-purpose heat gun
- Heavy duty air blower provides rapid shrinking

VSVT-HG

STANDARD GOLF ROYALINE 1/2" REGULATION FLAGSTICKS 7.5'

1/2" Diameter From Top To Bottom

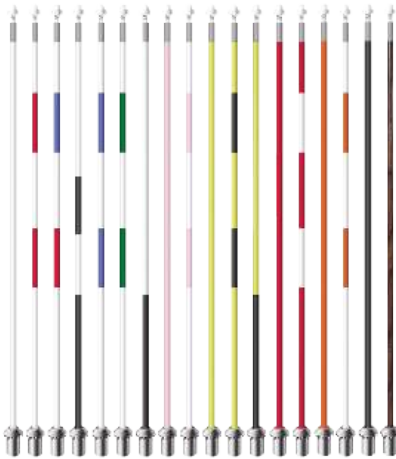

| PART # | | PART # | |
|----------|----------------------------|----------|------------|
| STD26101 | WHITE/RED STRIPE | STD26100 | WHITE |
| STD26102 | WHITE/BLUE/RED STRIPE | STD26107 | PINK |
| STD26103 | WHITE/BLACK BRITISH STRIPE | STD26110 | YELLOW |
| STD26104 | WHITE/BLUE STRIPE | STD26114 | ORANGE |
| STD26105 | WHITE/GREEN STRIPE | STD26120 | RED |
| STD26106 | WHITE/30" BLACK BOTTOM | STD26130 | BLACK |
| STD26108 | WHITE/PINK STRIPE | STD26134 | WOOD GRAIN |
| STD26111 | YELLOW/BLACK STRIPE | | |
| STD26112 | YELLOW/30" BLACK BOTTOM | | |
| STD26115 | WHITE /ORANGE STRIPE | | |
| STD26121 | RED/WHITE STRIPE | | |



STANDARD GOLF ROYALINE 3/4" TOURNAMENT FLAGSTICKS 7.5'

1/2" Diameter At Both Tip And Ferrule 3/4" Diameter At The Center

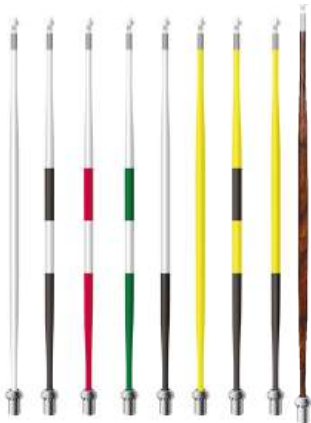

| PART # | | PART # | |
|----------|-----------------------------|----------|------------|
| STD26301 | WHITE/BLACK BRITISH STRIPE | STD26300 | WHITE |
| STD26302 | WHITE/RED BRITISH STRIPE | STD26310 | YELLOW |
| STD26303 | WHITE/GREEN BRITISH STRIPE | STD26315 | WOOD GRAIN |
| STD26304 | WHITE W/ 30" BLACK BOTTOM | | |
| STD26306 | WHITE W/ 4 BLACK STRIPES | | |
| STD26311 | YELLOW/BLACK BRITISH STRIPE | | |
| STD26314 | YELLOW W/ 30" BLACK BOTTOM | | |



NEW PRODUCT!



STANDARD GOLF LASER TOURNAMENT FLAGSTICKS 7.5'

Embedded Prism Laser Reflectors

| PART # | |
|----------|----------------------------|
| STD26316 | WHITE |
| STD26317 | YELLOW |
| STD26318 | WHITE/BLACK BRITISH STRIPE |
| STD26319 | WOOD GRAIN |

All flagsticks are made of fiberglass and come standard with the Smart-Fit™ 360 ferrule unless otherwise specified. All Royale Flagsticks are veil-wrapped to prevent splintering and protect color.



LASER REFLECTOR

Flagstick Top Reflectors

- Easily replaces acorn nut on Standard, Par Aide, and all other flagsticks with 3/8-24 threaded tip.
- Features nylon threads. No more metal-on-metal seizing associated with brass inserts.
- New five-glass prism pod design maximizes reflectivity, leaving no dead spots.
- Prisms snap into place for extra durability.



STD26600

FERRULES

Standard Golf



STD26517 TRADITIONAL

NEW PRODUCT!



STD26515 SMART FIT 360

**RED / WHITE / BLUE
FLAGSTICKS**



Our 7.5' Flagstick with red, white and blue stripes to go with the american flag.

Flags sold separately

PWFSS7.5-RWB

U.S. PIN FLAGS



DIGITAL PRINT

PW6X8DPUS PRACTICE GREEN

PW14X20DPUS REGULATION

EMBROIDERED

PW14X20USEMB REGULATION

U.S. FLAG DECALS

Use With 935 Liners



NHUSFLG SET OF 36 DECALS

CUSTOM DECALS

- Add your course logo or celebrate events with a custom decal on your liner or cup
- Free art work

GREENS CADDIE FLAG SAVER STAND & SIGN

Keep Special Event Flags Off the Ground



- Our greens caddie keeps flags off of the ground
- 30 Inches tall
- Recycled lumber material never needs painting - no fading or chipping
- Available in black, green or white

GCAGC-GN GREEN

GCAGC-BK BLACK

GCAGC-WH WHITE

PWALS12X12-120S FLAG SIGN WITH POST



PAR520-1 (MINIMUM 36)

FLAGSTICK CADDIE

Hold Up To 18 Flagsticks

STD25000 1- FLAGSTICK CADDIE (2-PIECE) - HOLDS 18 FLAGSTICKS

STD25100 2- JR. FLAGSTICK CADDIE (2-PIECE) - HOLDS 6 FLAGSTICKS

STD25001 3- ALTERNATIVE BRACKET (2-PIECE)

STD25002 4- REPLACEMENT FLAGSTICK HOLDER



Pricing is subject to change.



EVER-WHITE CUPS



- The patented ever-white cup has revolutionized the putting cup by teaming an aluminum outside with a replaceable bright white plastic sleeve
- No paint to chip, no need to strip and re-powdercoat
- Cups can easily stay white all season long by replacing sleeves every time they get dirty
- Still get the classic sound of a ball dropping into an aluminum cup
- Replacement liners come in a box of 18
- Pink liners available for special tournaments
- Custom decals to add even more detail to your cups or even to sell advertising on for a fundraising tournament

PAR935 EVER-WHITE CUP

PAR935-1 LINERS (CASE OF 18)

PAR935-4 PINK LINERS



6" ALUMINUM REGULATION CUPS



- Our classic & best selling model
- It's die cast oversize, then machined down to precision dimensions to minimize wobble in the hole
- Powder coated so no paint to chip
- Meets all USGA regulations
- also available in pink for special tournaments
- Pga tournament version also available - call for details

PAR930 WHITE

PAR930-99 PINK



6" ZINC REGULATION CUPS

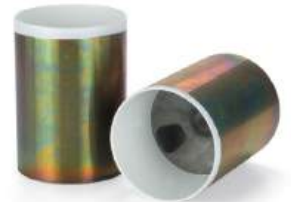

PAR937



6" PLASTIC REGULATION CUPS



PAR920

EIGHT INCH WHITE CUP
8" Plastic



PAR925 \$21.00

EIGHT INCH HOLE CUTTER/ADAPTER



PAR1005 8" HOLE CUTTER

PAR1012 8" HOLE CUTTER ADAPTER



EDGE SAVER



PAR1725 PACK OF 10





SMART-FIT CUPS
Standard Golf STD2000



- Notched-ferrule flagsticks fall right into place every time without twisting, sticking or sinking.
- Bonderite aluminum cups for maximum life and the most chip-resistant coating around.
- High strength plastic cups molded with chemical-resistant polymers provide a brilliant, lasting finish.
- Hybrid cup is an aluminum base cup with plastic over-molded sides.
- Meets all USGA regulations

- STD18333** ALUMINUM
- STD18222** PLASTIC
- STD18333P** ALUMINUM - PINK
- STD18444** HYBRID



ALUMINUM



PLASTIC



HYBRID



4" & 6" PLASTIC REGULATION CUPS
Riji Cup



- STD18200** 6" WHITE
- STD18100** 4" WHITE



4" & 6" ALUMINUM REGULATION CUPS



- STD18303** 6" WHITE
- STD18303P** 6" PINK
- STD18150** 4" WHITE



SPECIAL EVENT CUPS
6" Steel



- STD18600** WHITE
- STD18600P** PINK



SPECIAL EVENT CUPS
8" Steel



- STD18700** WHITE
- STD18700P** PINK



SPECIAL EVENT CUPS
8" Plastic



- STD18775** WHITE

SPECIALTY CUP HOLE CUTTERS



- STD28775** STANDARD 6" HOLE CUTTER
- STD28785** STANDARD 8" HOLE CUTTER

STANDARD GOLF CUP CADDIE
Utility Cart Rack For Golf Cups



- STD18990**

Pricing is subject to change.

HIO XACT

HIO XACT HOLE CUTTER



- Advanced ratcheting system for easy plug removal
- Three linear guide rails ensure accurate, smooth, and consistent operation
- Revolutionary three-way locking system
- Built-in bubble level
- Molded on grips
- Enhanced blade technology
- Depth gauge allow for uniform cup depth every time



- PAR1006-1 INSIDE STRAIGHT
- PAR1006-2 OUTSIDE STRAIGHT
- PAR1010-01 INSIDE SHARPENED REPLACEMENT BLADE
- PAR1010-02 OUTSIDE SHARPENED REPLACEMENT BLADE
- PAR1033-1 DEPTH GAUGE
- PAR1033-2 DOCKING STATION

DEPTH GAUGE

DOCKING STATION



SG PRO HOLE CUTTER

Included Depth Gauge Allows For Uniform Cup Depth Every Time



- Cut perfectly circular, crisp holes every time
- Safe for your body - lift and throw the hammer mechanism - saving stress on your back
- Ratchet ejection allows you to easily remove and place plugs as needed, in full
- Will easily cut through the hardest "push up" greens and perform equally as well in USGA greens
- Easy for all crew members to operate
- Included depth gauge allows for uniform cup depth every time.
- Bubble level embedded in handle
- To lubricate moving parts, use a good quality white lithium grease available from auto parts or farm stores

- STD29000 INSIDE STRAIGHT
- STD29010 OUTSIDE STRAIGHT
- STD29001 INSIDE SHARPENED REPLACEMENT BLADE
- STD29002 OUTSIDE SHARPENED REPLACEMENT BLADE
- STD29003 SG DEPTH GAUGE
- STD29004 SG DOCKING STATION

DOCKING STATION



SHOLE HOLE CUTTER SYSTEM

Includes Shoe, Cutting Board, & Depth Rings



- GCA1013KIT-COM SHOLE HOLE CUTTER SYSTEM-COMPRESSION (SAND GREENS)
- GCA1013KIT-NON SHOLE HOLE CUTTER SYSTEM-NON COMPRESSION (NATIVE GREENS)
- GCA1013COM INSIDE SHARPENED REPLACEMENT BLADE
- GCA1013NON OUTSIDE SHARPENED REPLACEMENT BLADE
- GCA1013HG HOLE CUTTING GUIDE WITH DEPTH RINGS
- GCA1013-COM SHOLE HOLE CUTTER ONLY-COMPRESSION (SAND GREENS)
- GCA1013-NON SHOLE HOLE CUTTER ONLY-NON COMPRESSION (NATIVE GREENS)

PAR AIDE HOLE CUTTERS



1. LEVER ACTION HOLE CUTTER

- PAR1001-1 INSIDE SCALLOPED
- PAR1001-2 OUTSIDE SCALLOPED
- PAR1001-3 INSIDE STRAIGHT
- PAR1001-4 OUTSIDE STRAIGHT

LEVER ACTION WITH BUBBLE LEVEL

- PAR1001-19 INSIDE SCALLOPED
- PAR1001-29 OUTSIDE SCALLOPED
- PAR1001-39 INSIDE STRAIGHT
- PAR1001-49 OUTSIDE STRAIGHT

2. FOOT EXTRACTION HOLE CUTTER

- PAR1002-1 INSIDE SCALLOPED
- PAR1002-2 OUTSIDE SCALLOPED
- PAR1002-3 INSIDE STRAIGHT
- PAR1002-4 OUTSIDE STRAIGHT

FOOT EXTRACTION WITH BUBBLE LEVEL

- PAR1002-19 INSIDE SCALLOPED
- PAR1002-29 OUTSIDE SCALLOPED
- PAR1002-39 INSIDE STRAIGHT
- PAR1002-49 OUTSIDE STRAIGHT

HIO HOLE CUTTER

Par Aide



- Superintendents everywhere have been won over by it's precision, ease-of-use, time, and body-saving ability
- Simply pull out the pin, lift the handle, and the hammer action will pound the hole cutter into the ground



- PAR1003-1 INSIDE SHARPENED BLADE
- PAR1003-2 OUTSIDE SHARPENED BLADE
- PAR1009-01 REPLACEMENT INSIDE BLADE
- PAR1009-02 REPLACEMENT OUTSIDE BLADE



STANDARD GOLF HOLE CUTTERS



1. MAGNUM LEVER ACTION HOLE CUTTER

- STD28960 INSIDE STRAIGHT SHELL
- STD28970 INSIDE SCALLOPED SHELL
- STD28980 OUTSIDE SCALLOPED SHELL

2. MAGNUM PRO HOLE CUTTER

- STD28920 INSIDE STRAIGHT SHELL
- STD28930 INSIDE SCALLOPED SHELL
- STD28940 OUTSIDE SCALLOPED SHELL

3. PRO II REGULATION FOOT EXTRACTION HOLE CUTTER

- STD28700 INSIDE STRAIGHT- 4.25" SHELL DIA.
- STD28800 INSIDE SCALLOPED - 4.25" SHELL DIA.
- STD28801 OUTSIDE SCALLOPED- 4.25" SHELL DIA.

4. HAMMERSTRIKE HOLE CUTTER

- STD29060 OUTSIDE STRAIGHT SHELL

5. TURF MASTER HOLE CUTTER

- STD28000 4-1/4" (11 CM) DIAMETER



REPLACEMENT BLADES
Standard Golf



- STD28927 INSIDE STRAIGHT
- STD28952 INSIDE SCALLOPED
- STD28953 OUTSIDE SCALLOPED
- STD28777 6" PRO II SHELL
- STD28787 8" PRO II SHELL



REPLACEMENT BLADES
Par Aide



- PAR1007-01 INSIDE STRAIGHT
- PAR1007-02 OUTSIDE STRAIGHT
- PAR1008-01 INSIDE SCALLOPED
- PAR1008-02 OUTSIDE SCALLOPED

BLADE SHARPENER



STD28400



PINPOINT CUP CHANGER



- Increased leverage improves efficiency.
- Easily remove and place cups without bending over, saving your lower back
- Set cups without damaging cup edges or leaving indents on the turf
- Adjust ferrule height for perfect cup depth
- To lubricate moving parts, use a good quality white lithium grease available from auto parts or farm stores

STD33300



PAR AIDE CUP PULLER



- Features long rod and rubber handle for maximum leverage and comfort. Plated steel construction. Three-hook design pulls cup out of hole straight and with ease, with no damage to the turf.

PAR1032 INSIDE STRAIGHT

115 VOLT ELECTRIC CUP CUTTER SHARPENER



SHPECS3.5



TURNING BOARDS

- Made to prevent damage to collars or clean-up passes while turning walk mowers
- Made of lightweight HDPE material for easy transportation and long life span
- Comes in two size
24" x 48"
24" x 96"

GCATB24X48 24" X 48"

GCATB24X96 24" X 96"

GCATB48X96 48" X 96"



PW HOLE CUTTER GUIDE



PWPCHCG_-

Use Our Perma-Core Color Option Key To Choose Your Color!

HOLE CUTTER GUIDE



PAR1030

CUP SETTER



PAR1031 ALUMINUM
STD30100 PLASTIC

DEPTH GAUGE



PAR1034 PAR AIDE
STD28600 STANDARD GOLF

CUP HOLE TRIMMING SCISSORS



PAR1036

CUP HOOK

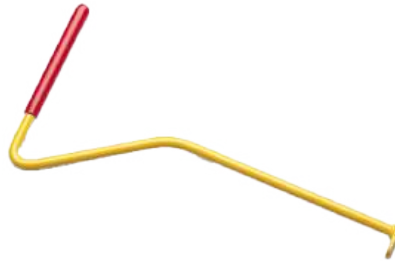

STD33200

GREEN KEEPERS BUCKET



GCA0937

CREW CADDY



PAR1038

HOLE CUTTER CARRIER



PAR1011

CLEAN CUT CUP AUGER



PAR655661

CUP HOLE CLEANER



PAR950

DELUXE METAL CUP SETTER



STD30200

HOLE GROOMER

- Refresh your practice green holes daily
- Quick and simply place into existing hole and pull the lever
- Hole is firmed and cleaned to exact proper size with crisp edges

GCA0922

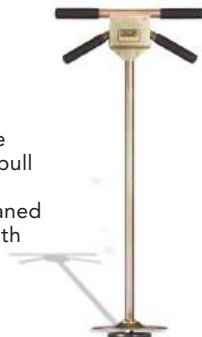

Pricing is subject to change.

HOLE IN WHITE PAINT



- Our best selling brand for years
- More visible target that can speed up play
- Improve/upgrade course standards to tournament levels
- Plastic shield used to protect cups from overspray
- Sold in cases of 12 cans
- Also available in pink for special tournaments. **Pink paint sold in cases of 6 only.**

- GCAHIWD** DEVICE
- GCAHIWP** CASE OF PAINT
- GCAHIWP-D** PLASTIC SHIELD
- GCAHIWPPK** PINK PAINT

360 HOLE PAINT



- Paints the top 1" above the cup white using a unique nozzle that sprays 360 degrees all at once.
- Simply push down on the paint can 2-4 times to whiten
- Cup shield rests on top of the cup to protect against over-spray and dripping.
- No rotating of the can is necessary
- Sold in case of 12 cans

- PAR911** DEVICE
- PAR910** CASE OF PAINT
- PAR911-2** PLASTIC SHIELD (10 PACK)

E-ZEE WHITE HOLE WHITENER



- Clean, crisp white holes made quick and easy.
- Simply insert paint can into tool and rotate.
- Specially formulated to maximize whiteness on dirt.
- Built-in shield protects cup and green from overspray
- One-piece patented design; no assembly required.

- STD55600** DEVICE
- STD55700** CASE OF PAINT

PAINT SOLD IN CASES OF 6 CANS

PAR AIDE CUP SAVER



- Protects cups while spraying Greens, topdressing, or painting edges
- Made of durable plastic
- Cone shaped with easy grab stem
- Set of 5 cup savers

PAR1073

TARGET RINGS



- Used in place of paint to whiten the top edge of the cup
- Plastic ring protects the edge of the cup
- Great for practice Greens where cups aren't changed daily
- Sold in case of 18 rings

GCAGHT WHITE RINGS

TARGET RING & CUP SETTER



- Made specifically for use with hole targets
- Use as cup setter as well
- Made of cast aluminum

PAR655626

PAR AIDE AERIFYING CUP PLUGS



SET OF 9

Made from durable, lightweight, weather-resistant foam material
Used when aerating greens to protect integrity of the hole
Used when topdressing greens to keep sand from filling up cup hole
Can be left in holes during winter months
Aeration tines able to penetrate plug without pulling it out of the hole

- PAR1070** REGULATION CUP SIZE
- PAR1071** PRACTICE CUP SIZE

PLASTIC CUP COVER



- 4 1/4" in diameter
- Economical cover "fills" top of the hole
- Sits on top of a recessed cup flush with the surface of the green
- Made from a synthetic polymer for a lighter and more durable construction
- Will not damage mower blades

STD18510

STEEL CUP COVER



- 4 1/4" in diameter
- Lid will sit flush to green when installed properly
- 4 1/4" (10.8 cm) cover is powder-coated steel.
- 6" (15.2 cm) and 8" (20.3 cm) covers are powdercoated aluminum.

- STD18500** 4 1/4" DIAMETER
- STD18650** 6" DIAMETER
- STD18750** 8" DIAMETER

REPLACEMENT PARTS

Par Aide Hio XACT Hole Cutter



HIO XACT



CAM PIN ASSEMBLY KIT
PAR1006-24 CALL FOR PRICING

HANDLE PIN ASSEMBLY KIT
PAR1006-26 CALL FOR PRICING

HANDLE PIVOT BUSHING KIT
PAR1006-32 CALL FOR PRICING

PROTECTIVE TUB KIT (Includes 3 red tubes)
PAR1006-21 CALL FOR PRICING

RATCHET RACK RAIL
PAR1006-27 CALL FOR PRICING

SLIDE BUSHING KIT (Includes 6 each bushings)
PAR1006-31 CALL FOR PRICING



REPLACEMENT PARTS
Par Aide Hio Hole Cutter

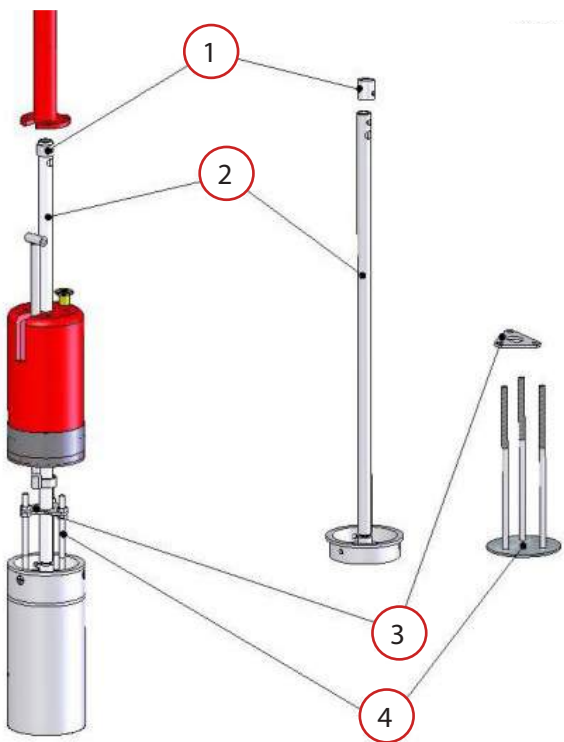

INTERNAL PARTS DIAGRAM

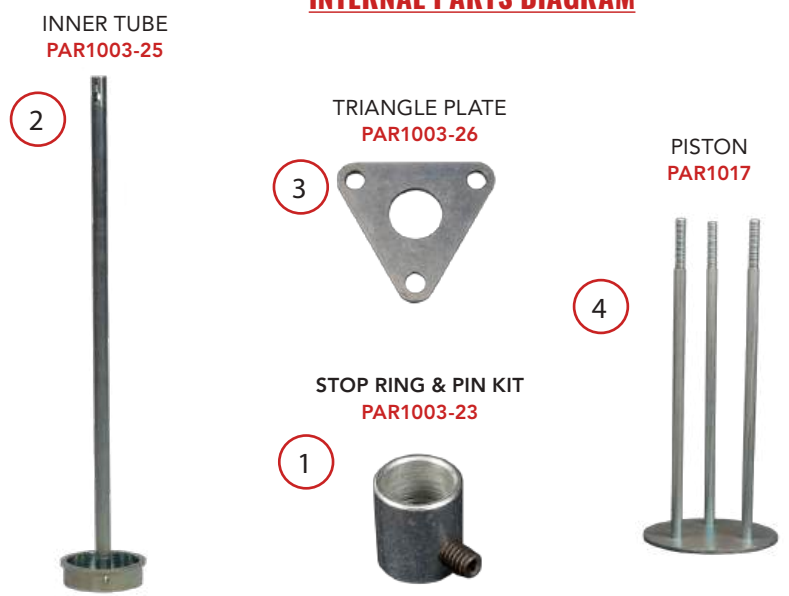

REPLACEMENT PARTS

Par Aide Lever Action Hole Cutter

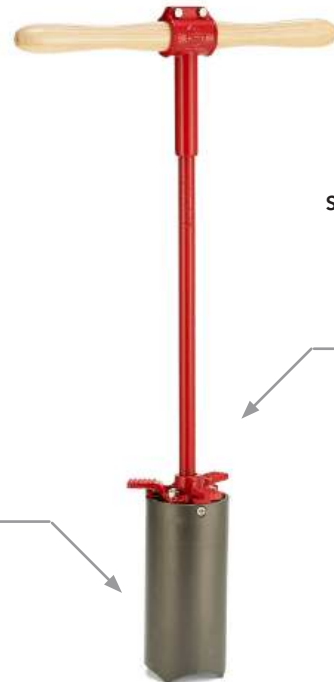
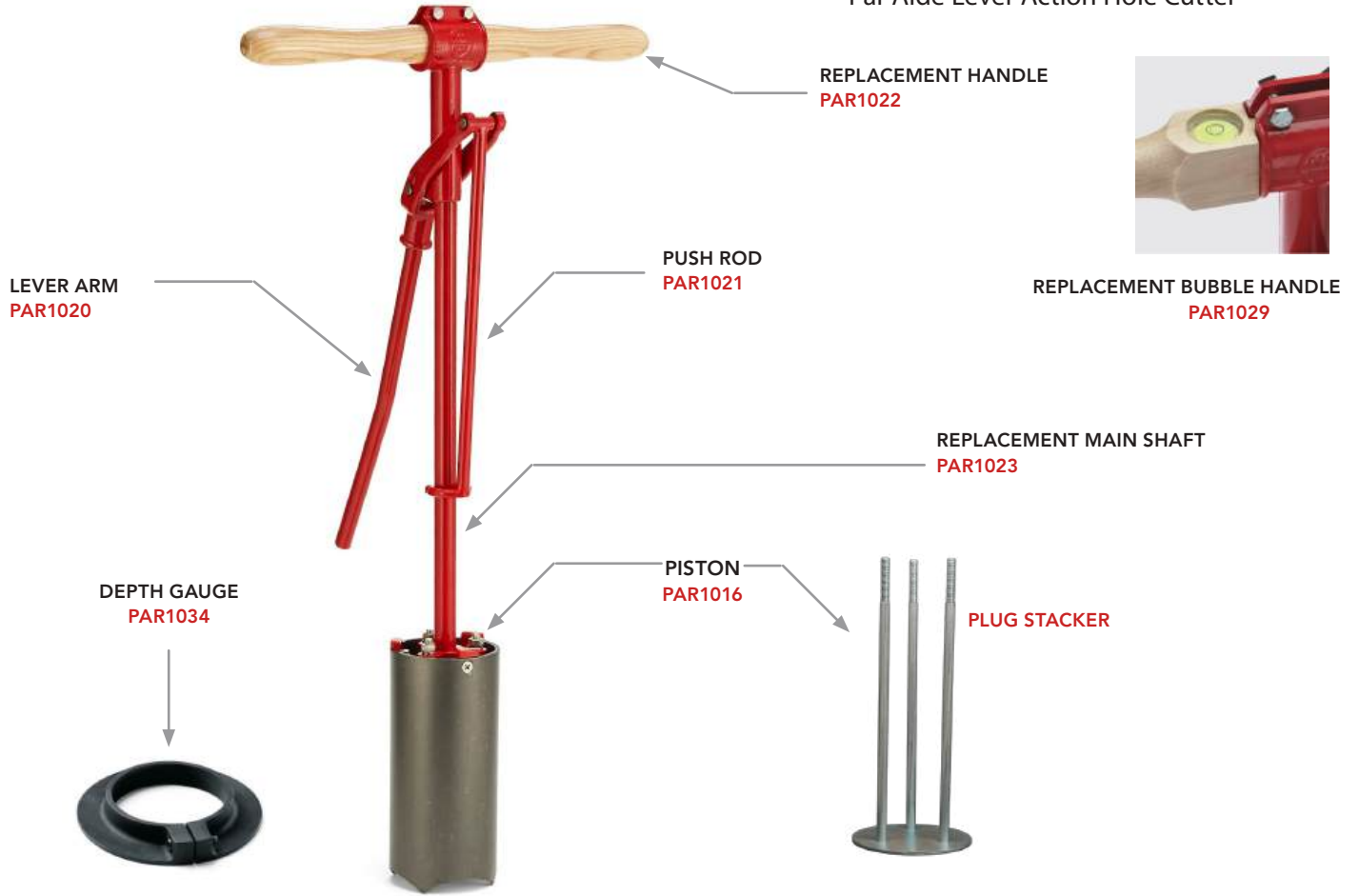

Foot Extraction Hole Cutter

Same parts as lever action above except for main shaft assembly



- REPLACEMENT BLADE, INSIDE SCALLOPED PAR1008-01
- REPLACEMENT BLADE, OUTSIDE SCALLOPED PAR1008-02
- REPLACEMENT BLADE, INSIDE STRAIGHT PAR1007-01
- REPLACEMENT BLADE, OUTSIDE STRAIGHT PAR1007-02

MAIN SHAFT ASSEMBLY PAR1024



GREENS BULLET



- Use in conjunction with quick-fill for amazing results
- See our video online
- Lightweight and durable stainless steel
- Adjustable depth collar

PAR550655

STEP 1



STEP 2



STEP 3



QUICK-FILL BALL MARK ERASER

- Improves the appearance of Greens damaged from ball marks
- Tube drops the perfect amount of sand into the ball mark every time
- No bending over or getting on your knees with a "ketchup" bottle

PAR550650



ACCUFIX
Ball Mark Repair Tool



PAR1092 BALLMARK TOOL
PAR1092-99 REPAIR KIT



ACCUFORM SLOT SEEDER



- Useful tool for any golf course
- Optimized for seed germination
- Flat bottom slot reaches the ideal depth of 1/2 in. for seed germination
- Great for worn areas

PAR543610



ACCUFORM ACCUSEED



PAR13270 ACCUSEED TOOL
PAR13270-9 ACCUSEED PLUG
PAR13270-20 REPLACEMENT BOTTOM PLATE
PAR13270-21 REPAIR KIT



PLUG STACKER
2 dia. and 3 dia.



2" INCH

PAR500102 2"



3" INCH

PAR500103 3"



GREENSKEEPER
Ball Mark Repair Tool

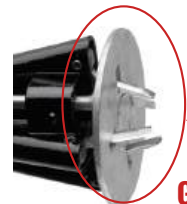

STD27200

GREENSKEEPER REPAIR KIT

All of the parts you need to repair your Greenskeeper

- 1-STD27202- Floor Plate
- 1-STD27203- Spring
- 1-STD27204- Spring Seat
- 4-STD27205- Fingers
- 4-STD27206- Roll Pin
- 2-STD27207- Snap Ring

STD27200R- COMPLETE KIT



THE FAIRWAY SNAKE

The Fairway Snake is a tool engineered specifically for the quick and easy removal of dew from fairways. The result is a patent-protected fairway dragging tool that cleans an entire fairway in a single pass. The Fairway Snake was developed to be gentle on turf as it rolls across the fairway, but also to be durable to withstand routine trips around the golf course. The Fairway Snake is the ideal tool for removing dew, grass clippings and earthworm castings from your fairways.

- Hugs the Fairway
- Weighted Core
- Extremely Flexible
- Strong, Durable and Reliable
- UV and Water Resistant
- Rolls or Spins Over the Turf

- TLTFS100** 100' ROPE
- TLTFS150** 150' ROPE
- TLTFS200** 200' ROPE



- Sweep away morning dew or worm castings
- Telescoping pole stretches from 6' to 16'
- Easy to handle



DU-WHIPPER

- STD34300** WHIPPING POLE
- STD34301** HANDLE SECTION W/ END CAP
- STD34302** MIDDLE SECTION W/ GRIP
- STD34303** TIP SECTION
- STD34304** ALUM. CAP FOR HANDLE
- STD34305** RUBBER CAP FOR GRIP



E-Z WHIP WHIPPING POLE

Slides In and Out of Handle

- PAR1060** WHIPPING POLE
- PAR1061** REPLACEMENT COUPLER
- PAR1065** REPLACEMENT TIP
- PAR1066** REPLACEMENT HANDLE
- PAR1067** REPLACEMENT GRIP
- PAR1068** BOTTOM PLUG FOR HANDLE
- PAR1069** COUPLER FOR FIBERGLASS TIP



GREENS SPEED METER

BREAKMASTER GREEN SLOPE METER



- Check slope of green before setting the cup
- Used by PGA, LPGA and Champions Tour Pros to read greens before Tournaments

LASER HEIGHT OF CUT PRISM GAUGE WITH CASE



PRISM GAUGE



ACUGS101

- TLTBM** BREAKMASTER
- TLTBMP** BREAKMASTER PLUS

- TLTHGRISM-LASER-INCH-G** INCHES MODEL
- TLTHGRISM-LASER-FIFA-G** FIFA METRICS MODEL

ACUPG01



ACCUFORM FOLDING DEW BRUSH

Par Aide Products

- This easy to open and close dew brush makes clearing dew off the turf simple.
- Easy to transport around the course and store in the maintenance facility
- Overlapping brush ensures that you are getting complete coverage
- 10 ft. (3 m) wide and lightweight

PAR555670



S550 PROFESSIONAL ROLLER SQUEEGEE

Professional Grade



- Removes water from greens and turf
- Non-absorbant roller
- 60" Ergonomic powder-coated aluminum

STD71324 24 INCH ROLLER SQUEEGEE

STD71336 36 INCH ROLLER SQUEEGEE

STD71348 48 INCH ROLLER SQUEEGEE

ACCUFORM ROLLER SQUEEGEE

Par Aide Products



- Removes water from greens and turf
- Non-absorbant roller features a heavy duty ribbed frame
- 60" bent, aluminum handle

PAR13220 24 IN. ROLLER & HANDLE

PAR13220-4 24 IN. ROLLER HEAD ONLY

PAR13224 36 IN. ROLLER & HANDLE

PAR13224-4 36 IN. ROLLER HEAD ONLY



TACIT DEW BRUSH

With Dew Whip



- Comes with an 8 foot wide brush head and 72 inch handle with internal dew whip
- Tacit produces two Dew Brushes for the discerning greenkeeper.
- Made with soft bristles that glides easily over the green clearing dew with a squeegee action
- Stiff bristles flicks the dew into larger droplets forcing them to be absorbed by the soil
- Both are light and easy to carry and both use Tacit's Switch as their handle

GCA1035 GREEN

SOD KNIFE

TLTSK3
HEAVY DUTY STAINLESS
STEEL

TLTSKB2
BLUE HANDLE, SERRATED
BLADE

TLTCK
COTTON KNIFE

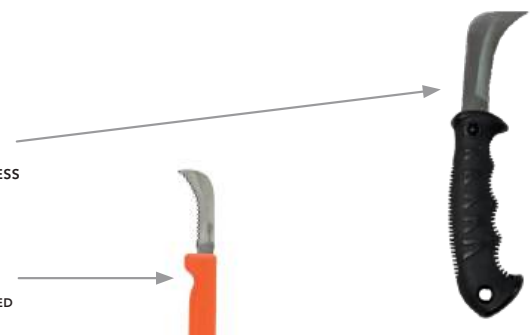

COTTON

ICE PICK



TLTIP

110 BUNKER MAINTENANCE

Accuform Ace II



PAR AIDE BUNKER RAKE HEADS

| PART # | WIDTH | TYPE |
|-----------|-------|-----------------|
| PAR990-01 | 17" | ACCUFORM ACE II |
| PAR995-01 | 25" | ACCUFORM ACE II |
| PAR997-01 | 15" | ACCUCURVE |



Accucurve

ALL HEADS LISTED ARE COMPATIBLE WITH ALL HANDLES BELOW

BUNKER RAKE HANDLES

All handles here are compatible with the heads above. Don't be fooled into the the knock-off handles out there that don't have the quality and dependability you get from these.

| PART # | LENGTH | DESCRIPTION |
|-----------|--------|------------------|
| PAR972-8 | 54" | PROTECT- GREEN |
| PAR972-9 | 72" | PROTECT- GREEN |
| PAR972-1 | 54" | HONEYCOMB- GREEN |
| PAR972 | 54" | GREEN ALUMINUM |
| PAR972-10 | 54" | BROWN ALUMINUM |
| PAR972-7 | 96" | GREY ALUMINUM |

Fiberglass Protect Handle



Fiberglass Honeycomb Handle



Aluminum Green Handle



Aluminum Brown Handle



RAKE HANDLE GRIPS

Pack Of 10

PAR974-10



RAKE HANDLE DECALS

Set Of 13

- PAR965-1 LEAVE RAKES IN BUNKERS DECAL
- PAR965-2 LEAVE RAKES OUT BUNKERS DECAL



ACCUFORM ACE II RAKES KITS

Our Best Selling Rakes

17" HEADS - BOXES OF 25 - BEST VALUE

- PAR990-125 17 IN. ACE II 54 IN. HUNTER GREEN HONEYCOMB HANDLE
- PAR990-525 17 IN. ACE II 54 IN. HUNTER GREEN ALUMINUM HANDLE
- PAR990-825 17 IN. ACE II 54 IN. HUNTER GREEN PROTECT HANDLE
- PAR990-1025 17 IN. ACE II 54 IN. SIENNA BROWN ALUMINUM HANDLE
- PAR990-925 17 IN. ACE II 72 IN. HUNTER GREEN PROTECT HANDLE

25" HEADS - BOXES OF 25 - BEST VALUE

- PAR995-125 25 IN. ACE II 54 IN. HUNTER GREEN HONEYCOMB HANDLE
- PAR995-525 25 IN. ACE II 54 IN. HUNTER GREEN ALUMINUM HANDLE
- PAR995-825 25 IN. ACE II 54 IN. HUNTER GREEN PROTECT HANDLE
- PAR995-1025 25 IN. ACE II 54 IN. SIENNA BROWN ALUMINUM HANDLE
- PAR995-925 25 IN. ACE II 72 IN. HUNTER GREEN PROTECT HANDLE



ACCUCURVE RAKE KITS

15" Head - Box of 25

Its design combines the profile of our Bunker Pro rake with the lightweight feel of the Accuform Ace II.

- PAR997-125 54 IN. HUNTER GREEN HONEYCOMB HANDLE
- PAR997-525 54 IN. HUNTER GREEN ALUMINUM HANDLE
- PAR997-825 54 IN. HUNTER GREEN PROTECT HANDLE
- PAR997-1025 54 IN. SIENNA BROWN ALUMINUM HANDLE
- PAR997-925 72 IN. HUNTER GREEN PROTECT HANDLE

Pricing is subject to change.

STANDARD GOLF BUNKER RAKE HEADS



| PART # | WIDTH | TYPE |
|----------|-------|----------------|
| STD11901 | 20" | THE CHIEF |
| STD11701 | 20" | TOUR PRO |
| STD11771 | 25" | TOUR PRO |
| STD11801 | 15" | TOUR SMOOTH II |
| STD12202 | 22" | TOUR SMOOTH II |
| STD12301 | 15" | TOUR-LITE |
| STD11601 | 15" | ECONOMY |
| STD11501 | 15" | DUO-RAKE |



"THE CHIEF" RAKE KITS

20" Head for Aussie Style Raking



- STD11900 54 IN. GREEN ALUMINUM HANDLE - CASE OF 12
- STD11910 60 IN. GREEN GATOR GRIP HANDLE - CASE OF 12
- STD11920 72 IN. GREEN GATOR GRIP HANDLE - CASE OF 6

TOUR PRO RAKE KITS

20" Or 25" Head



20" HEADS

- STD11760 54 IN. GREEN ALUMINUM HANDLE (CASE OF 12)
- STD11700 54 IN. GREEN COMPOSITE HANDLE (CASE OF 12)
- STD11720 60 IN. GREEN GATOR GRIP HANDLE (CASE OF 12)
- STD11730 60 IN. BROWN GATOR GRIP HANDLE (CASE OF 12)
- 25" HEAD
- STD11790 60 IN. GREEN GATOR GRIP HANDLE (CASE OF 6)
- STD11770 72 IN. GREEN GATOR GRIP HANDLE (CASE OF 6)
- STD11780 72 IN. BROWN GATOR GRIP HANDLE (CASE OF 6)

TOUR-LITE RAKE KIT

15" Head Option



- STD12375 54 IN. GREEN ULTRA LIGHT STEEL - CASE OF 12
- STD12350 54 IN. YELLOW ULTRA LIGHT STEEL - CASE OF 12

TOUR SMOOTH II RAKE KITS

15" & 22" Head Options



- STD11800 54 IN. GREEN COMPOSITE HANDLE - CASE OF 12
- STD11820 60 IN. GREEN GATOR GRIP HANDLE - CASE OF 12
- STD11830 60 IN. BROWN GATOR GRIP HANDLE - CASE OF 12
- STD11860 54 IN. GREEN ALUMINUM HANDLE - CASE OF 12
- STD12210 60 IN. GREEN GATOR GRIP HANDLE - CASE OF 6

CART RAKE KIT

15" Head Option



- STD11400 48 IN YELLOW WOOD HANDLE, CASE OF 12
- STD11425 48 IN GREEN WOOD HANDLE, CASE OF 12

112 BUNKER MAINTENANCE



DUO-RAKE KIT 15" Head Option



- STD11575 54 IN. GREEN ALUMINUM - CASE OF 12
- STD11525 54 IN. YELLOW ALUMINUM - CASE OF 12
- STD11500 54 IN. NATURAL ALUMINUM - CASE OF 12
- STD11540 64 IN GREEN CURVED HANDLE, CASE OF 6
- STD11530 64 IN GOLD CURVED HANDLE, CASE OF 6
- STD11545 72 IN GREEN COMPOSITE HANDLE, CASE OF 12



ECONOMY RAKE KIT 15" Head Option



- STD11665 54 IN. GREEN ULTRA LIGHT STEEL - CASE OF 12
- STD12350 54 IN. YELLOW ULTRA LIGHT STEEL - CASE OF 12
- STD11625 48 IN GREEN WOOD HANDLE

BUNKER RAKE HANDLES

| PART # | LENGTH | DESCRIPTION |
|---------------|--------|-----------------------|
| STD11200 | 60" | GREEN GATORGRIP |
| STD11210 | 72" | GREEN GATORGRIP |
| STD11201 | 60" | BROWN GATORGRIP |
| STD11211 | 72" | BROWN GATORGRIP |
| STD11710 | 54' | GREEN COMPOSITE |
| STD11516 | 54' | GREEN ALUMINUM |
| STD11205 | 54' | NATURAL ALUMINUM |
| STD11515 | 54' | YELLOW ALUMINUM |
| STD11532 | 64' | GOLD ALUMINUM |
| NEW! STD11220 | 60" | WOOD- GRAIN COMPOSITE |
| NEW! STD11221 | 72" | WOOD- GRAIN COMPOSITE |



GATOR GRIP HANDLES

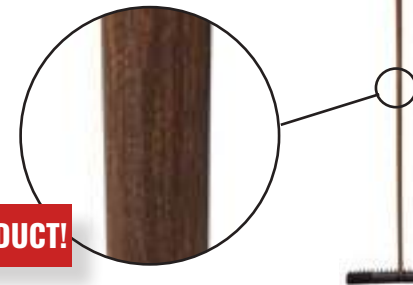

NEW PRODUCT!

WOOD-GRAIN COMPOSITE HANDLE

RAKE HANDLE CAPS

- STD11206 7/8" RAKE HANDLE CAP
- STD11207 15/16" RAKE HANDLE CAP



RAKE HANDLE DECALS

Set Of 13

- PAR965-1 LEAVE RAKES IN BUNKERS DECAL
- PAR965-2 LEAVE RAKES OUT BUNKERS DECAL



VINYLSHIELD FOR RAKE HANDLES

Easiest Way to Re-new Your Rakes



BEFORE

AFTER

No more fiberglass splinters from your rake handles. An economical and easy way to re-new your rakes and protect splintered, cracked, faded, scratched, dirty fiberglass handles. Quickly applies with heat gun and will last for years. *Heat sensitive material, exposure to temperatures over 90F (32C) may cause premature shrinkage.*

- VSRH-125-BK BLACK 125' ROLL
- VSRH-250-BK BLACK 250' ROLL
- VSRH-125-GN GREEN 125' ROLL
- VSRH-250-GN GREEN 250' ROLL
- VSRH-125-YW YELLOW 125' ROLL
- VSRH-250-YW YELLOW 250' ROLL

125' feet does about 25 handles. 250 does about 50 handles

HIGH TEMPERATURE HEAT GUN Use To Shrink VinylShield Tubing



- Economical, multi-purpose heat gun
- Heavy duty air blower provides rapid shrinking

VSVT-HG

Pricing is subject to change.

NEW PRODUCT!

TRI-HEAD RAKE

Ideal For Large Bunkers And High-Traffic Areas



- Versatile Use – Effective on sand, pine straw, leaves, and debris
- 72" wide head features 3 spring tine rake heads at exactly the right angle and provides extended reach to improve ergonomics and control
- Time-Efficient – Covers more ground in less time
- Fast, Consistent Results – Delivers a smooth, even finish
- Weighs 9 lbs.

TLTTHR72 78" TRI-HEAD RAKE

TLTRHR-24 SPRING BACK RAKE HEAD ONLY

NEW DESIGN!

DUAL HEAD RAKE

Cover More Ground In Fewer Passes

- Makes raking bunkers, pine straw or debris go much faster
- 48" wide head features 2 spring tine rake heads at exactly the right angle
- Versatile Use – Perfect for golf courses, parks, and grounds maintenance
- Weighs 6 lbs.



TLTDHR48

78" DUAL HEAD RAKE

TLTRHR-24

SPRING BACK RAKE HEAD ONLY

BUNKER DEBRIS SIEVE



- The easy way to sift sand and to remove bunker debris and stones.
- 19" (48 cm) head
- 72" (183 cm) - 2 piece wood handle
- Available with 1/2" (1.3 cm) openings or 1/4" (.64 cm) openings

STD29335 19" HEAD W/ 72" WOOD HANDLE (1/2" OPENINGS)

STD29330 19" HEAD W/ 72" WOOD HANDLE (1/4" OPENINGS)

MECHANICAL RAKE ATTACHMENTS

SPRING TINE RAKE HEADS

Replacement Rake Head Only - No Frame



Replacement spring back rake heads are 24" wide each. The bolt through head mounts easily onto your existing set-up.

FRAME NOT INCLUDED

CORRK24003-8 - RAKE HEAD ONLY

CULTI-TINES

For Loosening Sand



The culti-tine helps loosen compact bunker sand while avoiding pulling up barrier fabrics, stones and any subsurface materials.

ACUSLT-20 BAG OF 20

NO SNAG RAKE PRONG



The no snag rake prong digs into the sand to loosen it without catching liners or rocks.

CTI4-175A

114 BUNKER MAINTENANCE

SEYMOUR SPADE SHOVEL

Made to Edge Bunkers



We searched all over for the perfect shovel to edge bunkers and we found the Seymour Spade Shovel with a straight blade to cut the perfect edge.

- 14 Gauge
- 7 Inch x 12 inch straight blade
- Rear rolled step
- Fiberglass insert & permagrip™
- Industrial grade fiberglass handle comes in two sizes

SEY49454 30" D GRIP HANDLE

SEY49453 48" STRAIGHT HANDLE

ACCUFORM DEEP FACE RAKE



PAR995-7

8' ALUMINUM HANDLE W/ 25" ACCUFORM HEAD

MAINTENANCE RAKE



- Comes with a 60" padded fiberglass handle
- Great for removing debris without bringing sand out at the same time
- Fluffs bunker sand without moving it

STD11300 21" WIDE HEAD

ACCUSMOOVE MAINTENANCE BUNKER RAKE



- 22" wide maintenance bunker rake head
- Comes in 66" or 82" in orange powder coated aluminum handles

PAR13130 22" WIDE HEAD W/ 66" ORANGE POWDER COATED ALUMINUM HANDLE

PAR13134 22" WIDE HEAD W/ 82" ORANGE POWDER COATED ALUMINUM HANDLE

PAR13130-1 22" WIDE RAKE HEAD ONLY

PAR13120-2 66" ORANGE POWDER COATED ALUMINUM HANDLE ONLY

ACCUFORM LANDSCAPE RAKE



- Long rounded teeth for smooth, non-gouging raking action and a large striking edge excellent for grading.
- Comes in 24", 36" or 48" rake head widths.
- Comes in 66" orange powder coated aluminum handle

PAR13110 24" WIDE HEAD W/ 66" ORANGE POWDER COATED ALUMINUM HANDLE

PAR13114 36" WIDE HEAD W/ 66" ORANGE POWDER COATED ALUMINUM HANDLE

PAR13118 48" WIDE HEAD W/ 66" ORANGE POWDER COATED ALUMINUM HANDLE

PAR13120-2 66" ORANGE POWDER COATED ALUMINUM HANDLE ONLY

ACCUFORM SCREENING RAKE



- Designed for sifting, grading and screening stones and debris from sand or fine soil.
- Comes in 24" or 36" rake head widths.
- Comes in 66" orange powder coated aluminum handle

PAR13120 24" WIDE HEAD W/ 66" ORANGE POWDER COATED ALUMINUM HANDLE

PAR13124 36" WIDE HEAD W/ 66" ORANGE POWDER COATED ALUMINUM HANDLE

PAR13120-2 66" ORANGE POWDER COATED ALUMINUM HANDLE ONLY

Pricing is subject to change.

900 FEET
600 FEET
300 FEET



Rust-oleum

Seymour

RUST-OLEUM PRECISION TURF MARKING PAINT

The Best Quality Marking Paint for Golf

- STD55001 WHITE
- STD55002 YELLOW
- STD55003 RED
- STD55004 ORANGE
- STD55005 GREEN
- STD55006 BLUE
- STD55007 FLORESCENT PINK
- STD55008 FLORESCENT ORANGE
- STD55009 FLORESCENT GREEN

FREE FREIGHT ON 31 OR MORE CASES

- All paint sold in cases of 12 cans
- other colors available
- Marks up to 250% more linear feet than other brands; precision tip with virtually no overspray
- Resists early fading and chalking
- Dries in under 5 minutes



- Bright, durable, and will not hurt and will not kill the grass.
- We offer all the colors needed to paint golf course marking including lateral and water hazards.
- Easy to use and easy to dispose of.
- Bright colors for high visibility.
- Durable so the course marking can be done less frequently.
- Golf course marking paints are formulated to be environmentally friendly, high in solids, low odor, durable, and with superior coverage.



DURA-STRIPE MARKING PAINT

- DSWH WHITE
- DSYW HIGH VISIBILITY YELLOW
- DSRB CAUTION BLUE
- DSGR SAFETY GREEN
- DSRED SAFETY RED

RUST-OLEUM PRECISION LINE INVERTED MARKING CHALK

Sold In Cases Of 12



STD55301 WHITE

ATHLETIC TURF STRIPING PAINT

Case Of 12 Cans



- RUS206043 WHITE
- RUS206045 YELLOW
- RUS206044 ORANGE

FREE FREIGHT ON 31 OR MORE CASES

DOUBLE BARREL PAINT GUN



PAR12403

HARD SURFACE STRIPING PAINT

For Concrete Or Asphalt



- STD55204 WHITE
- STD55205 YELLOW
- STD55202 LIGHT BLUE
- STD55203 RED
- STD55201 BLACK

FREE FREIGHT ON 24 OR MORE CASES

PAINT MARKING GUN



STD55000

STRIPING MACHINE



- STD55100 ATHLETIC FIELD
- STD55200 HARD SURFACE

- Creates bright, sharp, well-defined lines; resists smudging
- For indoor/outdoor use on concrete, gravel or other types of pavement
- Dries in less than 10 minutes
- Sold in cases of 6 cans

HAZARD MARKER TOPS

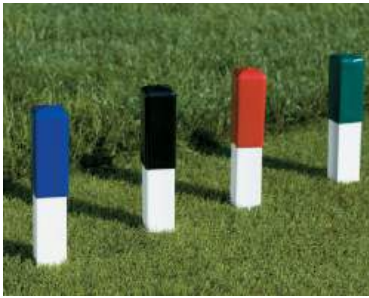

- Molded plastic caps fit on top of any of our recycled lumber stakes
- Use to mark special areas like environmentally sensitive areas or cart entrance / exits
- 1.5" x 1.5" x 4" long
- Sold in packs of 25

| | |
|----------------|--------|
| PWVC-WH | WHITE |
| PWVC-RD | RED |
| PWVC-GN | GREEN |
| PWVC-BK | BLACK |
| PWVC-RB | BLUE |
| PWVC-YW | YELLOW |

RECYCLED HAZARD STAKES

With Spike & Beveled Top

- Recycled lumber plastic stake with traditional top
- 6" stainless spike
- UV resistant colors won't fade
- 1 1/2" square lumber



12" HAZARD STAKES

| | |
|---------------------|--------|
| PWRPS-200-12 | WHITE |
| PWRPS-300-12 | YELLOW |
| PWRPS-100-12 | RED |
| PWRPS-500-12 | BLUE |

18" HAZARD STAKES

| | |
|---------------------|--------|
| PWRPS-200-18 | WHITE |
| PWRPS-300-18 | YELLOW |
| PWRPS-100-18 | RED |
| PWRPS-500-18 | BLUE |

24" HAZARD STAKES

| | |
|---------------------|--------|
| PWRPS-200-24 | WHITE |
| PWRPS-300-24 | YELLOW |
| PWRPS-100-24 | RED |
| PWRPS-500-24 | BLUE |

36" HAZARD STAKES

| | |
|---------------------|--------|
| PWRPS-200-36 | WHITE |
| PWRPS-300-36 | YELLOW |
| PWRPS-100-36 | RED |
| PWRPS-500-36 | BLUE |

Custom sizes available up to 48"
All stakes made in-house.

FORCE FLEX MARKERS

Mow Over in Any Direction



- 19" Tall
- One piece, no sleeve or cap to replace.
- Drive over with cart and mowers in any direction and the force flex will bounce back up every time.
- Uv-resistant rod will not fade in the sun.
- Ground anchor sold separately
- Sold in sets of 12

| | |
|-----------------|--------|
| STD15601 | WHITE |
| STD15701 | YELLOW |
| STD15801 | RED |
| STD15901 | BLUE |
| STD15500 | ANCHOR |

SOLD IN CASES OF 12



FLEXSTAKE HAZARD MARKERS

Mow Over in 2 Directions

| | |
|--------------------|---------------|
| FLXFG401-BU | BLUE 17.5" |
| FLXFG401-WH | WHITE 17.5" |
| FLXFG401-RD | RED 17.5" |
| FLXFG401-YW | YELLOW 17.5" |
| FLXFG402-BU | BLUE 24" |
| FLXFG402-WH | WHITE 24" |
| FLXFG402-YW | YELLOW 24" |
| FLXFG402-RD | RED 24" |
| FLXAN500 | GROUND ANCHOR |

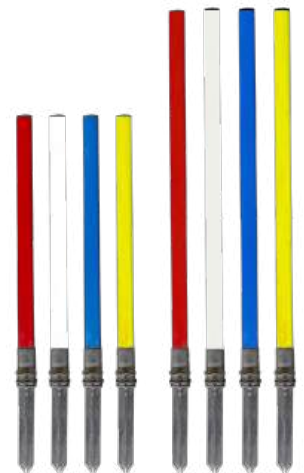

KIRBY FAIRWAY MARKERS



UV COATING

RAISED SURFACE



- KBY-CO-___-__ MARKER COMPLETE WITH NUMBERS
- KBY-CO-___-B MARKER COMPLETE - NO NUMBERS
- KBY-TP-___-__ TOP ONLY WITH NUMBERS
- KBY-TP-___-B TOP ONLY - NO NUMBERS
- KBY-CL-___ COLLAR ONLY
- KBYNL REPLACEMENT LEAF W/ #
- KBYPL REPLACEMENT LEAF NO #
- KBYAP-1 ANCHOR MOUNT PIPE
- KBYAT-1 ANCHOR MOUNT TABS
- KBYSC-C MOUNTING SCREW FOR ANCHOR
- KBYSC-T MOUNTING SCREW FOR TOP CAP
- KBYTC-1 TURF CUTTER FOR INSTALL
- KBYPP-1 POUNDING PLATE FOR INSTALL

- Kirby Markers speeds up play by up to 36 minutes per foursome.
- Collapse under mowers, saving your crew from having to pull out fairway markers
- Mower-friendly, resulting in much less mower blade wear and tear
- Ability to withstand snow, rain, extreme heat, ice and mud.
- Kirby Markers require less maintenance than traditional markers, saving the course on daily maintenance.
- There are advertising possibilities created by Kirby Markers.

We can create any color/number combination as well as customization on collars like club logos, advertisers, sponsors, and more. Call us for a quote!

FAIRWAY YARDAGE POLES

2" Diameter x 60" Tall

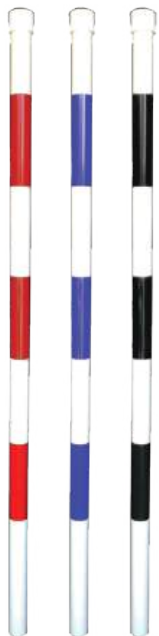

- Heavy duty PVC pole 1 1/2 in. diameter, 60 in. tall
- Includes PVC ground anchor for mounting.

- PWFPST-BW BLACK & WHITE
- PWFPST-WB BLUE & WHITE
- PWFPST-RW RED & WHITE



FAIRWAY MARKING POLES

4" Diameter x 48" Tall

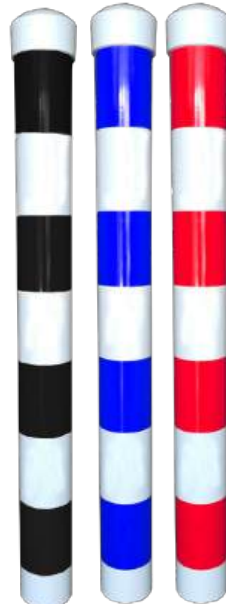

- Heavy duty PVC pole 4 in. diameter, 48 in. tall - not the thin, brittle pipe used by our competitors.
- Includes PVC ground anchor for mounting.
- Added due to popular demand from our customers!

- PWFPST4-BW BLACK & WHITE
- PWFPST4-WB BLUE & WHITE
- PWFPST4-RW RED & WHITE

118 COURSE & YARDAGE MARKINGS

CUSTOM COURSE YARDAGE MARKERS



- 36" recycled lumber stake with 6" x 8" flag mounted inside the stake
- These are great yardage marker because they are tall and highly visible
- Comes with a sleeve for a permanent but can still easily be removed for mowing
- Flags can be custom logo if you buy 18 or more

| | |
|-----------------|-----------------------------|
| PWYPF-RD | YARDAGE POST - RED |
| PWYPF-WH | YARDAGE POST - WHITE |
| PWYPF-RB | YARDAGE POST - BLUE |
| PWYPF-C | YARDAGE POST W/ CUSTOM FLAG |

SOFT TOP MUSHROOM MARKERS



- 14" diameter
- Sits slightly above turf for greater visibility while depressing during mowing

| | |
|--------------------|-------------------------|
| GCASTM01-RD | COMPLETE MARKER - RED |
| GCASTM01-WH | COMPLETE MARKER - WHITE |
| GCASTM01-RB | COMPLETE MARKER - BLUE |
| GCASTM01T | REPLACEMENT TOP |
| GCASTM01B | REPLACEMENT BOTTOM |

PERMA CORE IN GROUND ROUND YARDAGE MONUMENTS

Comes With Two Stainless Steel Spikes
6", 8", 11" & 15" Options

6" 8" 11" 15"

| | |
|-----------------------------------|-------------------|
| PWPCRN-YARDAGE- SIZE-COLOR | NUMBERED MONUMENT |
| PWPCRN-C- SIZE-COLOR | CUSTOM MONUMENT |
| PWPCRN-P- SIZE-COLOR | PLAIN MONUMENT |

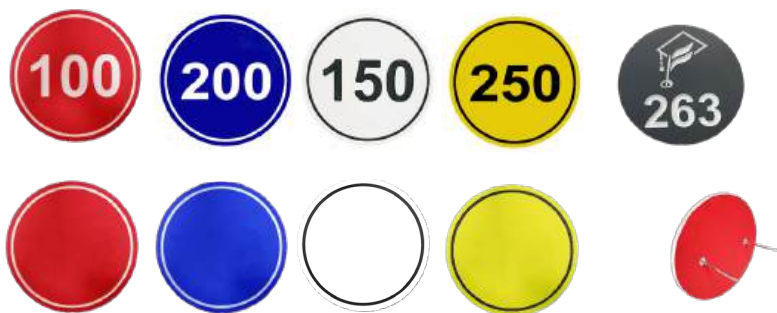

PERMA-CORE COLOR OPTION KEY



Call us for a quote for additional color options. Add logo to any marker above at additional cost.

PERMA CORE IN GROUND RECTANGLE YARDAGE MONUMENTS

Comes With Two Stainless Steel Spikes
8" X 12"

| | |
|-----------------------------|-------------------|
| PWPCRC-YARDAGE-COLOR | NUMBERED MONUMENT |
| PWPCRC-C-COLOR | CUSTOM MONUMENT |
| PWPCRC-P-COLOR | PLAIN MONUMENT |

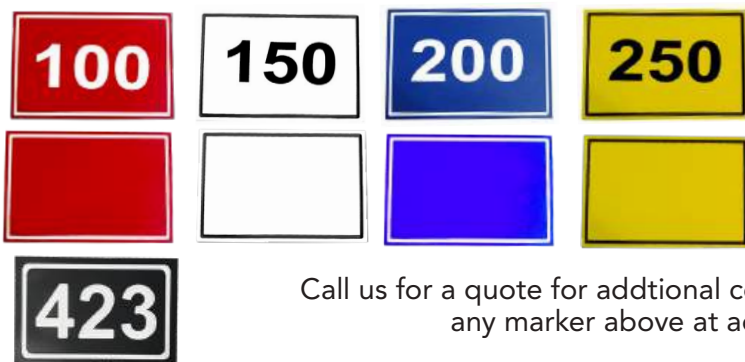

PERMA-CORE COLOR OPTION KEY



Call us for a quote for additional color options. Add logo to any marker above at additional cost.

Pricing is subject to change.

BRONZE & ALUMINUM COLOR OPTION KEY

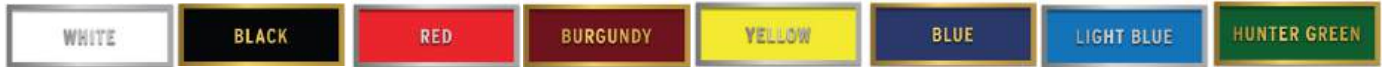

CART PATH YARDAGE MARKERS



BRONZE ALUMINUM ALUMINUM W/
COLOR

- Available in standard or custom yardages
- Includes two 2 1/2" (6 cm) zinc-plated, threaded studs
- Available in cast aluminum or cast bronze
- 9 inches long x 5.25 inches wide x 1.25 inches tall
- Cast Bronze - available with black or natural bronze background
- Cast Aluminum - available colors in color key above

| PART NUMBER | MATERIAL | BACKGROUND | YARDAGE |
|-----------------|----------|-------------|---------|
| PWPYZ-100-CL-RD | ALUMINUM | RED | 100 |
| PWPYZ-150-CL-WH | ALUMINUM | WHITE | 150 |
| PWPYZ-200-CL-BU | ALUMINUM | BLUE | 200 |
| PWPYZ-100-AL | ALUMINUM | BLACK | 100 |
| PWPYZ-150-AL | ALUMINUM | BLACK | 150 |
| PWPYZ-200-AL | ALUMINUM | BLACK | 200 |
| PWPYZ-250-AL | ALUMINUM | BLACK | 250 |
| PWPYZ-100-BZ-BK | BRONZE | BLACK | 100 |
| PWPYZ-150-BZ-BK | BRONZE | BLACK | 150 |
| PWPYZ-200-BZ-BK | BRONZE | BLACK | 200 |
| PWPYZ-250-BZ-BK | BRONZE | BLACK | 250 |
| PWPYZ-100-BZ | BRONZE | DARK BRONZE | 100 |
| PWPYZ-150-BZ | BRONZE | DARK BRONZE | 150 |
| PWPYZ-200-BZ | BRONZE | DARK BRONZE | 200 |
| PWPYZ-250-BZ | BRONZE | DARK BRONZE | 250 |
| PWPYZ-C-BZ | BRONZE | CUSTOM | CUSTOM |
| PWPYZ-C-AL | ALUMINUM | CUSTOM | CUSTOM |

BRONZE & ALUMINUM YARDAGE MARKERS



- In Ground Yardage Markers are an essential element of play for any golf course.
- Properly marked courses can speed the pace of play and make for a more enjoyable golf experience.
- Choose background color and yardage numbers you want
- Custom shapes and sizes are available - just call us

| DESCRIPTION | PART NUMBER |
|-----------------------------|-------------|
| 6" ROUND BRONZE | PCMAC-06-BZ |
| 6" ROUND ALUMINUM | PCMAC-06-AL |
| 10" ROUND BRONZE | PCMAC-10-BZ |
| 10" ROUND ALUMINUM | PCMAC-10-AL |
| 6" X 8" BRONZE RECTANGLE | PCMAR-86-BZ |
| 6" X 8" ALUMINUM RECTANGLE | PCMAR-86-AL |
| 8" X 10" BRONZE RECTANGLE | PCMAR-18-BZ |
| 8" X 10" ALUMINUM RECTANGLE | PCMAR-18-AL |

CUSTOMIZE YOUR OWN CAST BRONZE & ALUMINUM YARDAGE MARKERS!



We can create any custom sizes/shape with custom logos on any Cast Bronze and Aluminum yardage markers with multiple finishes available. Call us for more options!

RECYCLED LUMBER ROPE STAKES

- Premium recycled plastic stakes with beveled tops
- Choose speed slot, hole only or metal hook (for chain)
- Available in green, white, brown, or black
- 1.5" square



HUNTER GREEN



WHITE



BLACK



BROWN

12" STAKES

18" STAKES

24" STAKES

36" STAKES



| SIZE | SPEED SLOT | HOLE ONLY | CHAIN HOOK |
|-------------|-----------------|----------------|----------------|
| GREEN- 12" | PWRPS-400-12-SS | PWRPS-400-12-H | PWRPS-400-12-C |
| GREEN - 18" | PWRPS-400-18-SS | PWRPS-400-18-H | PWRPS-400-18-C |
| GREEN- 24" | PWRPS-400-24-SS | PWRPS-400-24-H | PWRPS-400-24-C |
| GREEN - 36" | PWRPS-400-36-SS | PWRPS-400-36-H | PWRPS-400-36-C |
| BLACK- 12" | PWRPS-800-12-SS | PWRPS-800-12-H | PWRPS-800-12-C |
| BLACK - 18" | PWRPS-800-18-SS | PWRPS-800-18-H | PWRPS-800-18-C |
| BLACK- 24" | PWRPS-800-24-SS | PWRPS-800-24-H | PWRPS-800-24-C |
| BLACK - 36" | PWRPS-800-36-SS | PWRPS-800-36-H | PWRPS-800-36-C |
| WHITE- 12" | PWRPS-200-12-SS | PWRPS-200-12-H | PWRPS-200-12-C |
| WHITE - 18" | PWRPS-200-18-SS | PWRPS-200-18-H | PWRPS-200-18-C |
| WHITE- 24" | PWRPS-200-24-SS | PWRPS-200-24-H | PWRPS-200-24-C |
| WHITE - 36" | PWRPS-200-36-SS | PWRPS-200-36-H | PWRPS-200-36-C |
| BROWN- 12" | PWRPS-700-12-SS | PWRPS-700-12-H | PWRPS-700-12-C |
| BROWN - 18" | PWRPS-700-18-SS | PWRPS-700-18-H | PWRPS-700-18-C |
| BROWN- 24" | PWRPS-700-24-SS | PWRPS-700-24-H | PWRPS-700-24-C |
| BROWN - 36" | PWRPS-700-36-SS | PWRPS-700-36-H | PWRPS-700-36-C |

Pricing is subject to change.



ELASTIC CORD ROPE
Deters Coyotes From Cutting Rope

1/4" ELASTIC CORD (500' SPOOL)

- GCAECRGR** GREEN
- GCAECRWH** WHITE
- GCAECRBL** BLACK
- GCAECRGRWH** GREEN/WHITE
- GCAECRYW** YELLOW
- GCAECC** CONNECTOR (100 PACK)- ALUMINUM

PLASTIC CHAIN

Premium Chain Made In The USA



- Chain gives you a different look than rope and can easily be repaired when broken (no splicing rope)
- Wildlife doesn't bite through chain like they do rope
- A better product than the cheap import chains
- U.V.-resistant materials that help us provide a five-year warranty against fading or becoming brittle.
- Made in the U.S.A.
- S-hooks & master links available

- GCAPC1.5-WH** 1.5" X 500' LONG, WHITE
- GCAPC1.5-YW** 1.5" X 500' LONG, YELLOW
- GCAPC1.5-BK** 1.5" X 500' LONG, BLACK
- GCAPC2-WH** 2" X 500' LONG, WHITE
- GCAPC2-YW** 2" X 500' LONG, YELLOW
- GCAPC2-BK** 2" X 500' LONG, BLACK
- GCAPC3-WH** 3" X 300' LONG, WHITE
- GCAPC3-YW** 3" X 300' LONG, YELLOW
- GCAPC3-WBK** 3" X 300' LONG, BLACK

1/4 INCH GOLF COURSE ROPE



- The most common form of traffic control and our most popular rope option
- Use with our rope stakes
- Use the fid to avoid unsightly knots
- 1/4" hollow braid (1000' spool)

- GCARPGR** GREEN
- GCARPWH** WHITE
- GCARPYW** YELLOW
- GCARPGRWH** GREEN/WHITE
- GCARPBLK** BLACK

1/2 INCH GOLF COURSE ROPE



- A thicker rope good to use with our 4" x 4" stakes in areas where it stays up permanently
- Hollow braid allows for fid use to hide any ugly knots
- 1/2" hollow braid (500' spool)

- GCARPGR1/2** GREEN
- GCARPWH1/2** WHITE
- GCARPYW1/2** YELLOW
- GCARPGRWH1/2** GREEN/WHITE
- GCARPBLK1/2** BLACK

RUBBER Mallet



SHPRM2

PLASTIC ROPE FID



- GCARPFID** 1/4" FID
- GCARPFID5** 1/2" FID

30" HAND CRIMPER

For 5/32" 1/4" 5/16" Wire Rope



SHPECCT





TRAFFIC SIGNS

| | |
|-------------|----------------------------------|
| PWALST1212 | YELLOW DIAMOND 12" - ALUMINUM |
| PWALST2424 | YELLOW DIAMOND 24" - ALUMINUM |
| PWALSTOP12 | 12" STOP SIGN - ALUMINUM |
| PWALSTOP18 | 18" STOP SIGN - ALUMINUM |
| PWALSTOP24 | 24" STOP SIGN - ALUMINUM |
| PWPCSTOP-12 | 12" STOP SIGN - LAMINATE PLASTIC |
| PWPCSTOP-18 | 18" STOP SIGN - LAMINATE PLASTIC |
| PWPCSTOP-24 | 24" STOP SIGN - LAMINATE PLASTIC |

*See page 27 for more sign post options.

CART PATH YARDAGE DOTS



| | |
|--------|-------|
| GCAYBR | RED |
| GCAYBW | WHITE |
| GCAYBB | BLUE |

- Use these cart path yardage dots to signify distance from green on the cart path or to mark hazard or ob boundaries on a cart path
- Non-reflective recycled polypropylene material
- install with epoxy resin or butyl pads
- Unique hexagon groove system for improved adhesion and strength
- Available in red, white or blue colors
- Size: 4" diameter x 3/4" tall
- Weight: 2 oz.

CART GUIDES



- Rubber guides attach to path to prevent carts from wearing the edges of turf out on turns
- Low maintenance and effective

FLXCG100 CART GUIDE



GORILLA MAX STRENGTH CLEAR CONSTRUCTION ADHESIVE

9 Ounce Cartridge

- Used to glue cart path guides on hard surfaces

GCAA9T

8" CART TRAFFIC STAKES - 25 STAKES

8" Stake w/ 4" Cap & Transport Bucket



- Easy to use – no rope or chain
- 8 Inch tall stakes with 4 inch long vinyl cap
- Choose from 8 color options
- Stakes come with transport bucket
- Surround irrigation repair or wet areas to prevent carts
- Use along cart paths to prevent wear
- Choose stakes with convenient carrying bucket or without to save money!



| | |
|-------------|------------------------|
| PAR12250-25 | GREEN CAP/WHITE STAKE |
| PAR12252-25 | BLACK CAP/WHITE STAKE |
| PAR12251-25 | RED CAP/WHITE STAKE |
| PAR12253-25 | BLUE CAP/WHITE STAKE |
| PWQS-YB | YELLOW CAP/BLACK STAKE |
| PWQS-BW | WHITE CAP/BLACK STAKE |
| PWQS-WG | WHITE CAP/GREEN STAKE |
| PWQS-WB | WHITE CAP/BROWN STAKE |

Pricing is subject to change.

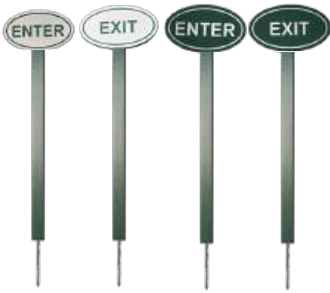

OVAL ENTER/EXIT SIGNS
10" x 7" Sign on 18" Sign Post



OVAL ENTER/EXIT SIGN COLOR OPTION KEY



PWPC-EN18- ENTER SIGN
PWPC-EX18- EXIT SIGN



VERTICAL ENTER/EXIT SIGNS

32" x 3.5"



VERTICAL ENTER/EXIT SIGN COLOR OPTION KEY

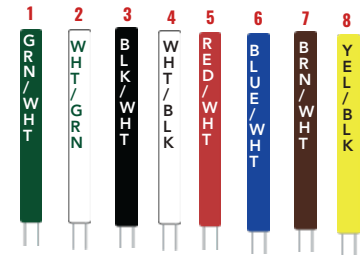

PWPC-EN- ENTER SIGN
PWPC-EX- EXIT SIGN



4" RECYCLED LUMBER TRAFFIC POSTS

- RCPP4412-GN-H 12" GREEN - HOLE
- RCPP4412-GN 12" GREEN - NO HOLE
- RCPP4412-BR-H 12" BROWN - HOLE
- RCPP4412-BR 12" BROWN - NO HOLE
- RCPP4412-BK-H 12" BLACK - HOLE
- RCPP4412-BK 12" BLACK - NO HOLE
- RCPP4418-GN-H 18" GREEN - HOLE
- RCPP4418-GN 18" GREEN - NO HOLE
- RCPP4418-BR-H 18" BROWN - HOLE
- RCPP4418-BR 18" BROWN - NO HOLE
- RCPP4418-BK-H 18" BLACK - HOLE
- RCPP4418-BK 18" BLACK - NO HOLE



- Posts used to divert or block traffic patterns
- Can be used with or without rope
- Comes with double spikes

SCATTER BOARDS

Cart Directional



- Place at the end of cart paths or where carts disperse into the fairways to spread the traffic pattern
- Low maintenance and effective
- Available in green, brown or black
- 48" Wide

- RCPSB48-GN GREEN
- RCPSB48-BR BROWN
- RCPSB48-BK BLACK

Customized with club logo option available

CONVEX SAFETY MIRROR

- Outdoor safety mirror with mounting hardware
- Safety essential for blind corners or can be used for blind tee shots
- Weather proof
- Mounts to wall or post
- Post not included

- GCAMIRROR18 18" DIAMETER
- GCAMIRROR26 26" DIAMETER
- GCAMIRROR36 36" DIAMETER
- GCAMIRROR48 48" DIAMETER

Custom options available.

RUBBER SPEED BUMPS

- Commercial quality rubber speed bump
- Slow carts down on hills or high traffic areas
- Low maintenance
- Sturdy design will not wear out with use

- GCASB4 4 FEET LONG
- GCASB6 6 FEET LONG
- GCASBEC END CAP (ONE END)
- GCASBH MOUNTING HARDWARE



Speed bump pictured with caps



REPLACEMENT WINDSHIELDS



- Folding windshields for all major cart models
- Acrylic
- Clear or tinted options

| CART MODEL MAKE | CLEAR | TINTED |
|------------------------------|-----------|-----------|
| CLUB CAR - PRECEDENT (2004+) | NIV10016 | NIV10017 |
| CLUB CAR - DS (2000+) | NIV6004 | NIV6005 |
| EZ-GO RXV (2008+) | NIV6018 | NIV6019 |
| EZ GO TXT (2014+) | NIV6911 | NIV6912 |
| YAMAHA DRIVE2 (2017+) | NIV09-020 | NIV09-021 |
| YAMAHA G29 (2007-2016) | NIV6014 | NIV6015 |
| YAMAHA G22 (2003, 2007) | NIV6008 | NIV6009 |
| YAMAHA G14 - G19 (1995-2002) | NIV6006 | NIV6007 |

TIRES & WHEELS

- Assemblies are tires mounted on rims with valve stem and fully inflated ready for use.

| PART # | SIZE |
|----------|--|
| NIV10990 | WHEEL ONLY - 8 X 7 CENTER - 4 HOLE - WHITE |
| NIV1608 | WHEEL ONLY- 8 X 7 CENTER - 4 HOLE - BEIGE |
| NIV14546 | 18 X 8.5-8 KENDA HOLE IN ONE TIRE ONLY |
| NIV41061 | 18 X 8.5-8 DURO TIRE ONLY |
| TIR1454A | KENDA TIRE W/ WHEEL MOUNT - WHITE |
| TIR4061A | DURO TIRE W/ WHEEL MOUNT - WHITE |

IGLOO COOLERS & MOUNTING BRACKETS



COOLER ONLY

NIV13784 12 PACK COOLER - BLK

BRACKET & COOLER MOUNTS

NIV13783 UNIVERSAL BRACKET & COOLER

NIV309440 EZ-GO RXV COOLER & MOUNTING BRACKET (2008 & UP)



CLUB CLEAN BLACK CLUB & BALL WASHER



- One plug chamber design allows for easier draining and cleaning
- Includes universal bracket and instructions for easy installation

NIV34141

KENDA
ROUNDED EDGES W/
SAWTOOTH TREAD



DURO
SAWTOOTH
TREAD



FULL PALLET DISCOUNTS & FREE FREIGHT ON TIRES OR ASSEMBLIES

Pricing is subject to change.

REPLACEMENT KEYS

Ez-Go, Clubcar, Yamaha



All keys sold in packs of 25
(Rxv keys sold in sets of 2)

- NIV1919** EZ-GO TXT
- NIV8053** EZ-GO RXV
- NIV1920** CLUBCAR
- NIV1922** YAMAHA

CART IDENTIFICATION FLAGS

Custom Made Messages



- Includes flag, rod and mounting clip
- Clips onto any model of golf cart
- We will make any message you want
- Colors available - red, blue, green, yellow, white

DRECID ANY MESSAGE

TERRY VELOUR GOLF TOWELS

11" X 17" - For Carts



GCATT1117

GOLF CART KEY TAG



- DREKT-BK** BLACK
- DREKT-GR** GREEN
- DREKT-BL** BLUE

UTILITY VEHICLE TOOL RACKS

PLEASE NOTE:

You Must Buy the Receiver Bracket First for Each Item

Step #1 - Order STD27440 (one of each for each bracket you want)

note - Mobile Work Bench Requires Two Of These Brackets

Step #2 - Order brackets you want for your tools

- Outfit your utility vehicle with tool racks for ultimate efficiency
- Easily transport everything you need without damage, noise or losing the capacity of your bed
- Mounts to side and back of most utility vehicles
- Quick disconnect to switch, swap or remove racks when needed
- Universal bracket for ultimate customization

- STD27400** HOSE BRACKET
- STD27500** SMALL TRASH CAN WITH BRACKET - INCLUDES 4 GALLON BUCKET (NOT PICTURED)
- STD27410** HOLE CUTTER BRACKET
- STD27420** MOBILE WORK BENCH
- STD27430** ROPE SPOOL BRACKET
- STD27440** RECEIVER BRACKET - UNIVERSAL BRACKET - MUST BE PURCHASED WITH EACH ABOVE UNIT

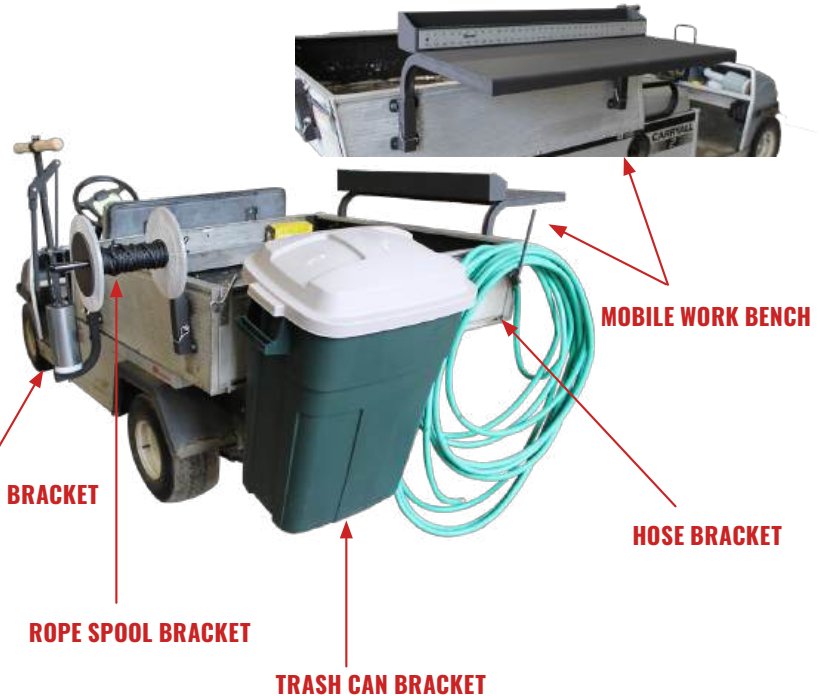

ROPE SPOOL BRACKET

CUP CUTTER BRACKET

MOBILE WORK BENCH

HOSE BRACKET

TRASH CAN BRACKET

CREW CADDY



PAR1038

HOLE CUTTER CARRIER



PAR1011

***EZGO ST350 4-CYCLE DELUXE TUNE UP KIT w/ Oil Filter (Years 1996-Up)**



NIV9306

*We carry tune up kits for all makes and models!

SAFETY GLASSES
Diamondback Style



- SAF540-0201 TINTED
- SAF540-0200 CLEAR
- SAF540-0205 YELLOW

SAFETY GLASSES
Hornets



- SAF5270 CLEAR
- SAF5276 TINTED

DELUXE FACE SHIELD
Replaceable Lens



- SAF5145 FACE SHIELD W/ HEAD GEAR
- SAF5155 REPLACEMENT SHIELD

FULL PROTECTION GLASSES
Meets ANSI Z87.1 & CSA Z94.3

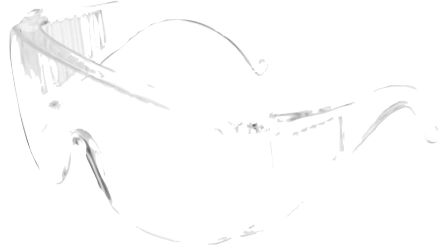

SAF5120

**CHEMICAL SPLASH/IMPACT
RESISTANT GOGGLES**

Anti-Fog, Scratch-Resistant,
Clear Lens, Indirect Venting



SAF53960D

NUISANCE DUST MASK



SAF2985 BOX OF 50

3M PARTICULATE RESPIRATORS
P95 Disposable Masks



SAF8271 BOX OF 10 - P95 - W/ VALVE



FULL RESPIRATOR

DUAL CARTRIDGE RESPIRATOR
Organic Vapor / R95

- Universal nose fit
- Large sealing surface for excellent fit
- Advanced yoke design for a secure comfortable non-slip fit
- Includes: 1-face piece, 2-OV/N99/R95 particulate filters and 2-retainers

REPLACEMENT OV
CARTRIDGE



REPLACEMENT R95 FILTER



SAF311-3215 LARGE RESPIRATOR

REPLACEMENT PARTS

SAF300-1001 OV CARTRIDGE
(PACK OF 6)

SAF300-1070 R 95 FILTERS
(PACK OF 12)

SAF1400-96 MASK WIPES
(CASE OF 100)

Pricing is subject to change.

EAR PLUGS



SAF6100 BOX OF 200

CORDED EAR PLUGS



SAF6101-B BOX OF 100

EAR PLUG DISPENSER



SAF6844 250 COUNT
SAF6845 500 COUNT

EAR MUFFS
NRR 30



SAF6111

**ISOTUNES FREE 2.0 NOISE-ISOLATING
BLUETOOTH EARBUDS**

25 dB NRR



- New & Improved ANSI-certified 25 dB NRR
- New & Improved Bluetooth 5.2
- OSHA Compliant hearing protection
- True wireless technology
- SafeMax™ Technology limits volume output to 85 dB
- Up to 7-hour battery life

SAFIT-73 MATTE BLACK
SAFIT-74 ISO GREEN

**ISOTUNES ISOTUNES XTRA 2.0 NOISE-ISO-
LATING BLUETOOTH EARBUDS**

27 dB NRR



- Magnetic multi-function earbuds
- Redesigned controller with larger, more pronounced buttons
- ANSI-certified 27 dB NRR
- OSHA-compliant hearing protection
- SafeMax™ Technology limits volume output to 85 dB
- Up to 11-hour battery life

SAFIT-27 MATTE BLACK
SAFIT-22 SAFETY YELLOW/BLACK

HARD HAT NECK SHADE



SAF690-1715

**CHAINSAW PROTECTIVE
VISOR AND EAR MUFFS**



SAF7160-73
MOUNTS TO HARD HAT SAF7160-45

FULL BRIM HARD HAT
ANSI Certified



SAF7160-10 WHITE

FRONT BRIM HARD HAT
ANSI Certified



SAF7160-45 WHITE
SAF7160-46 YELLOW

MESH SUN HELMET
Good For Hot Climates



SAFHST

SAFARI GOLF HELMETS



SAFHW WHITE
SAFHT TAN

SIDE VENTED SUN HELMET



- Includes logo at no extra charge
- Minimum order of 16 w/ logo

SAFSHT



ASTRO-GRIP DISPOSABLE GLOVES

Box of 100 Orange Gloves



- 100 gloves per box
- Thickness: 7mil
- Great in wet or dry conditions
- Powder-free exam grade nitrile
- Dual-sided cube grip

SAF66472 MEDIUM
 SAF66473 LARGE
 SAF66474 XL

RAVEN DISPOSABLE GLOVES

Box of 100 Black Gloves



- 100 gloves per box
- Thickness: 6mil
- Outstanding strength, wear and dexterity
- Comfortable for wear
- Textured for excellent chemical resistance and great grip
- Latex and powder free

SAF66517 MEDIUM
 SAF66518 LARGE
 SAF66519 XL

LINED LEATHER GLOVES



- Great for cold weather outdoor work
- Withstands moisture
- Soft pigskin lined with fleece

SAFGLDL-M MEDIUM
 SAFGLDL-L LARGE

LEATHER DRIVER'S GLOVES



- Great for equipment operators
- Good balance of protection and dexterity
- Cowhide leather

SAFGLD-M MEDIUM
 SAFGLD-L LARGE

LEATHER PALM GLOVE WITH SAFETY CUFF



SAFGLLP ONE SIZE FITS ALL

MAXIFLEX GLOVES

Protection & Flexibility



- Micro-foam nitrile coatings are compatible with light oils and will provide a good grip and excellent abrasion resistance
- Form, fit and feel - mimics the "hand at rest", reducing hand fatigue and increasing comfort

SAFGLJM-M MEDIUM
 SAFGLJM-L LARGE
 SAFGLJM-XL XL

MECHANIC'S GLOVES



- Excellent dexterity and flexibility for intricate work
- Outstanding gripping power
- Great protection against blisters, cuts and abrasions
- Stretch top for great flexibility and ease of movement
- Machine washable

SAF6652 MEDIUM
 SAF6653 LARGE
 SAF6654 XL
 SAF6655 XXL

KEVLAR CHAINSAW GLOVES



- Foam padding on palms reduces vibrations
- Features 2 layers of Kevlar for cut resistance/protection
- 100% goatskin leather on palm for firm grip
- Reinforced fingertips and knuckles for durability

ECH99988801600 MEDIUM
 ECH99988801601 LARGE
 ECH99988801602 XL
 ECH99988801603 XXL

NITRILE CHEMICAL GLOVES



- Premium unsupported nitrile
- 15-Mil, green
- Unlined
- Embossed grip

SAFGLC - 9 **SIZE 9**
SAFGLC - 10 **SIZE 10**

CHEMICAL MIXING APRON



- Excellent splash protection against most mild chemicals
- Adjustable neckstrap
- 100% waterproof
- Longer length extends coverage (35" W x 47" L)
- One size fits most

SAF6821 **APRON**

TYVEK SPRAY SUITS
400 Series Coveralls



MEASURING CUP SET



IRRMSET **5 CUP COMPLETE SET**
IRRM8 **8 OZ MEASURING CUP**
IRRM16 **16 OZ MEASURING CUP**
IRRM32 **32 OZ MEASURING CUP**
IRRM64 **64 OZ MEASURING CUP**
IRRM128 **128 OZ MEASURING CUP**

PVC GLOVE



- 14" length
- Double-dip anti-slip rough finish
- Specially formulated for solvents such as lacquer thinner and parts wash solutions
- Knit interlock liner

SAF6553- LARGE

120 Series

- Open wrists & ankles
- No hood
- Case of 25 suits

122 Series

- Elastic wrists & ankles
- With hood
- Case of 25 suits

125 Series

- Elastic wrists & ankles
- No hood
- Case of 25 suits

HAZARDOUS MATERIALS DIAMOND SIGNS

OSHA Compliant



- Complete kit available on a 12" x 12" Aluminum sign or as a vinyl decal kit
- Each kit comes with 3 of each number 0-4 and 1 of each word/symbol - oxy, alk, acid, W

PWALS1212-205 **12" ALUMINUM SIGN KIT**

PWVL-NUM **NUMBER & SYMBOL KIT ONLY**

SAFTY120-M **MEDIUM**
SAFTY120-L **LARGE**
SAFTY120-XL **XL**
SAFTY120-2X **2 XL**
SAFTY120-3X **3 XL**
SAFTY120-4X **4 XL**
SAFTY122-M **MEDIUM**
SAFTY122-L **LARGE**
SAFTY122-XL **XL**
SAFTY122-2XL **2XL**
SAFTY125-M **MEDIUM**
SAFTY125-L **LARGE**
SAFTY125-XL **XL**
SAFTY125-2X **2 XL**
SAFTY125-3X **3 XL**
SAFTY125-4X **4 XL**



PORTABLE EYE WASH STATION



- One-hand operation
- Gravity fed, no plumbing required
- Holds 9 gallons of water
- 15-minute flow time
- Measures: 9.5" x 16.5" x 20.15"
- Includes: mounting bracket, inspection tag and preservative
- Change water every 90 days

SAF5134-00 EYEWASH STATION

EYEWASH SOLUTION STATION



- Temporary first-aid
- Great for spray rigs
- Durable plastic station includes 2-16 oz. bottles
- Bottles have twist-off tops with protective seals
- Directions printed on station for fast reference

SAF5132 EYEWASH SOLUTION STATION

SAF5130 REPLACEMENT SOLUTION

OUTDOOR SAFETY SELF DRAINING SHOWER W/ Open Eye Wash



- Use outdoors, in warm climates with a maximum ambient operating temperature of 113°F (45°C) or below
- Self-draining valve allows standing water to drain away from the standpipe ensuring the delivery of tepid water
- Includes a universal safety shower sign for enhanced visibility
- Meets ANSI Z358.1 2014 and EN 15154 standards, supports OSHA requirements

SAFSD18G85G GALVANIZED STATION

SAFSD18GS85G STAINLESS STEEL STATION

INDUSTRIAL FIRST AID KIT Metal Case



SAF6025-01 25 PERSON

SAF6050-01 50 PERSON

DELUXE KNEE PADS Plastic Cap Over Tough Nylon Fabric



SAF7102

BACK SUPPORT BELT

4 Plastic Stays for Flexible, Contoured Support



SAF7161 SMALL (26"-32")

SAF7162 MEDIUM (32"-38")

SAF7163 LARGE (38"-47")

SAF7164 XL (46"-56")

SAF7165 XXL (54"-58")

GREENKEEPER LED HEADLAMP

Rechargeable With Zoom Feature



SHPHLR HEADLAMP

Pricing is subject to change.



KUJO YARD SHOE

Water Resistant Design For A Superintendent

- PWKYS-GG-** GRAY/GREEN
- PWKYS-DS-** DESERT SAND
- PWKYS-BG-** BLACK/GREEN



GREY & GREEN



DESERT SAND



BLACK & GREEN

See size chart below for available options.

KUJO SURGE RUBBER BOOT

Water Resistant Design For A Superintendent



Introducing the Kujo Surge Rubber Boot – your ultimate ally against wet, slippery, and challenging terrains! Engineered for durability and comfort, these boots are 100% waterproof with a slip-resistant Turf-Grip outsole for unbeatable traction.

PWKRB-G-**

KUJO JAX

Water Resistant Pull-On Shoes

- PWKJS-BG-** BLACK & GREY
- PWKJS-GB-** GREY & BLUE



BLACK & GREY



GREY & BLUE

**ADD SIZE AFTER PART #.
SIZE 5, 5.5, 6, 6.5 NOT
AVAILABLE FOR BOOTS.**

| | |
|----------|-----------|
| SIZE 5 | SIZE 10 |
| SIZE 5.5 | SIZE 10.5 |
| SIZE 6 | SIZE 11 |
| SIZE 6.5 | SIZE 11.5 |
| SIZE 7 | SIZE 12 |
| SIZE 7.5 | SIZE 13 |
| SIZE 8 | SIZE 14 |
| SIZE 8.5 | |

KUJO X1 LANDSCAPE BOOT

Water Resistance & Safety

- PWKYB-B-** BLACK
- PWKYB-DS-** DESERT SAND



DESERT SAND



GREY & GREEN



KUJO X4S WATERPROOF BOOT

Water Resistance & Safety

Experience year-round performance with these lightweight, soft-toe work shoes designed for comfort and durability. Featuring a waterproof liner, durable ripstop upper, and a rugged rubber turf grip outsole, they provide superior protection and support for any task.



PWKRB-G-**

ADD SIZE AFTER PART #.
SIZE 5, 5.5, 6, 6.5 NOT AVAILABLE FOR BOOTS.

- SIZE 5 SIZE 10
- SIZE 5.5 SIZE 10.5
- SIZE 6 SIZE 11
- SIZE 6.5 SIZE 11.5
- SIZE 7 SIZE 12
- SIZE 7.5 SIZE 13
- SIZE 8 SIZE 14
- SIZE 8.5

KUJO YARD PANTS

Hardworking, Flexible, And Comfortable Yard Work Apparel

Discover the perfect blend of comfort, durability, and functionality with Kujo Yard Pants. Designed for the hardworking individual, these pants are your ultimate companion for all outdoor activities. Experience unparalleled breathability with our patented air mesh behind the calves, keeping you cool even during the most demanding tasks.

PWKP90020** CHARCOAL PANTS

PWKP90010** DESERT SAND PANTS



CHARCOAL PANTS



DESERT SAND PANTS

SIZES AVAILABLE

- 30" X 30"
- 32" X 30"
- 32" X 32"
- 34" X 30"
- 34" X 32"
- 34" X 34"
- 36" X 32"
- 36" X 34"
- 38" X 32"
- 40" X 32"

KUJO YARD SHORTS

Hardworking, Flexible, And Comfortable Yard Work Apparel

Transform your outdoor experience with Kujo Yard Shorts – the ultimate fusion of durability, comfort, and practicality. Engineered from high-performance double-stitched ripstop fabric, these shorts are built to withstand any challenge you throw their way. With a flexible 4-way stretch and gusseted crotch, they ensure unrestricted movement, making every task in the yard a breeze.



GREY SHORTS



DESERT SAND SHORTS

SIZES AVAILABLE

- 30"
- 32"
- 34"
- 36"
- 38"
- 40"

PWKP90020** GREY SHORTS

PWKS91010** DESERT SAND SHORTS

Pricing is subject to change.

HELLY HANSEN MANDAL

Rain Bib



- En 343 3,1 waterproof
- 100% Polyester waterproof fabric and construction
- Inner chest pocket with zipper
- Adjustable elastic suspenders

| | |
|-----------------------|--------------------|
| SAF70529-480S | GREEN - SM |
| SAF70529-480M | GREEN - MD |
| SAF70529-480L | GREEN - LG |
| SAF70529-480XL | GREEN - XL |
| SAF70529-4802X | GREEN - 2X |
| SAF70529-4803X | GREEN - 3X |
| SAF70529-310S | YELLOW - SM |
| SAF70529-310M | YELLOW - MD |
| SAF70529-310L | YELLOW - LG |
| SAF70529-310XL | YELLOW - XL |
| SAF70529-3102X | YELLOW - 2X |
| SAF70529-3103X | YELLOW - 3X |

HELLY HANSEN MANDAL

Rain Jacket



- En 343 3,1 waterproof
- 100% Polyester PVC coated waterproof fabric
- Hood with draw cord adjustment
- Storm flap & two hand pockets

| | |
|-----------------------|--------------------|
| SAF70129-480S | GREEN - SM |
| SAF70129-480M | GREEN - MD |
| SAF70129-480L | GREEN - LG |
| SAF70129-480XL | GREEN - XL |
| SAF70129-4802X | GREEN - 2X |
| SAF70129-4803X | GREEN - 3X |
| SAF70129-310S | YELLOW - SM |
| SAF70129-310M | YELLOW - MD |
| SAF70129-310L | YELLOW - LG |
| SAF70129-310XL | YELLOW - XL |
| SAF70129-3102X | YELLOW - 2X |
| SAF70129-3103X | YELLOW - 3X |

HELLY HANSEN MANDAL

Pants



- En 343 3,1 waterproof
- 100% Polyester, pvc coated waterproof fabric
- Elastic at waist
- Push button adjustment at hem & waist

| | |
|-----------------------|--------------------|
| SAF70429-480S | GREEN - SM |
| SAF70429-480M | GREEN - MD |
| SAF70429-480L | GREEN - LG |
| SAF70429-480XL | GREEN - XL |
| SAF70429-4802X | GREEN - 2X |
| SAF70429-4803X | GREEN - 3X |
| SAF70429-310S | YELLOW - SM |
| SAF70429-310M | YELLOW - MD |
| SAF70429-310L | YELLOW - LG |
| SAF70429-310XL | YELLOW - XL |
| SAF70429-3102X | YELLOW - 2X |
| SAF70429-3103X | YELLOW - 3X |

CHEST WADERS



- Built-in belt loops with adjustable belt
- Excellent cold weather flexibility
- Durable, heavy duty nylon PVC upper with polyester backing
- Adjustable polyester nylon strap
- Top drawstring closure for snug fit
- Non-absorbent lining
- 35% lighter most chest waders

| PART # | SHOE SIZE |
|---------------------|-----------|
| SAF860660900 | 9 |
| SAF860661000 | 10 |
| SAF860661100 | 11 |
| SAF860661200 | 12 |
| SAF860661300 | 13 |

PVC KNEE BOOTS

Profile Plain & Safety Toe Options

| | PLAIN - | SIZE | SAFETY - | SIZE |
|--|-------------------|-----------|-------------------|-----------|
|  | SAF511546 | 6 | SAF512546 | 6 |
| | SAF511547 | 7 | SAF512547 | 7 |
| | SAF511548 | 8 | SAF512548 | 8 |
| | SAF511549 | 9 | SAF512549 | 9 |
| | SAF5115410 | 10 | SAF5125410 | 10 |
| | SAF5115411 | 11 | SAF5125411 | 11 |
| | SAF5115412 | 12 | SAF5125412 | 12 |
| | SAF5115413 | 13 | SAF5125413 | 13 |

- 100% liquid proof
- 15" Ht. with a cutline at 12" to facilitate fast and clean height modification
- Outsole material is soft for excellent slip resistance and absorbs shock when walking
- Cleated outsole spits out debris for excellent gripping action on various surfaces
- Steel toe available- special order



STORM CHAMP RAIN SUITS

Includes Pants & Jacket



- 2-Piece suit made of .20mm PVC on nylon
- Lightweight, soft and generously cut
- Zipper front jacket, hook & loop take-up straps
- Plain front waist pants; pockets

| | |
|----------------------|--------------------|
| SAFS66211-MD | BLUE - MD |
| SAFS66211-LG | BLUE - LG |
| SAFS66211-XL | BLUE - XL |
| SAFS66211-XXL | BLUE - XXL |
| SAFS66218-MD | GREEN - MD |
| SAFS66218-LG | GREEN - LG |
| SAFS66218-XL | GREEN - XL |
| SAFS66218-XXL | GREEN - XXL |

SUNSCREEN

1 Gallon With Pump

- SPF 50
- Contains vitamins which UVA/ UVB Broad Spectrum Protection and shield skin against harmful damage from both UVA and UVB rays.
- Proudly made in USA, Chemical-Free, Paraben-Free Preservative System and fast-absorbing



SAFSS1G

GOJO HAND CLEANER

- Gojo natural orange pumice hand cleaner contains quick-acting lotion formula with pumice scrubbing particles
- Cleans a broad range of industrial soils, medium dirt and grease
- Orange citrus scent
- Natural citrus ingredients



SHP752-940 1/2 GAL DISPENSER

SHP752-944 1 GAL DISPENSER

TINGLEY OVERSHOES

Wider Fit For Boots



- Enlarged sizing for the bulkiest of work shoes and boots.
- 100% waterproof protection.
- Will not crack or stiffen in the coldest of weather.
- Deep cleated outsole spits out debris for good slip resistance and longer wear.
- Comes packed in box

| | |
|------------------|---------------|
| SAF1300M | MEDIUM |
| SAF1300L | LARGE |
| SAF1300XL | XL |

TINGLEY OVERSHOES

Classic Fit



- Classic sizing best for sneakers and work shoes
- 100% waterproof protection.
- Will not crack or stiffen in the coldest of weather.
- Deep cleated outsole spits out debris for good slip resistance and longer wear.
- Comes packed in a bag

| | |
|------------------|---------------|
| SAF2300S | SMALL |
| SAF2300M | MEDIUM |
| SAF2300L | LARGE |
| SAF2300XL | XL |
| SAF2300G | XXL |

CHAINSAW CHAPS



ECH99988801302

36" FULL WRAP CHAINSAW CHAPS
THIS SIZE FITS WAISTS 30" - 42"

FEATHERWEIGHT 3/4" & 1" ULTRAMAX HOSE

For The Professional Turf Manager



**ONLY WEIGHS
15 LBS!**



3/4" HOSE PART # 1" HOSE PART #

| | | |
|----------|---------------------|---------------------|
| 50 FEET | IRRH75-050FW | IRRH10-050FW |
| 75 FEET | IRRH75-075FW | IRRH10-075FW |
| 100 FEET | IRRH75-100FW | IRRH10-100FW |
| 125 FEET | IRRH75-125FW | IRRH10-125FW |

FEATHERWEIGHT 3/4" PROLINE HOSE



**ONLY WEIGHS
9 LBS!**



| | |
|-------------------------|-----------------|
| IRRH75-050PRO-FW | 3/4" X 50 FEET |
| IRRH75-075PRO-FW | 3/4" X 75 FEET |
| IRRH75-100PRO-FW | 3/4" X 100 FEET |

ULTRAMAX RED HOSE

Abrasive Resistant, Heavy Duty

SUPER STRONG



- 800 psi burst pressure rating
- Heavy duty, long lasting
- Abrasive resistant
- Holds up to dragging

| | |
|--------------------|-------------|
| IRRH75-025R | 3/4" X 25' |
| IRRH75-050R | 3/4" X 50' |
| IRRH75-075R | 3/4" X 75' |
| IRRH75-100R | 3/4" X 100' |
| IRRH75-125R | 3/4" X 125' |
| IRRH10-050R | 1" X 50' |
| IRRH10-075R | 1" X 75' |
| IRRH10-100R | 1" X 100' |
| IRRH10-125R | 1" X 125' |

ULTRAMAX BLUE HOSE

Our Best Hose

PREMIUM



- 1200 psi burst pressure rating
- Ultra flexible
- Lightweight - 45% lighter than other professional, heavy duty hoses
- Smooth finish

| | |
|--------------------|-------------------|
| IRRH75-S10 | 3/4" X 10' SHORTY |
| IRRH75-S20 | 3/4" X 20' SHORTY |
| IRRH75-050B | 3/4" X 50' |
| IRRH75-075B | 3/4" X 75' |
| IRRH75-100B | 3/4" X 100' |
| IRRH75-125B | 3/4" X 125' |
| IRRH10-S10 | 1" X 10' SHORTY |
| IRRH10-S20 | 1" X 20' SHORTY |
| IRRH10-050B | 1" X 50' |
| IRRH10-075B | 1" X 75' |
| IRRH10-100B | 1" X 100' |
| IRRH10-125B | 1" X 125' |

ULTRAMAX GREEN HOSE

800 PSI, Tough Outer Wall

ECONOMY-PLUS



- 800 psi burst pressure rating
- Very smooth finish
- Lightweight

| | |
|--------------------|-------------|
| IRRH75-050G | 3/4" X 50' |
| IRRH75-075G | 3/4" X 75' |
| IRRH75-100G | 3/4" X 100' |
| IRRH75-125G | 3/4" X 125' |
| IRRH10-050G | 1" X 50' |
| IRRH10-075G | 1" X 75' |
| IRRH10-100G | 1" X 100' |

ULTRAMAX CLEAR HOSE

Lightweight & Economical



| | |
|--------------------|-------------|
| IRRH75-050C | 3/4" X 50' |
| IRRH75-075C | 3/4" X 75' |
| IRRH75-100C | 3/4" X 100' |
| IRRH75-125C | 3/4" X 125' |
| IRRH10-50C | 1" X 50' |
| IRRH10-75C | 1" X 75' |
| IRRH10-100C | 1" X 100' |
| IRRH10-125C | 1" X 125' |

PROLINE FLEX FABRIC HOSE

Commercial Grade Quality Hose

NEW PRODUCT!



- 600 psi Burst / 300 psi Operating
- Lightweight, easy to maneuver, easy to store
- Maintains flow even if kinked
- 3/4 inch inner diameter for higher flow rates
- Abrasion resistant

| | |
|---------------------------|-------------|
| IRRH75-050PRO-FLEX | 3/4" X 50' |
| IRRH75-075PRO-FLEX | 3/4" X 75' |
| IRRH75-100PRO-FLEX | 3/4" X 100' |

PROLINE PURPLE SERIES HOSE

Economical Multi-Purpose Hose



- Economical multi-purpose hose solution with the same construction specifications as our popular Proline Gold Series hose.
- 500 psi Burst Pressure
- ZERO-KINK technology
- Machined Brass couplings
- Lightweight and durable
- 20.2 lbs. (9.2kg)

| | |
|------------------------|-----------------------------|
| IRRH75-050PRO-P | 3/4" X 50' |
| IRRH75-075PRO-P | 3/4" X 75' |
| IRRH75-100PRO-P | 3/4" X 100' |
| PWALS1218-101 | 12"X18" RECYCLED WATER SIGN |

PROLINE GOLD SERIES HOSE



| | |
|------------------------|-------------|
| IRRH75-050PRO-G | 3/4" X 50' |
| IRRH75-075PRO-G | 3/4" X 75' |
| IRRH75-100PRO-G | 3/4" X 100' |

HOSE CADDIE™ & HOSE CADDIE™ TRAILER

- Strongest Durable Hose Trailer on the Market
- Packaged for Minimal Shipping Expense
- Full Size Golf Cart Tires & Hubs
- 10' Leader Hose Included ONLY*
- Replacement Parts Available
- Includes Convenient Quick Coupler Key Mount
- Optional Steel Tool Box Available

Underhill



HOSE CADDIE™ TRAILER



HOSE CADDIE™

*Premium long hoses are not included with purchase. See hose options on page 125

- IRRHC-TRL-075** ¾" MODEL W/TRAILER
- IRRHC-TRL-100** 1" MODEL W/TRAILER
- IRRHC-075** ¾" MODEL CADDIE ONLY
- IRRHC-100** 1" MODEL CADDIE ONLY



Underhill

POWER-SPLITTER 2-Way Hose Tap Splitter



- 2-Way Hose Tap Splitter
- Large brass ergonomic handles for easy flow control
- Full size golf cart tires & hubs
- Larger ports allow for full flow rates over 30 gpm
- All brass & stainless steel construction for ultimate durability

IRRA-HB2HF

Underhill

TWIST-EASE KINK ELIMINATOR Irrigation Hose Swivel



NEVER FIGHT WITH A TANGLED HOSE AGAIN!

- IRRHSF-75** ¾" KINK ELIMINATOR
- IRRHSF-100** 1" KINK ELIMINATOR

BANDIT

Hose Repair Tool



- Used to apply BAND-IT 3/8" and 5/8" Center Punch Clamps
- Ratchet the clamp tight and hit with a hammer to secure clamp

IRRB1

FAST-LOK CLAMP TOOL



- Used to apply BAND-IT 3/8" and 5/8" Center Punch Clamps
- Ratchet the clamp tight and hit with a hammer to secure clamp

IRRF38

HOSE WORM CLAMPS



- IRRHWC-050-125** 1/2" - 1.25" OD
- IRRHWC-075-175** 3/4" - 1.75" OD

STAINLESS STEEL BANDS

Used for Clamp Tools



- IRRSHC5/8** 5/8" STAINLESS BAND
- IRRSHC3/8** 3/8" STAINLESS BAND

QUICK COUPLER VALVES

One Piece With Rubber Top



3/4" VALVE 1" VALVE 1.5" VALVE

- Red Brass
 - Interchanges with Rain Bird, Toro, Hunter & Buckner
 - Stainless Steel Accessories
 - Spring Loaded Vinyl Covers
- IRRQV-075** 3/4" VALVE
IRRQV-100 1" VALVE
IRRQV-150 1.5" VALVE

QUICK COUPLER VALVES

Two Piece w/ Rubber Top



1.5" VALVE 1" VALVE

- Red Brass
 - Interchanges with Rain Bird, Toro, Hunter & Buckner
 - Stainless Steel Accessories
 - Spring Loaded Vinyl Covers
- IRRQV-075-2P** 3/4" VALVE
IRRQV-100-2P 1" VALVE



| SINGLE PIECE BODY - BRASS KEY COUPLERS | | CROSS REFERENCE CHART | | | |
|--|---|-----------------------|-----------|-----------|--------|
| UNDERHILL MODEL NO. | DESCRIPTION | BUCKNER | RAIN BIRD | TORO | HUNTER |
| IRRQV-075 | 3/4" QUICK COUPLER W/ YELLOW RUBBER COVER | QCV075R | 3RC | 473-01 | N/A |
| IRRQV-100 | 1" QUICK COUPLER W/ YELLOW RUBBER COVER | QCV0100R | 33DRC | 473-21 | N/A |
| IRRQV-150 | 1.5" QUICK COUPLER W/ YELLOW RUBBER COVER | QCV0151R | N/A | 476-01 | N/A |
| TWO- PIECE BODY - BRASS KEY COUPLERS | | CROSS REFERENCE CHART | | | |
| UNDERHILL MODEL NO. | DESCRIPTION | BUCKNER | RAIN BIRD | TORO | HUNTER |
| IRRQV-075-2P | 3/4" QUICK COUPLER W/ YELLOW RUBBER COVER | QB33RC07 | 44KA | N/A | N/A |
| IRRQV-100-2P | 1" QUICK COUPLER W/ YELLOW RUBBER COVER | QB44RC10 | 44-RC | 100-2SLVC | HQ-44 |

THE CLAW

Prevents quick couplers from turning when using the quick coupler key

IRRQCA-075100
3/4" and 1" valves

IRRQCA-150
1 1/2" valves

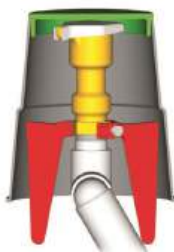

EASY RETROFIT! Installs Without Removing Valve or Valve Box - Fits in 6" Round Box or Larger!

REPLACEMENT O-RINGS

Sprinkler Internal O-Rings



- IRRROR-100** 1" INLET TORO OR RAINBIRD 700 SERIES
IRRROR-150 1.5" INLET TORO HEADS
IRRROR-150RB 1.5" INLET RAINBIRD HEADS



UNDERHILL HOSE TAP

Rainbird Or Toro Adapters

- Convert any head into a quick coupler
- Choose sizes for Toro or Rainbird heads
- Easy to use, just pull internal and insert hose tap



IRRHN-T150S



IRRHN-T150S

- IRRHN-T100** TORO 1" INLET HEADS W/OUT SWIVEL
IRRHN-T100S TORO 1" INLET HEADS WITH SWIVEL
IRRHN-T150 TORO 1.5" INLET HEADS W/OUT SWIVEL
IRRHN-T150S TORO 1.5" INLET HEADS WITH SWIVEL
IRRHN-R125 RAINBIRD W/OUT SWIVEL
IRRHN-R125S RAINBIRD WITH SWIVEL
IRRHN-R150 RAINBIRD 900 SERIES W/OUT SWIVEL
IRRHN-R150S RAINBIRD 900 SERIES W/ SWIVEL

SPRINKLER HEAD HOSE TAP ADAPTERS

Rainbird Or Toro Adapters

- Convert any head into a quick coupler
- Choose sizes for Toro or Rainbird heads
- Stainless steel reinforced PVC hose swivels 360 degrees even under pressure

- IRRUSR-2-FL** TORO 750/850 SERIES X 1 NPSH
IRRUSR-3-FL RAINBIRD 700 SERIES X 1 NPSH
IRRUSR-4-FL RAINBIRD 900 SERIES X 1 NPSH



IRRUSR-2-FL



IRRUSR-3-FL



IRRUSR-4-FL



QUICK COUPLER KEY SINGLE LUG



- Single lug key
- Rainbird 33 or toro 473 valve compatible
- 3/4" top mpt
- Swivel sold separately

IRRQK-075

QUICK COUPLER KEY SINGLE LUG



OUR MOST POPULAR

- Single lug key
- Rainbird 44 or toro 474 valve compatible
- 1" top mpt
- Swivel sold separately

IRRQK-100

SINGLE LUG QUICK COUPLER KEY



- Single lug key
- Rainbird 77 or toro 476 compatible
- 1.5" top mpt x 1.5" bottom
- Swivel sold separately

IRRQK-150

ACME QUICK COUPLER KEY



- Acme thread key
- Toro 474 or rainbird 4k-acme compatible
- 1" top mpt
- Swivel sold separately

IRRQB44KAT10

DOUBLE LUG QUICK COUPLER KEY

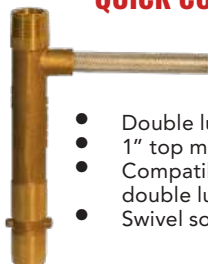

- Double lug key
- 1" top mpt
- Compatible w/ buckner double lug valves
- Swivel sold separately

IRRQB55K10

RAINBIRD 55K QUICK COUPLER KEY



- Single lug key
- Rainbird 55 or toro 475 valve compatible
- 1" top mpt
- Swivel sold separately

IRRRB55K

| BRASS QUICK COUPLER KEYS (SINGLE LUG) | | CROSS REFERENCE CHART | | | |
|---------------------------------------|-------------------------------------|-----------------------|-----------|--------|--------|
| UNDERHILL MODEL NO. | DESCRIPTION | BUCKNER | RAIN BIRD | TORO | HUNTER |
| IRRQK-075 | 3/4" MPT X 1/2" FPT KEY | Q33K07 | 33DK | 463-01 | N/A |
| IRRQK-100 | 1" MPT X 3/4" FPT KEY | QB44K10 | 44K | 464-01 | HK-44 |
| QK-125 | 1" MPT X 3/4" FPT KEY | QB5RK10 | 55K | 465-01 | N/A |
| QK-150 | 1 1/2" MPT X 1 1/4" FPT KEY | N/A | N/A | N/A | N/A |
| QK-150RBTB | 1 1/2" MPT X 1 1/4" FPT KEY | QC151 | 7K | 466-01 | N/A |
| QK-100AT | 1" MPT X 3/4" FPT ACME THREADED KEY | QB44KAT10 | 44KA | 464-03 | HK-44 |

THE EXTENDER

Quick Coupler Key Extender for Low Valves



Now finally a solution for buried Quick Coupler Valves with difficult to open keys. No more having to dig up and raise the valve to make the key operational.

- Three models available to extend any Quick Coupler Key – 3/4", 1", and 1 1/2"
- The Extender raises the Quick Coupler Key an additional 4"
- Solid Brass with built-in handle

IRRQK-075EX 3/4" FPT X 3/4" MPT

IRRQK-100EX 1" FPT X 1" MPT

IRRQK-150EX 1.5" FPT X 1.5" MPT

HOSE SWIVELS



IRRHHS-075 3/4" FPT X 3/4" MHT

IRRHHS-100 1" FPT X 3/4" MHT

IRRHHS-101 1" FPT X 1" MHT

IRRHHS-151 1 1/2" FPT X 1" MHT

Pricing is subject to change.

NEW PRODUCT!



HOSEHEAD

For Bear or Toro Sprinklers

Economical all-in-one hose adapter for BEAR and TORO sprinklers with 360 degree swivel action.

- IRRHS-013** 1" INLET SPRINKLER, 3/4" SWIVEL
- IRRHS-014** 1" INLET SPRINKLER, 1" SWIVEL
- IRRHS-015** 1.5" INLET SPRINKLER, 3/4" SWIVEL
- IRRHS-016** 1.5" INLET SPRINKLER, 1" SWIVEL
- IRRHS-017** 1" HOSE THREAD FOR G90 SPRINKLERS

REPLACEMENT O-RINGS

Sprinkler Internal O-Rings



- IRROR-100** 1" INLET TORO OR RAINBIRD 700 SERIES
- IRROR-150** 1.5" INLET TORO HEADS
- IRROR-150RB** 1.5" INLET RAINBIRD HEADS

EZ REACH KEYS



- Extra long and extra heavy duty metal key designed for easy on/off operation for Toro, Rainbird and John Deere/Signature electric valve-in-head golf sprinklers.
- Made of high grade metal, EasyReach offers years of effortless on/off operation.

- IRRA-ERR** RAINBIRD KEY
- IRRA-ERT** TORO KEY

PELLET PRO

Quick Coupler Mount

- Pellet pro threads directly to quick coupler
- Inject while using spot sprinklers or your favorite hose nozzle
- Fits 3/4" hoses
- 1" adapters available for 1" swivels and hoses.



- IRRA-PPQ-075** 3/4" FHT INLET IN-LINE APPLICATOR
- IRRA-PPQ-100** 1" FHT INLET IN-LINE APPLICATOR
- IRRA-PPBG** BOWL BUNA GASKET
- IRRA-PPBK** BOWL W/ GASKET
- IRRA-PPB** BOWL ONLY (NO GASKET)
- IRRA-BA107FM** HOSE ADAPTER, 1" FHT TO 3/4" MHT

SUPERKEY

Fits All Brands & Has Common Tools



- Effortlessly turns electric valve-in-heads on and off, removes internal snap rings and performs many other sprinkler maintenance chores.
- Great for John Deere®/Signature® sprinklers too!

IRRA-SKTRB

DYNAMIC WATER PRESSURE GAUGE



- This is the ideal tool for checking actual working water pressure versus static pressure
- There are many practical uses for this new specially designed gauge package
- Pressure range up to 160PSI.
- Measures both Dynamic and Static pressure
- Comes in 1 inch or 3/4 inch
- Solid brass construction

IRRA-HPG-075 3/4" FHT X 3/4" MHT

IRRA-HPG-100 1" FHT X 1" MHT

21 INCH IRRIGATION MARKING FLAGS (Bundle Of 100)



IRRMF21YW YELLOW

IRRMF21BU BLUE

IRRMF21WH WHITE

IRRMF21RD RED

IRRMF21OR ORANGE

IRRMF21PK PINK

FLAG SIZE 4" X 5"
21" TALL

SPECIALTY USE PRESSURE CHECKERS



- Nozzle discharge pressure gauges & adapters
- Use these liquid-filled 160 PSI gauge with 30" Flex hose and solid brass pitot tube, hose bib, or spray head and Schrader adapters to measure water pressure at discharge points.



IRRA-PHG-160K GAUGE AND 30" FLEX HOSE WITH PITOT TUBE

IRRA-HCGPK GAUGE AND PITOT TUBE

IRRA-HCP PITOT TUBE ONLY

IRRA-SV-160K GAUGE WITH SCHRADER VALVE ADAPTER

IRRA-SHG-160K GAUGE WITH SPRAY HEAD ADAPTER

CATCH CAN ULTRA Package Of 12



- Self standing - easily anchors into turf, even on slopes
- Measures sprinkler application in inches or centimeters
- Unique design allows for shorter duration test
- Made of durable polypropylene engineered plastic
- Can be stacked for easy storage and transport
- Each 12 Pack Kit (comes with instructions)

IRRCCUPK-12 12 PACK

Pricing is subject to change.



AUDITMASTER IRRIGATION EFFICIENCY TESTING KIT

EXPERT Sprinkler Performance Testing PRO Kits

Increasing watering times to compensate for poorly performing sprinklers wastes a lot of water. Accurately measuring sprinkler application rates with Underhill® AuditMaster™ helps maximize water savings.



KIT INCLUDES:

- 36 CatchCan Ultras
- Pressure Checker with Gauge/Hose/Pitot Tube
- Pressure Checker with Gauge/Hose/Schrader Valve
- Pressure Checker with Spray Head Adapter
- Hose Bib Tap
- Stop Watch
- Anemometer Wind Gauge
- 100 Foot Measuring Tape
- 50 Marking Flags
- Wheeled Carry Case

IRRAUD-LT COMPLETE KIT

PLASTIC HIGH FLOW SHUT OFF



IRRA-BV77FM PLASTIC SHUT OFF

BRASS HIGH FLOW SHUT OFF



**IRRCV075H BRASS SHUT OFF
3/4" INLET**

HOSE REPAIR AND ADAPTER FITTINGS



- | | | |
|----|----------------------|---|
| 1 | IRRA-BA107FM | HOSE REDUCER - 1" FHT X 3/4" MHT |
| 2 | IRRA-BA107MF | HOSE REDUCER - 1" MHT X 3/4" FHT |
| 3 | IRRHPF8C | 3/4" MHT X 3/4" MPT (OR 1/2" FPT) |
| 4 | IRRSM1 | 1" HOSE MENDER |
| 4 | IRRSM34 | 3/4" HOSE MENDER |
| 5 | IRRHYZ-SO | ZINC HOSE WYE WITH SHUT-OFFS |
| 6 | IRR075C | 3/4" BRASS HOSE COUPLING SET |
| 6 | IRR100C | 1" BRASS HOSE COUPLING SET |
| 7 | IRRHPF7 | 3/4" HOSE SWIVEL - 3/4" FHT X 3/4" FHT |
| 8 | IRRHN075W-10 | HOSE WASHER, 3/4", PACK OF 10 |
| 8 | IRRHN100W-10 | HOSE WASHER, 1", PACK OF 10 |
| 9 | IRRHPF13 | 1/2" FPT X 3/4" FHT |
| 10 | IRRHPF12 | 3/4" FPT X 3/4" FHT |
| 11 | IRRA-QC075 | 3/4" QUICK CONNECT FOR 5/8" AND 3/4" HOSE CONNECTIONS (SET) |
| 12 | IRRA-BA10NXSH | 1" FPT X 1" MALE PIPE TO HOSE THREAD ADAPTER |
| 13 | IRRA-BN107MM | 1" MPT X 3/4" MALE GHT PIPE TO HOSE THREAD ADAPTER |





ULTRAMAX TURBOSHIFT

Shifts from Light Fog to Full Stream



- The innovative TURBO SHIFT feature provides two distinct GPM ranges for added versatility. It's like having two nozzles in one.
- Start with the wider pattern for cooling and light watering at a low gallon - and then kick it into turbo for full flow when you dial it into a jet pattern.
- Both Full Throttle and Turbo Shift models All models offer multi-pattern spray: fog, jet stream, fan
- 1" and 3/4" Hose Inlet threads

- IRRNG550-DFH-75** 3/4" HIGH GPM (12-43 GPM)
- IRRNG550-DFH-10** 1" HIGH GPM (12-43 GPM)
- IRRNG550DFSH-10** 1" SUPER HIGH FLOW (34-104 GPM)



ULTRAMAX FULL THROTTLE

Maximum Flow Patterns



- Delivers a steady, high flow fog, jet stream and fan patterns
- Virtually indestructible and leak proof
- 1" and 3/4" Hose Inlet threads

- IRRNG500-SFH-75** 3/4" HIGH GPM (15-40 GPM)
- IRRNG500-SFH-10** 1" HIGH GPM (15-40 GPM)



MAGNUM ULTRAMAX ECONOMY PLUS SERIES

Turboshift Model



- IRRNG650-DFH-75** 3/4" HIGH GPM (12-43 GPM)
- IRRNG650-DFH-10** 1" HIGH GPM (12-43 GPM)



MAGNUM ULTRAMAX ECONOMY PLUS

Full Throttle Model



- IRRNG600-SFH-75** 3/4" HIGH GPM (15-40 GPM)
- IRRNG600-SFH-10** 1" HIGH GPM (15-40 GPM)

The same patterns, gallons and performance of the premium nozzles, but at a much lower cost because they are made of composite material instead of alloy.

Pricing is subject to change.



PRECISION NOZZLE KITS
Task Specific Nozzles



When you need a specific amount of water, for a specific task, the precision nozzles are your choice. Give the right nozzle to your employee to ensure they put the right amount of water down for their task. Choose a nozzle kit with brass shutoff or the nozzle only.

- Rainbow (Yellow) - soft cone water pattern great for lightly watering Greens, seed beds, transplants or delicate landscapes (15 gpm)
- Rainmaker (Green) - cone pattern for spot watering Greens without over saturating and creating runoff (23 gpm)
- Cloudburst (blue) - cone pattern that's great for localized dry spots & is our nozzle of choice for pellet pro applicators (35 gpm)
- Cyclone (red) - when you just need a lot of water in a flat fan controlled pattern on fairways, roughs or infield skin (50 GPM)

- IRRHN1500CV** RAINBOW
- IRRHN2300CV** RAINMAKER
- IRRHN4800CV** CLOUDBURST
- IRRHN5000CV** CYCLONE

INCLUDES NOZZLE, BRASS SHUT OFF & 1" ADAPTER

PRECISION NOZZLES ONLY
3/4" Size- Add Adapter For 1"



- IRRHN1500** RAINBOW (15 GPM)
- IRRHN2300** RAINMAKER (23 GPM)
- IRRHN4800** CLOUDBURST (35 GPM)
- IRRHN5000** CYCLONE (50 GPM)

COOL PRO

Cool Turf Without Over-Watering



We've all been there, spending our summer afternoons in the brutal heat keeping Greens cool. We can't chage that, but we can give you a tool that will make the job easier. The cool pro was designed for the simple task to cool, but not over water.

- 25 foot pattern delivers long reach for quicker syringing
- At 70 psi, creates 25 foot fog while only using 4-6 gpm
- Durable metal design
- Choose the nozzle only or purchase with a convenient hand held shutoff

- IRRHN0600** NOZZLE ONLY
- IRRHNC075** NOZZLE & SHUTOFF
- IRRCV075L** SHUTOFF ONLY

CAN'T DECIDE & WANT THEM ALL?

Nozzle Locker

Just need to have all the fire power right at your fingertips? Here's our souldtion, all of the best nozzles, in a secure, unbreakable case.



- Entire precision nozzle series
- Brass high flow valve
- Cool pro nozzle
- Ultramax turbo shift nozzle

- IRRHP-K3** 3/4"
- IRRHP-K5** 1"



MAGNUM™ ULTRAMAX MULTI-BLAST™ HOSE NOZZLE

4-IN-1 Pressure Nozzle



Fully Adjustable 4 in 1 feature:
• Clickable flow rate adjustment from off to flush with four flow rates in between



IRRNG850 1"

MAGNUM-MINI™ GOLD SERIES ADJUSTABLE SPRAY NOZZLE

Ideal Nozzle for Low – Medium Pressure Applications



IRRNG350 3/4"

PROLINE GOLD SERIES SPRAY NOZZLES

Pattern Master & Variable Spray

Pattern Master



Variable Spray



- IRRNG250-8S PATTERN MASTER THUMB CONTROL
- IRRNG250-8S PATTERN MASTER TRIGGER FLOW
- IRRNG250-P VARIABLE SPRAY THUMB CONTROL
- IRRNG200-P VARIABLE SPRAY TRIGGER FLOW



RAINPRO NOZZLES

- IRRRP-75PL 1 RAINPRO GENTLE SPRAY NOZZLE - 3/4"
- IRRRPW-75PL 2 RAINPRO GENTLE SPRAY WAND 30" - 3/4"
- IRRRSHN-75 3 RAINPRO SHOWER NOZZLE 3/4" OR 1" INLET
Comes with 3/4" adapter

TWIST-EASE KINK ELIMINATOR
Irrigation Hose Swivel



- IRRRSF-75 3/4" KINK ELIMINATOR
- IRRRSF-100 1" KINK ELIMINATOR

MAGNUM STINGER NOZZLE
All Pressure Nozzle



IRRNG400 3/4"

BUCKNER GREENS SPRAY NOZZLE
Bronze - 1 Inch Inlet



IRRNZ022 1" HOSE THREAD

MAGNUM
3/4" Inlet Solid Metal



IRRNG450 3/4"

POWER BLAST SWEEPER NOZZLES

3/4" adjustable stream



IRRGNA-75

3/4" x 2"



IRRSN2-75

3/4" x 6"



IRRSN6-75

1" x 8"



IRRSN8-10

TRIGGER NOZZLE
3/4" Inlet



IRR60-12721

TOURNAMENT-READY PLUS PELLETS

With Actosol & Micro-Nutrients



16 PELLETS PER CASE
IRRUHTRPLPEL-16

TOURNAMENT-READY PELLETS



16 PELLETS PER CASE
IRRUHTRPEL-16

H2O MAXIMIZER® PELLETS



16 PELLETS PER CASE
IRRUHH2OPEL-16

TOURNAMENT READY WET-WELL PELLETS



- Uniform moisture management (doesn't bind in the thatch layer)
- Increases soil moisture without causing "spongy turf" problems
- Easily applied through pump station wet well to apply to the entire course during normal watering
- 2 pellet pack - 8lbs each

2 PELLETS PER CASE
IRRUHTRPEL-8

PELLET PRO APPLICATORS



IRRA-PPWA50K
PELLET PRO APPLICATOR W/ SHUT OFF & CLOUDBURST NOZZLE

IRRA-PPWASHNK
PELLET PRO APPLICATOR W/ SHUT OFF & RAINPRO NOZZLE

IRRA-PPBK
PELLET PRO REPLACEMENT BOWL & GASKET

PELLET PRO QUICK COUPLER MOUNT



IRRA-PPQ-075 3/4" FHT INLET IN-LINE APPLICATOR

IRRA-PPQ-100 1" FHT INLET IN-LINE APPLICATOR

IRRA-PPBG BOWL BUNA GASKET

IRRA-PPBK BOWL W/ GASKET

IRRA-PPB BOWL ONLY (NO GASKET)

IRRA-BA107FM HOSE ADAPTER, 1" FHT TO 3/4" MHT

LIQUIDPRO WETTING AGENT APPLICATOR GUN

IRRA-LPWWASHNK





PAR WEST PREMIUM MICRO SPRINKLER STARTER KIT

IRMSKIT



- 100' of PVC tubing
- 10 bases with fittings and nozzles
- all fittings needed for 3 sets

All components are also sold separately below.

Our Micro Sprinkler Systems allow you to cost effectively soak a nagging hot spot without affecting golfers or causing run off.

INDIVIDUAL COMPONENTS

- IRRMSH50-100** TUBING (100 FT. ROLL)
- IRRMSH50-200** TUBING (200 FT. ROLL)
- IRMS444** BASE ALONE
- IRMS20575** REPLACEMENT NOZZLE
- IRR050-0400-80** NOZZLE RISER - 4"
- IRR430-005** NOZZLES COUPLER
- IRMSF64** FEMALE TUBE ADAPTER
- IRMSAP110** SWIVEL ADAPTER



IRRMSH50-100
IRRMSH50-200



IRMS20575



IRR0500-400-80



IRMS444



IRMSF64



IRMSAP100



IRMSAP110



IRR430-005-45



PRESSURE REGULATOR FOR MICRO SPRINKLER KITS
Control Application Rates & Prevent Blowouts

THIS PRESSURE REGULATOR IS THE PERFECT ADDITION TO OUR MICRO SPRINKLER KIT

- Keeps pressure consistent at 25 PSI
- 3/4 inch female hose thread x 3/4 inch male hose thread
- More accurate flow rates for flushing Greens
- Prevent blow outs by controlling pressure



IRR51388

Pricing is subject to change.



SPOTSHOT

Low Volume Portable Sprinkler



20 FT. RADIUS / 0.65 GPM (0.16 IN./HR.) 20 FT. RADIUS / 1.2 GPM (0.26 IN./HR.)

SpotShot™ is an expandable sprinkler system kit ideal for turf areas requiring low volume watering for extended periods. Connect the Starter Kit to a quick coupler (or golf sprinkler with the HoseTap and connect Add-On Kits for larger area needs.

- **Starter Kit includes** 20' of 1/2" flexible PVC tubing with connection fittings, pressure regulator, sprinkler base and low volume rotating sprinkler (20 ft. radius / 0.65 GPM - 0.16 in./hr.)At 70 psi, creates 25 foot fog while only using 4-6 gpm
- **Add-On Kit includes** 20' of 1/2" flexible PVC tubing with connection fittings, sprinkler base and low volume rotating sprinkler (20 ft. radius / 0.65 GPM - 0.16 in./hr.) Choose the nozzle only or purchase with a convenient hand held shutoff
- **Micro-Sprinkler Options:**
- RED - 20 ft. radius / 0.65 GPM (0.16 in./hr.)
- BLUE - 20 ft. radius / 1.2 GPM - (0.26 in./hr.)

- IRRSS-SK** STARTER KIT - 20 FT. RADIUS / 0.65 GPM
- IRRSS-AOK** ADD-ON KIT - 20 FT. RADIUS / 0.65 GPM
- IRRSS-SK-26** STARTER KIT - 20 FT. RADIUS / 1.2 GPM
- IRRSS-AOK-26** ADD-ON KIT - 20 FT. RADIUS / 1.2 GPM
- IRRSS-S16** SPRINKLER 20 FT. RADIUS / 0.65 GPM
- IRRSS-S26** SPRINKLER 20 FT. RADIUS / 1.2 GPM
- IRRSS-SB** SPRINKLER BASE

ECONOMY PORTABLE SPRINKLER BASE

W/ 3/4" Hose Swivel Connection



- IRRSBASS** COMPLETE W/ SPRINKLER ASSEMBLY
- IRRSB75** BASE ONLY - 3/4"
- IRRA-BA107MF** ADAPTER - 1" FHT X 3/4" MHT

SPRINKLER ASSEMBLY INCLUDES 4" ADJUSTABLE HEAD & NIPPLE

ROLLER PRO

Portable Sprinkler Base

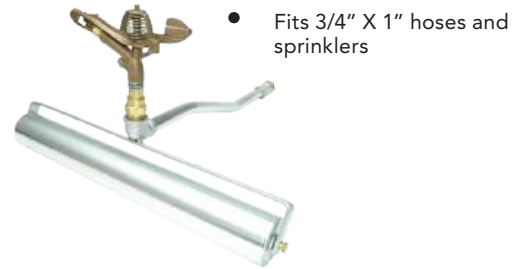

- Fits 3/4" X 1" hoses and sprinklers
- IRRA-RP221** ROLLER BASE ONLY
- IRRA-RPASS** BASE WITH SPRINKLER

IMPACT SPRINKLER IS A 3/4" FULL CIRCLE HEAD

IMPACT SPRINKLERS

Full Or Part Circle



- IRRS1075F** 3/4" FULL CIRCLE
- IRRS1075P** 3/4" PART CIRCLE
- IRRS1100F** 1" FULL CIRCLE
- IRRS1100P** 1" PART CIRCLE
- IRRS1125F** 1.25" FULL CIRCLE
- IRRS1125P** 1.25" PART CIRCLE

HUNTER PGP ROTOR

Adjustable Arc



- The industry standard, Best Selling Rotor Since 1981
- Arc setting: 40 to 360 degrees
- Through-the-top arc adjustment
- Quick check arc mechanism
- Water lubricated gear-drive
- Nozzle racks: red, blue, gray low angle

- IRRHGP-04** 4" STANDARD
- IRRHGP-00** 4" SHRUB ROTOR
- IRRHGP-04-CV** 4" W/ CHECK VALVE
- IRRHGP-00-CV** 4" SHRUB W/ CHECK VALVE

Case Discounts Available

ECONOMY BRASS ELECTRIC VALVE

Globe Style

**BEST
\$
VALUE**



IRRAGV-125 1.25"

IRRAGV-150 1.5"

RAINBIRD BRASS ELECTRIC VALVE

Globe Style



IRRRB100EFBCP 1" CALL FOR PRICING

IRRRB150EFBCP 1.5" CALL FOR PRICING

IRRRB200EFBCP 2" CALL FOR PRICING

RAINBIRD PLASTIC VALVE

Globe Style



IRRRB100PEB 1" CALL FOR PRICING

IRRRB150PEB 1.5" CALL FOR PRICING

IRRRB200PEB 2" CALL FOR PRICING

HUNTER I-20 SERIES ROTOR

Plastic Body And Riser



- 4 inch, 6 inch or 12 inch models
- Plastic or stainless steel risers
- Radius of 17-46 feet
- Arc settings from 50 - 360 degrees
- 34 Nozzle choices
- 5 year warranty

CALL FOR PRICING

IRRHI20-04 4" PLASTIC

IRRHI20-04-SS 4" STAINLESS

IRRHI20-06 6" PLASTIC

IRRHI20-06-SS 6" STAINLESS

IRRHI20-12 12" PLASTIC

HUNTER I-25 SERIES ROTOR

Plastic Body And Riser



- 4 inch or 6 inch models
- Plastic or stainless steel risers
- Radius of 40-71 feet
- Arc settings from 50 - 360 degrees
- 12 Nozzle choices
- 5 year warranty

CALL FOR PRICING

IRRHI25-04 4" PLASTIC

IRRHI25-06 6" PLASTIC

Case Discounts Available.

HUNTER I-40 SERIES ROTOR

Stainless Steel Riser



- Models stainless riser: 4", 6"
- Arc setting: 50 to 360 degrees
- Factory installed rubber cover
- Nozzle choices: 12
- Nozzle ranges I-40: #8 to #25
- Nozzle ranges I-40-ON: #15 to #28
- Through-the-top arc adjustment
- Quick check arc mechanism
- Water lubricated gear-drive
- Warranty period: 5 years

CALL FOR PRICING

IRRHI40-04-SS 4" STAINLESS

IRRHI40-06-SS 6" STAINLESS



RAINBIRD 1800 SAM POP-UP BODY

Pressure Regulator & Check Valve

- 1800 Series pop-up spray head with Seal-A-Matic™ check valve
- Designed for use with all Rain Bird plastic spray head nozzles
- Traps water in lateral pipes in elevation changes of up to 14 feet
- Prevents drainage from spray heads at lower elevations
- Stops water waste
- Ends landscape damage due to flooding and/or erosion

CALL FOR PRICING

6" IRRRB1806SAM

12" IRRRB1812SAM

RAINBIRD 1800 POP-UP BODY

Nozzle Not Included



- Co-molded wiper seal provides unmatched resistance to grit, pressure and the environment
- Precision controlled flush at pop-down clears debris from unit, assuring positive stem retraction in all soil types
- Two-piece ratchet mechanism allows easy nozzle pattern alignment and provides added durability
- Five-year trade warranty

CALL FOR PRICING

6" IRRRB1806

12" IRRRB1812

RAINBIRD 1800 SERIES NOZZLES
Matched Precipitation Rate Nozzles

CALL FOR PRICING

| | | |
|-------------|---------|-----------------------------|
| IRRR-5Q | 5 feet | QUARTER - 90 DEGREE |
| IRRRB-5H | 5 feet | HALF - 180 DEGREE |
| IRRRB-5F | 5 feet | FULL - 360 DEGREE |
| IRRRB-8Q | 8 feet | QUARTER - 90 DEGREE |
| IRRRB-8H | 8 feet | HALF - 180 DEGREE |
| IRRRB-8F | 8 feet | FULL - 360 DEGREE |
| IRRRB-10Q | 10 feet | QUARTER - 90 DEGREE |
| IRRRB-10H | 10 feet | HALF - 180 DEGREE |
| IRRRB-10F | 10 feet | FULL - 360 DEGREE |
| IRRRB-12Q | 12 feet | QUARTER - 90 DEGREE |
| IRRRB-12H | 12 feet | HALF - 180 DEGREE |
| IRRRB-12TQ | 12 feet | THREE QUARTERS - 270 DEGREE |
| IRRRB-12F | 12 feet | FULL - 360 DEGREE |
| IRRRB-15Q | 15 feet | QUARTER - 90 DEGREE |
| IRRRB-15H | 15 feet | HALF - 180 DEGREE |
| IRRRB-15TQ | 15 feet | THREE QUARTERS - 270 DEGREE |
| IRRRB-15F | 15 feet | FULL - 360 DEGREE |
| IRRRB-15EST | 15 feet | END STRIP |
| IRRRB-15CST | 15 feet | CENTER STRIP |
| IRRRB-15RCS | 15 feet | RIGHT CORNER STRIP |
| IRRRB-15LCS | 15 feet | LEFT CORNER STRIP |
| IRRRB-15SST | 15 feet | SIDE STRIP |

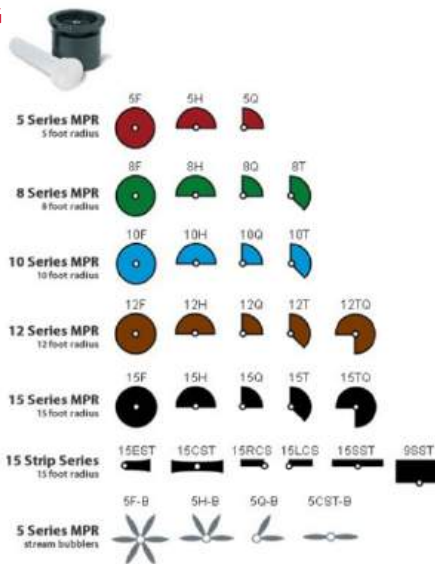

R-820/R-821 SERIES



REPLACES

Rain Bird "D" Series Eagle 700 Series Plastic Body SAM Impacts Metal Body SAM Impacts R-70 Series Buckner Rotors 1360 Hunter I-40 TORO® 640-2001 Series Thompson 176-187 Nelson 6500-7000 7500 Series

- Radius 53' - 72'
- Flow Rate: 11 - 31.3 GPM
- 4 pop-up (self-lushing) Stainless Steel riser
- All-in-one full & part circle
- ACME threads

R-850/R-851 SERIES

- Radius 53' - 72'
- Flow Rate: 11 - 31.3 GPM
- 4 pop-up (self-lushing) Stainless Steel riser
- All-in-one full & part circle
- ACME threads

REPLACES

Rain Bird "D" Series Eagle 700 Series TORO® 630-660 Series 730-760 Series

| SERIES | PART # | INLET | TYPE |
|--------------------------|------------|-------|----------------------------------|
| R-850 PART & FULL CIRCLE | IRRR-850-H | 1" | HYDRAULIC |
| | IRRR-850-C | 1" | CHECK-O-MATIC |
| | IRRR-850-E | 1" | ELECTRIC |
| R-851 FULL CIRCLE | IRRR-851-H | 1" | HYDRAULIC |
| | IRRR-851-C | 1" | CHECK-O-MATIC |
| | IRRR-851-E | 1" | ELECTRIC |
| R-820 | IRRR-820-B | 1" | PART & FULL CIRCLE CHECK-O-MATIC |
| R-821 | IRRR-820-B | 1" | FULL CIRCLE CHECK-O-MATIC |



150 IRRIGATION & WATERING



IRRINS-B-871 - FULL CIRCLE

- Radius 66' - 100'
- Flow Rate: 25.1 - 66.0 GPM
- 3" pop-up Stainless Steel riser

PERFORMANCE CHART

| Bear Nozzle | Base Pressure (PSI) | | | | | | | | | | TORO® Nozzle | | |
|---------------|---------------------|------|------|------|------|------|------|------|------|------|--------------|-----|-----|
| | 50 | 55 | 60 | 65 | 70 | 75 | 80 | 85 | 90 | 95 | 100 | 50 | 70 |
| 02 Yellow GPM | 15.1 | 16.1 | 17.1 | 18.1 | 19.1 | 20.1 | 21.1 | 22.1 | 23.1 | 24.1 | 25.1 | 50 | 70 |
| 04 Green GPM | 25.1 | 26.1 | 27.1 | 28.1 | 29.1 | 30.1 | 31.1 | 32.1 | 33.1 | 34.1 | 35.1 | 80 | 100 |
| 08 Brown GPM | 45.1 | 46.1 | 47.1 | 48.1 | 49.1 | 50.1 | 51.1 | 52.1 | 53.1 | 54.1 | 55.1 | 150 | 200 |
| 12 Blue GPM | 65.1 | 66.1 | 67.1 | 68.1 | 69.1 | 70.1 | 71.1 | 72.1 | 73.1 | 74.1 | 75.1 | 220 | 300 |



| INLET | SERIES | TYPE |
|-------|--------|-------------|
| 1.5" | 871 | FULL CIRCLE |

IRRINS-B-871

TORO SPRINKLER PARTS

Bear Irrigation

CALL FOR PRICING



IRRINS-T-690-FC - FULL CIRCLE

- Radius 91' - 100'
- Flow Rate: 57.1 - 66.0 GPM
- 3" pop-up Stainless Steel riser

NOZZLE GUIDE

| BEAR Nozzle | TORO® 690 Series |
|-------------|------------------|
| Black | 90 |
| Blue | 91 |



| INLET | SERIES | TYPE |
|-------|--------|-------------|
| 1.5" | 871 | FULL CIRCLE |

IRRINS-B-871

Bear Irrigation offers the versatile solution: Conversion Kits designed to upgrade existing TORO® or RainBird® sprinklers while still providing Bear's superior performance.



IRRINS-T-680 SERIES

- Radius 56' - 82'
- Flow Rate: 13.0 - 35.3 GPM
- 3" pop-up Stainless Steel riser

PERFORMANCE CHART

| Bear Nozzle | Base Pressure (PSI) | | | | | | | | | | TORO® Nozzle | | |
|---------------|---------------------|------|------|------|------|------|------|------|------|------|--------------|-----|-----|
| | 50 | 55 | 60 | 65 | 70 | 75 | 80 | 85 | 90 | 95 | 100 | 50 | 70 |
| 02 Yellow GPM | 11.0 | 11.8 | 12.6 | 13.4 | 14.2 | 15.0 | 15.8 | 16.6 | 17.4 | 18.2 | 19.0 | 50 | 70 |
| 04 Green GPM | 18.0 | 19.0 | 20.0 | 21.0 | 22.0 | 23.0 | 24.0 | 25.0 | 26.0 | 27.0 | 28.0 | 80 | 100 |
| 08 Brown GPM | 35.0 | 36.0 | 37.0 | 38.0 | 39.0 | 40.0 | 41.0 | 42.0 | 43.0 | 44.0 | 45.0 | 150 | 200 |
| 12 Blue GPM | 52.0 | 53.0 | 54.0 | 55.0 | 56.0 | 57.0 | 58.0 | 59.0 | 60.0 | 61.0 | 62.0 | 220 | 300 |

Shaded areas represent pressure not recommended for optimal nozzle performance.



| INLET | SERIES | TYPE |
|-------|--------|-------------|
| 1.5" | 680 | FULL CIRCLE |
| 1.5" | 680 | PART CIRCLE |

IRRINS-T-680-FC

IRRINS-T-680-PC

IRRINS-T-730 SERIES

IRRINS-T-830 SERIES

IRRINS-T-730 SERIES

- Radius 52' - 75'
- Flow Rate: 11.0 - 35.3 GPM
- 3" pop-up riser



FULL



PART



| INLET | SERIES | TYPE |
|-------|--------|-------------|
| 1" | 730 | FULL CIRCLE |
| 1" | 735 | PART CIRCLE |
| 1" | 830 | FULL CIRCLE |
| 1" | 835 | PART CIRCLE |
| 1" | INF34 | PART CIRCLE |

IRRINS-T-730-FC

IRRINS-T-735-PC

IRRINS-T-830-FC

IRRINS-T-835-PC

IRRINS-T-INF34-PC

PERFORMANCE CHART

| Bear Nozzle | Base Pressure (PSI) | | | | | | | | | | TORO® Nozzle | | |
|---------------|---------------------|------|------|------|------|------|------|------|------|------|--------------|-----|-----|
| | 50 | 55 | 60 | 65 | 70 | 75 | 80 | 85 | 90 | 95 | 100 | 50 | 70 |
| 02 Yellow GPM | 11.0 | 11.8 | 12.6 | 13.4 | 14.2 | 15.0 | 15.8 | 16.6 | 17.4 | 18.2 | 19.0 | 50 | 70 |
| 04 Green GPM | 18.0 | 19.0 | 20.0 | 21.0 | 22.0 | 23.0 | 24.0 | 25.0 | 26.0 | 27.0 | 28.0 | 80 | 100 |
| 08 Brown GPM | 35.0 | 36.0 | 37.0 | 38.0 | 39.0 | 40.0 | 41.0 | 42.0 | 43.0 | 44.0 | 45.0 | 150 | 200 |
| 12 Blue GPM | 52.0 | 53.0 | 54.0 | 55.0 | 56.0 | 57.0 | 58.0 | 59.0 | 60.0 | 61.0 | 62.0 | 220 | 300 |

Shaded areas represent pressure not recommended for optimal nozzle performance.

RAINBIRD SPRINKLER PARTS

Bear Irrigation

CALL FOR PRICING

IRRINS-R-700 - FULL CIRCLE IRRINS-R-750 - PART CIRCLE

- Radius 56' - 72'
- Flow Rate: 13.1 - 31.3 GPM
- 4 pop-up (self-lushing) Stainless Steel riser

PERFORMANCE CHART

| Bear Nozzle | Base Pressure (PSI) | | | | | | | | | | Rain Bird® Nozzle | | |
|---------------|---------------------|------|------|------|------|------|------|------|------|------|-------------------|-----|-----|
| | 50 | 55 | 60 | 65 | 70 | 75 | 80 | 85 | 90 | 95 | 100 | 50 | 70 |
| 02 Orange GPM | 13.1 | 14.1 | 15.1 | 16.1 | 17.1 | 18.1 | 19.1 | 20.1 | 21.1 | 22.1 | 23.1 | 50 | 70 |
| 04 Blue GPM | 21.1 | 22.1 | 23.1 | 24.1 | 25.1 | 26.1 | 27.1 | 28.1 | 29.1 | 30.1 | 31.1 | 80 | 100 |
| 08 Green GPM | 42.1 | 43.1 | 44.1 | 45.1 | 46.1 | 47.1 | 48.1 | 49.1 | 50.1 | 51.1 | 52.1 | 150 | 200 |
| 12 Red GPM | 63.1 | 64.1 | 65.1 | 66.1 | 67.1 | 68.1 | 69.1 | 70.1 | 71.1 | 72.1 | 73.1 | 220 | 300 |

| INLET | SERIES | TYPE |
|-------|--------|-------------|
| 1.25" | 730 | FULL CIRCLE |
| 1.25" | 735 | PART CIRCLE |

IRRINS-R-700

IRRINS-R-750



FULL & PART

FULL

IRRINS-R-47DR

IRRINS-R-51DR

IRRINS-R-470R - PART & FULL CIRCLE IRRINS-R-51DR - FULL CIRCLE

- Radius 53' - 72'
- Flow Rate: 12.5 - 33.0 GPM
- 3" pop-up stainless steel riser

PERFORMANCE CHART

| Bear Nozzle | Base Pressure (PSI) | | | | | | | | | | Rain Bird® Nozzle | | |
|---------------|---------------------|------|------|------|------|------|------|------|------|------|-------------------|-----|-----|
| | 50 | 55 | 60 | 65 | 70 | 75 | 80 | 85 | 90 | 95 | 100 | 50 | 70 |
| 02 Orange GPM | 12.5 | 13.5 | 14.5 | 15.5 | 16.5 | 17.5 | 18.5 | 19.5 | 20.5 | 21.5 | 22.5 | 50 | 70 |
| 04 Blue GPM | 20.5 | 21.5 | 22.5 | 23.5 | 24.5 | 25.5 | 26.5 | 27.5 | 28.5 | 29.5 | 30.5 | 80 | 100 |
| 08 Green GPM | 41.5 | 42.5 | 43.5 | 44.5 | 45.5 | 46.5 | 47.5 | 48.5 | 49.5 | 50.5 | 51.5 | 150 | 200 |
| 12 Red GPM | 62.5 | 63.5 | 64.5 | 65.5 | 66.5 | 67.5 | 68.5 | 69.5 | 70.5 | 71.5 | 72.5 | 220 | 300 |

Shaded areas represent pressure not recommended for optimal nozzle performance.

BEAR nozzles (G, H, W) can be used on 470 to increase distance.



SUPER VALUE

Fit Toro Or Rainbird Golf Sprinklers

- IRRRP-1006 1" INLET ELECTRIC - TORO, BEAR, JOHN DEERE, SIGNATURE
- IRRRP-1016 1" INLET HYDRAULIC - TORO, BEAR, JOHN DEERE, SIGNATURE
- IRRRP-1047E 1.5" INLET TORO ELECTRIC
- IRRRP-1047HC 1.5" INLET TORO HYDRAULIC AND CHECK-0-MATIC
- IRRRP-1068E 1.5" INLET ELECTRIC - BEAR, JOHN DEERE, SIGNATURE
- IRRRP-1068HC 1.5" INLET ELECTRIC - BEAR, JOHN DEERE, SIGNATURE



1" INLET



1.5" INLET



1.5" INLET

CALL FOR PRICING

Pricing is subject to change.

PROFILE SOLID METAL IRRIGATION NOZZLES

730 SERIES FULL CIRCLE FRONT & REAR NOZZLES

| PART # | NOZZLE COLOR RANGE / SPREADER | TORO NOZZLE # |
|---------------|-------------------------------|---------------|
| IRRT730-3313 | BROWN 33 / GRAY 13 | 33 |
| IRRT730-3413 | BLUE 34 / GRAY 13 | 34 |
| IRRT730-3515 | VIOLET 35 / RED 15 | --- |
| IRRT730-3515L | GREEN 35 / RED 15* | 35 |
| IRRT730-3615 | RED 36 / RED 15* | 36 |



760 AND 860 SERIES PART CIRCLE REAR NOZZLES

| PART # | NOZZLE COLOR MIDRANGE / CLOSE-IN |
|------------|----------------------------------|
| IRRT760-GY | 760 - GRAY / YELLOW |
| IRRT860-GY | 860 - GRAY / YELLOW |



835 SERIES FULL CIRCLE REAR NOZZLES

| PART # | NOZZLE COLOR MIDRANGE / CLOSE-IN |
|-------------|----------------------------------|
| IRRT8355-WP | WHITE / PLUG |



834, DT SERIES FULL CIRCLE REAR NOZZLES

| PART # | NOZZLE COLOR MIDRANGE / CLOSE-IN |
|------------|----------------------------------|
| IRRT834-GY | 834 - GRAY / YELLOW |
| IRRT100-GY | DT34 - GRAY / YELLOW |



670 SERIES FULL CIRCLE REAR NOZZLES

| PART # | NOZZLE COLOR MIDRANGE / CLOSE-IN |
|------------|----------------------------------|
| IRRT670-BY | BLACK / YELLOW |



780, 854S, DT SERIES FULL/PART CIRCLE REAR NOZZLES

| PART # | NOZZLE COLOR MIDRANGE / CLOSE-IN |
|------------|----------------------------------|
| IRRT780-BY | 780 - BLACK / YELLOW |
| IRRT854-BY | 854S - BLACK / YELLOW |
| IRRT150-BY | DT54/55 - BLACK / YELLOW |



690 SERIES FULL CIRCLE REAR NOZZLES

| PART # | NOZZLE COLOR SPREADER |
|-----------|-----------------------|
| IRRT690-G | GRAY |



855S SERIES FULL CIRCLE REAR NOZZLES

| PART # | NOZZLE COLOR SPREADER |
|-------------|-----------------------|
| IRRT855S-PP | PINK / PLUG |



750 SERIES FULL CIRCLE FRONT & REAR NOZZLES

| PART # | NOZZLE COLOR RANGE / SPREADER |
|--------------|-------------------------------|
| IRRT750-5617 | RED 56 / LAVENDER 17 |
| IRRT750-5717 | GRAY 57 / LAVENDER 17 |



EAGLE 700 SERIES FULL CIRCLE NOZZLES

| PART # | NOZZLE COLOR MIDRANGE / CLOSE-IN |
|--------------|----------------------------------|
| IRRR70028-RG | 28 - BLUE / GRAY |
| IRRR70032-RG | 32 - RED / GRAY |



RAINBIRD HEADS

51 SERIES FULL CIRCLE FRONT & REAR NOZZLES

| PART # | NOZZLE COLOR RANGE / SPREADER | RAINBIRD NOZZLE # |
|---------------|-------------------------------|-------------------|
| IRRR51-1411.5 | WHITE 14 / GRAY 11.5 | 14 / 11.5 |
| IRRR51-1611.5 | BLUE 16 / GRAY 11.5 | 16 / 11.5 |
| IRRR51-1811.5 | YELLOW 18 / GRAY 11.5 | 18 / 11.5 |
| IRRR51-2011.5 | RED 20 / GRAY 11.5 | 20 / 11.5 |
| IRRR51-2213 | GREEN 22 / BLACK 13 | 22 / 13 |
| IRRR51-2413 | BLACK 24 / BLACK 13 | 24 / 13 |



900 SERIES FULL CIRCLE REAR NOZZLE

| PART # | NOZZLE COLOR CLOSE-IN |
|-----------|-----------------------|
| IRRR900-M | MAROON |



CARSON RECTANGULAR VALVE BOX

14" X 19" Green With Lid



IRR1419-12-4B CARSON 14" X 19" VALVE BOX W/ LID
IRRC1419-4 GREEN LID ONLY

NDS RECTANGULAR VALVE BOX

14" X 19" Green With Lid



IRRNDS14X19 NDS 14" X 19" VALVE BOX W/ LID
IRRNDS317C GREEN LID ONLY

All Other Sizes Available

CARSON TRUSTEE VALVE BOX

6" With Green Lid



IRRC708-9-4 6" ROUND VALVE BOX W/ GREEN LID
IRRC910-10-4B 10" ROUND VALVE BOX W/ GREEN LID

NDS ROUND VALVE BOX

With Green Lid



IRRNDS6R 6" ROUND VALVE BOX W/ GREEN LID
IRRNDS10R 10" ROUND VALVE BOX W GREEN LID

VERSALID

Fits Any 6"-7" Round Valve Box



IRRVL-6 6-INCH GREEN LID
IRRVL-10 10-INCH GREEN LID
IRRVL-6P 6-INCH PURPLE LID
IRRVL-10P 10-INCH PURPLE LID
IRRVL-6T 6-INCH TAN LID
IRRVL-10T 10-INCH TAN LID



NIBCO BRONZE GATE VALVES

- Threaded w/ cross handle, 200 psi working pressure

IRRNT113-1 1"
IRRNT113-1.25 1 1/4"
IRRNT113-1.5 1 1/2"
IRRNT113-2 2"
IRRNT113-2.5 2 1/2"



BRASS GATE VALVES

- Threaded w/ cross handle, 200 psi working pressure

IRRBGV-050X 1/2"
IRRBGV-075X 3/4"
IRRBGV-100X 1"
IRRBGV-125X 1 1/4"
IRRBGV-150X 1 1/2"
IRRBGV-200X 2"
IRRBGV-250X 2 1/2"
IRRBGV-300X 3"
IRRBGV-400X 4"

WESTLAKE JOINT CONFIGURATOR

Create Your Part Number

| | | | | | | |
|---|------|------|------|------|------|------|
| G | STEP | STEP | STEP | STEP | STEP | STEP |
| | 1 | 2 | 3 | - | 4 | 4 |
| | | | | | 4 | 4 |

HOW TO ORDER YOUR SWING JOINT

Step 1 - Choose Body Diameter by Number Below

- 1 1"
- 2 1.25"
- 3 1.5"

step 2 - Specify an Inlet by Number Below

- 1 Socket
- 2 Spigot (short)
- 3 Male Thread (Mipt)
- 4 Male Acme
- 5 Metric Spigot
- 6 Male Bspt
- 7 Long Spigot (4" Long)
- 8 Female Bspt
- 9 Reducing Female Bspt
- h Spigot Saddle Connection (increases from 1" spigot to swing joint size)
- m Main Line (reduces from 1.5" acme to swing joint size)
- p Tap't Saddle Connection (reduces from 1.5" acme to swing joint size)



step 3 - Specify an Outlet by Number

- 1 Socket
- 2 mipt (available in 1", 1.25" & 1.5")
- 3 Enlarging Mipt (available in 1", 1.25" & 1.5")
- 4 Mipt Special (available in 1" and 1.25")
- 5 Thread Bspt (available in 1", 1.25" & 1.5")
- 6 Enlarging Bspt (available in 1.5")
- 7 Reducing Mipt (available in 1")
- 8 Increasing Acme (available in 1.5")
- 9 Increasing Bspt (available in 1.25")
- 0 Acme (available in 1", 1.25" & 1.5")
- a Acme special (available in 1.25")
- c Reducing Acme (available in 1")

step 4 - Specify Lay Length

- 1__ kits - specify size
- 208 8" unitized standard size
- 212 12" unitized standard size
- 218 18" unitized standard size
- 310 10" fabricated size
- 324 24" fabricated size
- 330 30" fabricated size
- 408 8" unitized triple top size
- 412 12" unitized triple top size
- 418 18" unitized triple top size
- 510 10" fabricated triple top size
- 524 24" fabricated triple top size
- 530 30" fabricated triple top size

Par west offers the highest quality of Westlake Fittings!
 Sizes offered are 1/2", 3/4", 1", 1 1/4", 1 1/2", 2, and 4" in
 schedule 40 and 80 families.

Due to new tariff taxes, please call for a quote with current
 pricing as prices are subject to change.

WESTLAKE FEMALE ADAPTER
 SCH. 40



WESTLAKE MALE ADAPTER
 SCH. 40



WESTLAKE THREADED CAP
 SCH. 40



THREADED REDUCER BUSHING
 SCH. 40



WESTLAKE SLIP REDUCER BUSHING
 SCH. 40



WESTLAKE SLIP CAP
 SCH. 40



THREADED COUPLING
 SCH. 80



THREADED COUPLING
 SCH. 40



WESTLAKE SLIP X FEMALE NPT 90
 SCH. 40



WESTLAKE SLIP X FEMALE THREADED TEE
 SCH. 40



WESTLAKE FEMALE THREADED ELBOW
 SCH. 40



WESTLAKE FEMALE THREADED ELBOW
 SCH. 80



WESTLAKE 90 STREET ELL ADAPTER MARLEX



SLIP X SLIP X FPT REDUCING TEE
 SCH. 40



SLIP X SLIP X SLIP REDUCING TEE
 SCH. 40



WESTLAKE 90 STREET ELL ADAPTER
 SCH. 40



Par west offers the highest quality of Westlake Fittings!
 Sizes offered are 1/2", 3/4", 1", 1 1/4", 1 1/2", 2, and 4" in
 schedule 40 and 80 families.

Due to new tariff taxes, please call for a quote with current
 pricing as prices are subject to change.

PVC UNION CONNECTIONS
 SCH. 40 OR SCH. 80



SLIP FIX REPAIR COUPLING
 SCH. 40



COMPRESSION REPAIR COUPLING
LASCOTITE



WESTLAKE SLIP COUPLING
 SCH. 40



WESTLAKE SLIP ELBOW
 SCH. 40



WESTLAKE 45 DEGREE
SLIP ELBOW
 SCH. 40



WESTLAKE SLIP TEE
 SCH. 40



CHRISTY'S RED HOT GLUE



- QUART **IRRCRHG-Q**
- GALLON **IRRCRHG-G**
- DAUBER **IRRCQD**
- EMPTY QUART CONTAINER **IRRCEC-Q**

CHRISTY'S PURPLE PRIMER



- QUART **IRRCPP-Q**
- GALLON **IRRCPP-G**
- DAUBER **IRRCQD**

PREMIUM TEFLON TAPE
 Pro Strength



- 1/2" x 520" **SHPTT1/2**
- 3/4" x 520" **SHPTT3/4**
- 1" x 520" **SHPTT1**

PIPE WRAP TAPE
 UPC-Certified



2" x 100 x 10 mil **IRRPWT2X100**

ELECTRICAL TAPE
 Sold in 10 Rolls Packs



3/4" x 60 **SHPET**



SCHEDULE 80 NIPPLES
CALL FOR PRICING



| LENGTH | 1/2" PART # | 3/4" PART # | 1" PART # | 2" PART # |
|--------|----------------|----------------|----------------|----------------|
| CLOSE | IRR050-0100-80 | IRR075-0100-80 | IRR100-0100-80 | IRR200-0100-80 |
| 2" | IRR050-0200-80 | IRR075-0200-80 | IRR100-0200-80 | N/A |
| 3" | IRR050-0300-80 | IRR075-0300-80 | IRR100-0300-80 | IRR200-0300-80 |
| 4" | IRR050-0400-80 | IRR075-0400-80 | IRR100-0400-80 | IRR200-0400-80 |
| 5" | IRR050-0500-80 | IRR075-0500-80 | IRR100-0500-80 | IRR200-0500-80 |
| 6" | IRR050-0600-80 | IRR075-0600-80 | IRR100-0600-80 | IRR200-0600-80 |
| 8" | IRR050-0800-80 | IRR075-0800-80 | IRR100-0800-80 | IRR200-0800-80 |
| 10" | IRR050-1000-80 | IRR075-1000-80 | IRR100-1000-80 | IRR200-1000-80 |
| 12" | IRR050-1200-80 | IRR075-1200-80 | IRR100-1200-80 | IRR200-1200-80 |
| 18" | IRR050-1800-80 | IRR075-1800-80 | IRR100-1800-80 | IRR200-1800-80 |
| 24" | IRR050-2400-80 | IRR075-2400-80 | IRR100-2400-80 | IRR200-2400-80 |
| 36" | IRR050-3600-80 | IRR075-3600-80 | IRR100-3600-80 | IRR200-3600-80 |

MAINLINE REPAIR PARTS

Order Online At Parwest.com



- We carry a full selection of mainline repair parts from Leemco, Smith Blair And Romac
- There are too many options to list, so call us and we will find you the exact part you need



SMITH BLAIR 313 SADDLE

Double Bale

- The wide saddle body provides stability on the pipe
- The gasket is fully bonded to the cavity to hold it in place
- NPT threaded outlets available in sizes 1" thru 4"
- A closed lug on one side, combined with the bale, acts as a hinge for easier installation



SMITH BLAIR 317 SADDLE

Double Bale Stainless

- The wide saddle body provides stability on the pipe
- Designed with PVC and other soft or brittle pipe in mind
- The gasket fully bonds to the cavity to hold it in place
- NPT threaded outlets available in sizes 1" thru 4"
- Wide bands spread the load over larger area to prevent damage to the pipe when tightening the straps



SMITH BLAIR 461 STANDARD LENGTH QUANTUM COUPLINGS

226 SINGLE BAND FULL CIRCLE® REPAIR CLAMPS



Pricing is subject to change.

14 GAUGE DIRECT BURIAL IRRIGATION WIRE
500 Foot Spool



- IRRWY14-500 YELLOW
- IRRB14-500 BLACK
- IRRWR14-500 RED
- IRRWW14-500 WHITE
- IRRWBL14-500 BLUE
- IRRW14-500 ORANGE
- IRRW14-500 PURPLE



WIRING TOOLS
Channellock



- CHA447 DIAGONAL WIRE CUTTER
- CHA959 WIRE STRIPPER & CRIMPER
- CHA908 WIRE STRIPPER & CRIMPER

DIRECT BURIAL SPLICE KITS
Waterproof Connectors



- IRRD BRY SPLICE KIT
- IRRD BRY-100 BAG OF 100



3M RED/YELLOW WIRE NUTS
Bag of 100 Wire Nuts



SHPWN-YR

IRRIGATION TESTER KIT



- Troubleshoot irrigation systems
- Activate and cycle solenoids
- Test solenoids for continuity
- Send tone to identify wires
- Measure clock voltage
- Easy-to-understand LEDs

IRR24BK

WIRE LOCATER/TRACER



- Traces the path and determines the depth of wires
- Lightweight receiver provides audible and visual indications of signal strength
- Transmitter output and receiver sensitivity are fully adjustable for maximum accuracy
- Molded carrying case included

IRRWL501

PULSE FAULT LOCATER



- Identifies the exact location of even the smallest breaks in insulation
- Multiple faults on a single wire can be identified indicating the need to replace instead of repair
- Molded carrying case included

IRRPE2003-G

RAINBIRD PAR+ ES BOARD EXCHANGES & REPAIRS

Reconditioned Parts



1

| | | | |
|---|-----------------------|-----------------------|---------------------------------------|
| 1 | IRRRB635711 | PAR+ ES | TIMING MECHANISM |
| 2 | IRRRB635513-00 | PAR+ ES | POWER INTERCONNECT - 48 STATION |
| 2 | IRRRB635513-01 | PAR+ ES | POWER INTERCONNECT - 72 STATION |
| 3 | IRRRB635121 | PAR+ ES | TERMINAL STRIP BOARD - STA 1-24 |
| 3 | IRRRB635124 | PAR+ ES | TERMINAL STRIP BOARD - STA 25-48 |
| 3 | IRRRB635560 | PAR+ ES | TERMINAL STRIP BOARD - STA 49-72 |
| 4 | IRRRB634677-01 | PAR+ ES / PAR+ / MSC+ | OUTPUT STATION MODULE - NO SWITCHES |
| 4 | IRRRB634677-02 | PAR+ ES / PAR+ / MSC+ | OUTPUT STATION MODULE - WITH SWITCHES |
| 5 | IRRRB633280 | PAR+ ES / PAR+ / MSC+ | LINK INTERFACE BOARD |



2



3



4



5



6

RAINBIRD PAR+ BOARD EXCHANGES & REPAIRS

Reconditioned Parts



1

| | | | |
|---|-----------------------|-----------------------|-------------------------------------|
| 1 | IRRRB633224 | PAR+ | TIMING MECHANISM |
| 2 | IRRRB633513-02 | PAR+ | POWER INTERCONNECT |
| 3 | IRRRB633608 | PAR+ / MSC+ | TERMINAL STRIP BOARD - STA 1-24 |
| 3 | IRRRB633610 | PAR+ / MSC+ | TERMINAL STRIP BOARD - STA 25-48 |
| 4 | IRRRB634677-01 | PAR+ ES / PAR+ / MSC+ | OUTPUT STATION MODULE - NO SWITCHES |
| 4 | IRRRB634677-02 | PAR+ ES / PAR+ / MSC+ | OUTPUT STATION MODULE - W/ SWITCHES |
| 5 | IRRRB633653 | PAR+ / MSC+ | RELAY OUTPUT MODULE |
| 6 | IRRRB633280 | PAR+ ES / PAR+ / MSC+ | LINK INTERFACE BOARD |



2



3



4



5



6

PAR WEST BOARD EXCHANGE

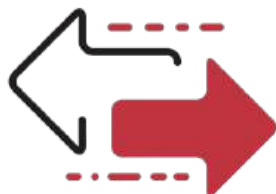

CONVENIENCE - QUALITY - SIMPLICITY

- Order the boards you need
- We will ship you reconditioned boards with a return label in the box
- Put your old board back in the box and send it back

We Carry a Full Line of Controller Parts

- Cables
- Power supplies
- Pedestals
- Radios
- Antennas
- Check our website for more options

Pricing is subject to change.

**PAR WEST
BOARD EXCHANGE**

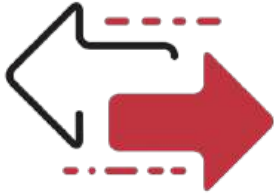

- Order the boards you need
- We will ship you reconditioned boards with a return label in the box
- Put your old board back in the box and send it back

SIMPLE AND CONVENIENT

QUALITY YOU CAN COUNT ON

All Boards Go Through The Following Process

- Every board receives a complete tear down and thorough cleaning
- All broken and damaged parts are identified and replaced
- Every board gets tested and approved before going back into the field
- We stand behind every board with a 1 year warranty

RAINBIRD MSC BOARD EXCHANGES & REPAIRS

Reconditioned Parts



1



2



3



4



5

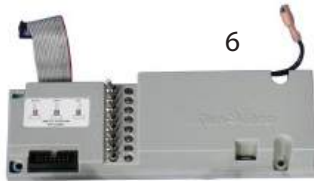

6

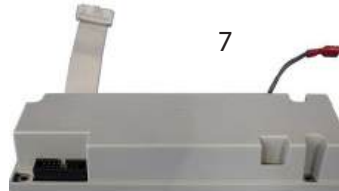

7



8

| | | | |
|---|-----------------------|-----------------------|---------------------------------------|
| 1 | IRRRB634955 | MSC+ | TIMING MECHANISM |
| 2 | IRRRB631388-01 | MSC 16 | TIMING MECHANISM |
| 2 | IRRRB631388-02 | MSC 24 | TIMING MECHANISM |
| 3 | IRRRB635513-02 | MSC+ | POWER INTERCONNECT |
| 4 | IRRRB633608 | MSC+ / PAR+ | TERMINAL STRIP BOARD - STA 1-24 |
| 4 | IRRRB633610 | MSC+ / PAR + | TERMINAL STRIP BOARD - STA 25-48 |
| 5 | IRRRB631550 | MSC 16 & 24 | TERMINAL STRIP BOARD |
| 6 | IRRRB634677-01 | PAR+ ES / PAR+ / MSC+ | OUTPUT STATION MODULE - NO SWITCHES |
| 6 | IRRRB634677-02 | PAR+ ES / PAR+ / MSC+ | OUTPUT STATION MODULE - WITH SWITCHES |
| 7 | IRRRB633653 | PAR+ ES / PAR+ / MSC+ | RELAY OUTPUT MODULE |
| 8 | IRRRB633280 | PAR+ ES / PAR+ / MSC+ | LINK INTERFACE BOARD |

RAINBIRD RADIO MODEM BOARD EXCHANGE & REPAIR



| | | | |
|---|--------------------|-----------------------------------|-------------|
| 1 | IRRRB634433 | PAR+ / PAR / MSC / MSC+ / PAR+ ES | RADIO MODEM |
|---|--------------------|-----------------------------------|-------------|



1



2

TORO VP BOARD EXCHANGES & REPAIRS

Reconditioned Parts

| | | | |
|---|------------------------|----|--------------------------------|
| 1 | IRRT102-3497 | VP | TIMING MECHANISM |
| 2 | IRRT102-2782 | VP | DISTRIBUTION BOARD |
| 3 | IRRT102-0104-01 | VP | MODEM BOARD - SINGLE CONNECTOR |
| 3 | IRRT102-0104-02 | VP | MODEM BOARD - THREE CONNECTORS |
| 4 | IRRT102-3015 | VP | PUMP COMMON BOARD |
| 5 | IRRT102-2549 | VP | OUTPUT STATION BOARD |
| 6 | IRRT102-0640 | VP | SWITCH AND SURGE BOARD |



3



4



5



6



1



2

TORO LTC 1.0 - 2.0 BOARD EXCHANGES & REPAIRS

Reconditioned Parts

| | | | |
|---|--------------------|-------------------|--|
| 1 | IRRT91-2337 | LTC 1.0 | TIMING MECHANISM - NO TERMINAL BLOCK IN PEDESTAL |
| 1 | IRRT91-0545 | LTC 1.0 | TIMING MECHANISM - TERMINAL BLOCK COMMONLY IN PEDESTAL |
| 2 | IRRT89-7169 | LTC 2.0 | TIMING MECHANISM |
| 3 | IRRT91-0777 | LTC 1.0 | MODEM BOARD |
| 3 | IRRT89-7852 | LTC 2.0 | MODEM BOARD |
| 4 | IRRT91-1303 | LTC 1.0 | 8 STATION BOARD W/ SURGE PROTECTION |
| 5 | IRRT89-7170 | LTC 2.0 | STATION OUTPUT BOARD |
| 6 | IRRT91-1305 | LTC 1.0 | PUMP COMMON BOARD |
| 7 | IRRT89-7171 | LTC 2.0 | PUMP COMMON BOARD |
| 8 | IRRT91-1307 | LTC 1.0 / LTC 2.0 | SURGE PROTECTION - COMMUNICATION |
| 9 | IRRT89-6977 | LTC 2.0 | DISTRIBUTION BOARD |



3



4



6



8



5



7



9

Pricing is subject to change.

TORO LTC PLUS BOARD EXCHANGES & REPAIRS

Reconditioned Parts



1

- 1 **IRRT102-0238** LTC+ TIMING MECHANISM
- 2 **IRRT102-0681** LTC+ 8 STATION OUTPUT BOARD
- 3 **IRRT89-7852** LTC+ MODEM BOARD
- 4 **IRRT102-0612** LTC+ DISTRIBUTION BOARD
- 5 **IRRT102-8078** LTC+ SWITCH & SURGE BOARD - NO SWITCHES OR SURGE
- 5 **IRRT102-8079** LTC+ SWITCH & SURGE BOARD - SWITCHES ONLY
- 5 **IRRT102-8080** LTC+ SWITCH & SURGE BOARD - SWITCHES AND SURGE



2



3

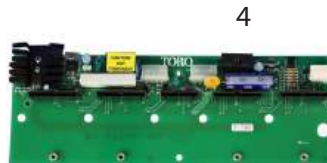

4



5



6

TORO NETWORK 8000 BOARD EXCHANGES & REPAIRS

Reconditioned Parts



1

- 1 **IRRT91-1280** NETWORK 8000 TIMING MECHANISM
- 2 **IRRT35-6166** NETWORK 8000 POWER SUPPLY
- 3 **IRRT35-8646** NETWORK 8000 MODEM BOARD
- 4 **IRRT35-8000** NETWORK 8000 TRIAC BOARD - SINGLE BOARD
- 5 **IRRT89-8100** NETWORK 8000 TRIAC BOARD - TWO TIER
- 6 **IRRT35-6326** NETWORK 8000 PUMP / CURRENT MONITOR
- 7 **IRRT35-8502** NETWORK 8000 VALVE VOLTAGE MONITOR
- 8 **IRRT35-8652** NETWORK 8000 DISTRIBUTION BOARD
- 9 **IRRT118-1524** NETWORK 8000 COMMUNICATION SURGE BOARD



2



3



4



5



6



7



8



9

PAR WEST BOARD EXCHANGE



CONVENIENCE - QUALITY - SIMPLICITY

- Order the boards you need
- We will ship you reconditioned boards with a return label in the box
- Put your old board back in the box and send it back

WE CARRY MORE OPTIONS

- Osmac board and parts
- Cables
- Power supplies
- See website for more options

SAFETY NET



- The 6-½ ft. x 6 ft. (1.98 m x 1.83 m) net provides ample protection for employees doing work in the line of fire.
- Collapsible frame has aluminum uprights with fiberglass upper and lower cross pieces and heavy-duty step-in stakes that secure the uprights.
- The net is high-strength polypropylene with high-visibility safety yellow borders.

PAR1100

ISOLATION VALVE KEYS & PROBES

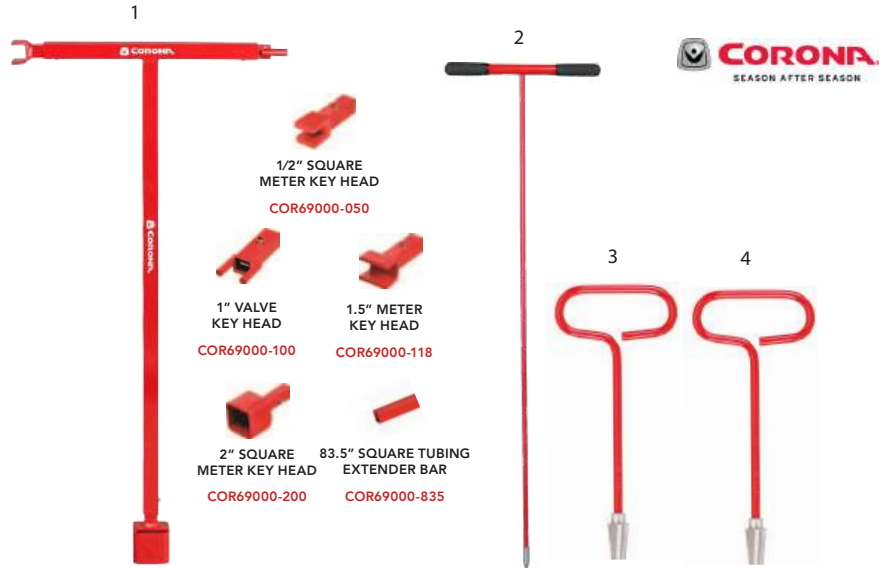

- 1 **CORUT69000** MULTI USE KEY - MAINLINE, METER AND SPRINKLER VALVE 3FT- 5FT
- 2 **CORUT64050** 48" SOIL PROBE - LOCATE VALVE BOXES OR SPRINKLERS
- 3 **CORUT65001** 1 INCH AND 1.25 INCH EZ-OUT
- 4 **CORUT65002** 1/2 INCH AND 3/4 INCH EZ-OUT

MICHIGAN AXE

Solid-Core
Fiberglass Handle



CORAX70020

PICK MATTOCK

36" Hickory Handle
w/ Poly Guard



CORPM41000



8 LB. SLEDGEHAMMER

32" Solid-Core
Fiberglass Handle



CORST70021

12 LB. SLEDGEHAMMER

34" Solid-Core
Fiberglass Handle



CORST70024

GROUND ZERO II Irrigation Leveling



Convenient folding design makes the GZ II easy to use, carry, and store, with arms spanning 54". Built from high-quality steel, it's virtually indestructible. Perfect for irrigation installs or resetting heads and boxes to prevent mower damage and improve efficiency.



FOLDING DESIGN

- Indispensable tool for leveling and holding irrigation heads and valve boxes
- Ideal device for golf course, sports field or other grounds area irrigation projects
- Convenient folding design makes it easy to use, carry and store
- Use for initial installation or resetting
- 54" (137 cm) steel arms are virtually indestructible

PAR525540

Pricing is subject to change.

2 IN 1 INNER-OUTER PVC DEBURRING TOOL
Pipe Deburring Reamer Plumbing Tool



IRRDT

ADJUSTABLE WRENCH
Channellock



- CHA804 4" WRENCH
- CHA806W 6" WRENCH
- CHA808W 8" WRENCH
- CHA812W 12" WRENCH

6 PIECE SCREWDRIVER SET
Channellock



CHASD-6H

12" HIGH TENSION HACKSAW



SEY41442 HACKSAW

36" CABLE SAW



KEN41448

TONGUE AND GROOVE PLIERS
Channellock



- CHA430 10"
- CHA440 12"
- CHA460 16"

STEEL PIPE WRENCH



- SEY41602 18" LENGTH
- SEY41604 24" LENGTH

2" PROFESSIONAL PVC PIPE CUTTER



SEY41436

PVC PIPE CUTTER



CORUT65050

HEAD TRIMMER ATTACHMENTS FOR STRING TRIMMERS

- We have every type of trimmer attachment to make edging sprinklers, valve boxes and yardage markers a breeze
- Easily mount to all major brands of trimmers
- Save time and money by speeding up the process of trimming heads
- We have optional mounting kits to provide all of the hardware needed to mount a trimmer head

PLASTIC HEAD TRIMMERS



- One-piece nylon unit with four vertical blades.
- 24 vanes create a vacuum, pulling the grass into the blades and distributing it away from the sprinkler head.

| | |
|-----------------|-----------|
| SHPPH6 | 6" HEAD |
| SHPPH6.5 | 6.5" HEAD |
| SHPPH7.5 | 7.5" HEAD |
| SHPPH10 | 10" HEAD |

METAL IRRIGATION HEAD TRIMMERS



- Super heavy-duty steel construction
- Blades for all size heads, valve boxes, yardage markers available
- 1" or 20 mm arbor holes fit nearly every trimmer

| | |
|-----------------|-----------|
| SHPTH7 | 7" HEAD |
| SHPTH7.5 | 7.5" HEAD |
| SHPTH8 | 8" HEAD |
| SHPTH8.5 | 8.5" HEAD |
| SHPTH10 | 10" HEAD |

HEAD TRIMMER MOUNTING KITS



- We always try to make things easier for our customers and here we did it again
- Mounting kits for major trimmer brands that will mount any blade to your unit

| | |
|------------------|-----------|
| SHPTH-ECH | ECHO |
| SHPTH-SHN | SHINDAIWA |
| SHPTH-STL | STIHL |

IRRIGATION HEAD TRIMMER



- Trim thick grass - even removes roots - around irrigation heads or yardage markers.
- One handle works with a wide range of head sizes.
- Plated-steel construction.

| | |
|-----------------|-------------|
| STD29900 | HANDLE ONLY |
| STD29905 | 5" HEAD |
| STD29906 | 6" HEAD |
| STD29907 | 7" HEAD |
| STD29908 | 8" HEAD |
| STD29909 | 9" HEAD |
| STD29910 | 10" HEAD |
| STD29911 | 11" HEAD |

UNDERHILL TURBO TRIM Pro Ratchet Series

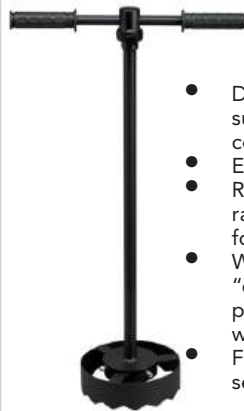

- Durable materials, super heavy-duty steel construction
- Easy to use
- Reversible left or right ratcheting function makes for faster, cleaner cuts
- Wide "T" handle provides "centered" operator position to prevent wobbling or uneven cuts
- Fits most golf sprinkler series

| | |
|--------------------|----------|
| IRRTT-100 | HANDLE |
| IRRTTRC-007 | 7" HEAD |
| IRRTTRC-008 | 8" HEAD |
| IRRTTRC-011 | 11" HEAD |

ACCUFORM ACCUTRIM



- Power irrigation head trimmer - attaches to any cordless drill (drill not included)
- Multiple cutting head sizes for universal fit on Toro, Rainbird and Hunter irrigation heads
- Built-in spacer controls cutting depth to prevent solenoid damage
- Heavy-duty steel construction

| | |
|-------------------|---------------------|
| PAR13280 | ACCUTRIM DRIVE TOOL |
| PAR13280-1 | 7.75" HEAD |
| PAR13280-2 | 7.25" HEAD |
| PAR13280-3 | 6.9" HEAD |
| PAR13280-4 | 5.0" HEAD |

Pricing is subject to change.



POWER GULP BATTERY-POWERED PUMP

Power Gulp delivers an impressive 11 GPM, even in the murkiest waters. No more struggling with clogs or weak flow – MudGuard technology filters out debris, ensuring smooth operation where other pumps fail.

Underhill Battery & Charger

- 4 Amp Hr. 18 Volt battery
- Slides into stock plate on Power Gulp Battery only or Battery and Charger

Interchangeable battery plates allow pump to operate with most 18V-20 slide-style batteries from Milwaukee, Makita, DeWALT, and Bosch (pump comes standard with Bosch® plate)

- Versatility at its finest: Use interchangeable battery plates (sold separately) compatible with major brands like Milwaukee, DeWalt, Makita, or Bosch.
- Adaptable discharge options: Choose Gulp tubing, 3/4" hose, or 1" hose with included adapters.
- Unmatched endurance: Enjoy up to 60 minutes of continuous pumping per charge.
- Unrivaled performance in dirty water: Where others struggle, Power Gulp excels.

3 Discharge Hose Options To Choose From:
3/4" GHT garden hose,
1" NPSH water hose, &
1 5/8" Gulp Tubing



IRRA-PG-18V

IRR-PG-APBO

IRR-PG-APDE

IRR-PG-APMA

IRR-PG-APMI

IRR-PG-BAT

IRR-PG-BATCH

IRRA-PG-QS

IRRA-PG-CT-10

POWER GULP UNIT W/O BATTERY

BOSCH ADAPTER PLATE

DEWALT ADAPTER PLATE

MAKITA ADAPTER PLATE

MILWAUKEE ADAPTER PLATE

UNDERHILL 18V X 4.0A BATTERY

UNDERHILL 18V X 4.0A BATTERY + CHARGER

QUICK STAND

CORRUGATED DISCHARGE TUBING



Power Gulp Pump Recommended Uses



Pool & Spas



Irrigation Repairs



Golf Courses & Landscape



Valve Boxes



Catch Basins



Ponds & Fountains

Battery not included with purchase!

GULP SYRINGE IRRA-G125-C



BIG GULP ULTRAMAX HAND PUMP

36" PUMP W/ 72" DISCHARGE HOSE

IRRA-G3672-CK

GULP ULTRAMAX PLUS

21" PUMP W/ 36" DISCHARGE HOSE

IRRA-G1236-C



BIG GULP ULTRAMAX MUD GUARD

- Comes standard with ultramax pumps
- Can be purchased separately as well
- Built in filter minimizes clogging and makes pumping easier
- Easy on and off for cleaning



IRRA-GMG MUD GUARD ONLY



1" WATER PUMP



3" SEMI-TRASH PUMP



2" SEMI-TRASH PUMP



3" FULL PUMP

WATER AND TRASH PUMPS Gas Powered Predator Engine

- Water or trash pumps available
- Trash pumps can handle light debris without damage to pump
- Choose size based on capacity needs
- Hoses and fittings available
- California compliant
- **All pump options use Predator branded engines**

PUMP DESCRIPTION GUIDE

| TYPE | GOLF COURSE USE |
|------------------------|---|
| WATER PUMP | Clean water transfer or irrigation tasks. |
| SEMI-TRASH PUMP | Puddles or debris in fairways or bunkers. |
| FULL PUMP | Floodwater and heavily debris-filled areas. |

| PART # | PUMP TYPE | INLET/OUTLET SIZE | DISCHARGE MAX HEAD | SUCTION MAX HEAD | DISCHARGE GPM | ENGINE CC |
|-------------------|------------|-------------------|--------------------|------------------|---------------|-----------|
| 1. IRRWP1 | WATER | 1 INCH | 95 FEET | 19 FEET | 35 GPM | 79 CC |
| 2. IRRSTP2 | SEMI-TRASH | 2 INCH | 91 FEET | 26 FEET | 158 GPM | 212 CC |
| 3. IRRSTP3 | SEMI-TRASH | 3 INCH | 85 FEET | 26 FEET | 290 GPM | 212 CC |
| 4. IRRFTP3 | FULL | 3 INCH | 88 FEET | 23 FEET | 385 GPM | 301 CC |

SUCTION AND DISCHARGE HOSES

For All Water And Trash Pumps

COMPLETE HOSE KITS

Hose pump kits include 65' blue PVC discharge hose, 20' green PVC suction hose, steel round hole suction strainer & cam and groove adapters for hose and pump

- IRHK1** 1" COMPLETE HOSE KIT
- IRHK2** 2" COMPLETE HOSE KIT
- IRHK3** 3" COMPLETE HOSE KIT

SUCTION HOSE

- IRRS120G** 1" X 20' GREEN SUCTION W/ ALUMINUM/BRASS THREADED ENDS
- IRRS320G** 3" X 20' GREEN SUCTION W/ ALUMINUM/BRASS THREADED ENDS

DISCHARGE HOSE -25'

- IRRDH125R** 1" X 25' PVC DISCHARGE W/ ALUMINUM/BRASS THREADED ENDS
- IRRDH225R** 2" X 25' PVC DISCHARGE W/ ALUMINUM/BRASS THREADED ENDS
- IRRDH325R** 3" X 25' PVC DISCHARGE W/ ALUMINUM/BRASS THREADED ENDS

DISCHARGE HOSE -50'

- IRRDH250R** 2" X 50' PVC DISCHARGE W/ ALUMINUM/BRASS THREADED ENDS
- IRRDH350R** 3" X 50' PVC DISCHARGE W/ ALUMINUM/BRASS THREADED ENDS



COMPLETE HOSE KIT



SUCTION HOSE



DISCHARGE HOSE

PORTA PUMP
Clear Water Quickly And Easily



- Golf Bunkers- Clear standing water in minutes.
- Irrigation Breaks/Leaks: Quickly empty flooded irrigation head blow outs or line breaks.
- Cart Paths/ Walking Trails/ Bike Path - quickly clear and standing water from low lying areas in the cart path.
- Clogged Drains: Quickly clear away water from clogged drain areas so that you can identify and quickly fix the problem.
- Water Pipe Breaks:- clear the water quickly while other workers identify and fix the problem.
- SPORTS FIELDS: Quickly clear standing water from low lying areas around bases, home plate or high traffic areas.

PPH-35 COMPLETE KIT



12 VOLT ELECTRIC BUNKER PUMP

- Includes 12 volt submersible pump with 8 feet of cord and alligator clip extensions available
- High Volume Complete Kit pumps 78 GPM and includes 25 feet X 2 inch discharge hose
- Kit is ready to go - hook to utility vehicle or sand pro battery and get nuisance water out of bunkers quickly

ACUSP02

HIGH VOLUME PUMP ONLY - 4700 GPM

IRRDH2-25B

DISCHARGE HOSE, 2 INCH X 25 FT. LONG, LAYFLAT W/ CLAMP

IRRDH2-50B

DISCHARGE HOSE, 2 INCH X 50 FT. LONG, LAYFLAT W/ CLAMP

TLTSHU-WH

WIRE HARNESS, 10 FT. LONG W/ CONNECTION PLUG & ALLIGATOR CLIPS

IRRBP-HV

HIGH VOLUME COMPLETE KIT W/ 2 INCH X 25 FT. DISCHARGE HOSE

PORTA PUMP JUNIOR

Converts Weedeater Into Pump



PPH-SQ-KIT COMPLETE KIT - SQUARE SHAFT

PPH-SP-KIT COMPLETE KIT - SPLINED SHAFT

PPH-JR-SQ PORTA PUMP ONLY - SQUARE SHAFT

PPH-JR-SP PORTA PUMP ONLY - SPLINED SHAFT

- Up to 30 GPM (depending on engine size)
- Minimum engine size required is 1 HP
- Self-priming
- 4 lbs. and 1.25" discharge
- Porta Pump Junior comes in square or splined shaft models. Echo & Stihl trimmers require square shaft. Shindaiwa requires splined shaft
- Two part numbers available - complete kit includes discharge hose and options wire mesh screen to keep out smaller particles (great for bunkers)

The PortaPump Junior is a commercial grade pump that will fit on to any brand of string trimmer or brushcutter.



VFX SERIES AERATION FOUNTAINS

1/2HP, 3/4HP, 1HP, 2HP, & 5HP

DRAMATICALLY IMPROVE YOUR WATER QUALITY!

- The best of both beautiful eye-catching displays and aeration
- 120V and 208-240V, single and three phase options
- One-piece float blends with water's surface and is easy to install
- Bottom screen helps prevent clogging
- Manage from shore with human-rated, GFCI-protected control panel



| HP | DISPLAY | | CORD | 50 FT | 100 FT | 150 FT | 200 FT | 250 FT | 300 FT | 400 FT | 500 FT |
|--|---------|--------|---------------|-----------------------|-----------------------|-----------------------|-----------------------|-----------------------|-----------------------|-----------------------|-----------------------|
| | H (FT) | W (FT) | | | | | | | | | |
| 120V, SINGLE PHASE PACKAGES | | | | | | | | | | | |
| 1/2 | 5 | 15 | PART # | KAS2400VFX050 | KAS2400VFX100 | KAS2400VFX150 | KAS2400VFX200 | -- | -- | -- | -- |
| | | | PRICE | | | | -- | -- | -- | -- | |
| 3/4 | 5.5 | 21 | PART # | KAS3400VFX050 | KAS3400VFX100 | KAS3400VFX150 | KAS3400VFX200 | -- | -- | -- | -- |
| | | | PRICE | | | | -- | -- | -- | -- | |
| 1 | 8 | 26 | PART # | KAS4400VFX050 | KAS4400VFX100 | KAS4400VFX150 | KAS4400VFX200 | -- | -- | -- | -- |
| | | | PRICE | | | | -- | -- | -- | -- | |
| 208-240V, SINGLE PHASE PACKAGES | | | | | | | | | | | |
| 3/4 | 5.5 | 21 | PART # | KAS3400HVFX050 | KAS3400HVFX100 | KAS3400HVFX150 | KAS3400HVFX200 | KAS3400HVFX250 | KAS3400HVFX300 | KAS3400HVFX400 | KAS3400HVFX500 |
| | | | PRICE | | | | | | | | |
| 1 | 8 | 26 | PART # | KAS4400HVFX050 | KAS4400HVFX100 | KAS4400HVFX150 | KAS4400HVFX200 | KAS4400HVFX250 | KAS4400HVFX300 | KAS4400HVFX400 | KAS4400HVFX500 |
| | | | PRICE | | | | | | | | |
| 208-240V, SINGLE PHASE PACKAGES | | | | | | | | | | | |
| 2 | 8 | 32 | PART # | KAS8400VFX050 | KAS8400VFX100 | KAS8400VFX150 | KAS8400VFX200 | KAS8400VFX250 | KAS8400VFX300 | KAS8400VFX400 | KAS8400VFX500 |
| | | | PRICE | | | | | | | | |
| 5 | 9 | 34 | PART # | -- | KAS5.1VFX100 | KAS5.1VFX150 | KAS5.1VFX200 | KAS5.1VFX250 | KAS5.1VFX300 | KAS5.1VFX400 | KAS5.1VFX500 |
| | | | PRICE | -- | | | -- | | | | |
| 208-240V, THREE PHASE PACKAGES | | | | | | | | | | | |
| 2 | 8 | 32 | PART # | KAS2.3VFX050 | KAS2.3VFX100 | KAS2.3VFX150 | KAS2.3VFX200 | KAS2.3VFX250 | KAS2.3VFX300 | KAS2.3VFX400 | KAS2.3VFX500 |
| | | | PRICE | | | | | | | | |
| 5 | 9 | 34 | PART # | -- | KAS5.3VFX100 | KAS5.3VFX150 | KAS5.3VFX200 | KAS5.3VFX250 | KAS5.3VFX300 | KAS5.3VFX400 | KAS5.3VFX500 |
| | | | PRICE | -- | | | | | | | |

1/2HP, 3/4HP, & 1HP Product Notes:

*1/2HP can operate in 15 in. of water. 3/4HP can operate in 17.5 in. of water. 1HP can operate in 19 in. of water.

1. Prices in bold have quick disconnect installed on power cords.
2. 1/2, 3/4, and 1HP, 120V, single phase units include C-25 control panel.
3. 3/4 and 1HP, 208-240V, single phase units include C-85 control panel.
4. Solar-powered option available. Contact us for details.

2HP & 5HP Product Notes:

*2HP can operate in 20 in. of water. 5HP can operate in 26 in. of water. ** Extended warranty available on 2HP and 5HP units.

1. Prices in bold have quick disconnect installed on power cords.
2. 2HP, single phase units include C-85 control panel. 5HP, single phase units include C-95 control panel.
3. 2 and 5HP, three phase units include CF-3235 control panel.

4. Three phase units are constructed with a durable stainless steel motor top for reliable performance in all environments.
5. Mesh lining (included) around bottom screen further helps prevent clogging.
6. 460-480V, three phase option available for special order in approved locations only.
7. Solar-powered option available for 2HP, three phase units. Contact us for details.

Pricing is subject to change.



J SERIES FOUNTAINS
3/4HP, 1HP, & 2HP

FOR SMALL TO MEDIUM SIZED PONDS



- 120V and 208-240V, single and three phase options
- 1-piece float blends in with water's surface and is easy to install
- Composite bottom screen helps prevent clogging
- Premium Nozzles available separately (see pages 16-17)
- Manage from shore with included human-rated, GFCI-protected control panel

| HP | DISPLAY | | CORD | 50 FT | 100 FT | 150 FT | 200 FT | 250 FT | 300 FT | 400 FT | 500 FT |
|----|---------|--------|------|-------|--------|--------|--------|--------|--------|--------|--------|
| | H (FT) | W (FT) | | | | | | | | | |

120V, SINGLE PHASE PACKAGES

| | | | | | | | | | | | |
|-----|-----|----|---------------|---------------------|---------------------|---------------------|---------------------|----|----|----|----|
| 3/4 | 5.5 | 21 | PART # | KAS3400JF050 | KAS3400JF100 | KAS3400JF150 | KAS3400JF200 | -- | -- | -- | -- |
| | | | PRICE | | | | -- | -- | -- | -- | |
| 1 | 8 | 26 | PART # | KAS4400JF050 | KAS4400JF100 | KAS4400JF150 | KAS4400JF200 | -- | -- | -- | -- |
| | | | PRICE | | | | -- | -- | -- | -- | |

208-240V, SINGLE PHASE PACKAGES

| | | | | | | | | | | | |
|-----|-----|----|---------------|----------------------|----------------------|----------------------|----------------------|----------------------|----------------------|----------------------|----------------------|
| 3/4 | 5.5 | 21 | PART # | KAS3400HJF050 | KAS3400HJF100 | KAS3400HJF150 | KAS3400HJF200 | KAS3400HJF250 | KAS3400HJF300 | KAS3400HJF400 | KAS3400HJF500 |
| | | | PRICE | | | | | | | | |
| 1 | 8 | 26 | PART # | KAS4400HJF050 | KAS4400HJF100 | KAS4400HJF150 | KAS4400HJF200 | KAS4400HJF250 | KAS4400HJF300 | KAS4400HJF400 | KAS4400HJF500 |
| | | | PRICE | | | | | | | | |

208-240V, SINGLE PHASE PACKAGES

| | | | | | | | | | | | |
|---|---|----|---------------|---------------------|---------------------|---------------------|---------------------|---------------------|---------------------|---------------------|---------------------|
| 2 | 8 | 32 | PART # | KAS8400JF050 | KAS8400JF100 | KAS8400JF150 | KAS8400JF200 | KAS8400JF250 | KAS8400JF300 | KAS8400JF400 | KAS8400JF500 |
| | | | PRICE | | | | | | | | \$12,537.50 |

208-240V, THREE PHASE PACKAGES

| | | | | | | | | | | | |
|---|---|----|---------------|--------------------|--------------------|--------------------|--------------------|--------------------|--------------------|--------------------|--------------------|
| 2 | 8 | 32 | PART # | KAS2.3JF050 | KAS2.3JF100 | KAS2.3JF150 | KAS2.3JF200 | KAS2.3JF250 | KAS2.3JF300 | KAS2.3JF400 | KAS2.3JF500 |
| | | | PRICE | | | | | | | | |

1/2HP, 3/4HP, 1HP, & 12HP Product Notes:

*1/2HP, 3/4HP, 1HP Packages come with 4 twist-and-lock nozzles (Cypress, Linden, Sequoia, and Birch). The Willow pattern is achieved by operating the fountain without a nozzle. 2HP Packages include 5 twist-and-lock nozzles (Balsam, Linden, Birch, Spruce, and Redwood).

**3/4HP units operate in as little as 17.5 in. of water. 1HP units operate in as little as 19 in. of water. 2HP units operate in as little as 20 in. of water. 3HP units operate in as little as 24 in. of water.

1. Prices in bold have quick disconnect installed on power cords.
2. 3/4 and 1HP, 120V single phase options include C-25 control panel.
3. 3/4 and 1HP, 208-240V single phase options include C-85 control panel.
4. 2HP, single phase units utilize stainless steel top and bottom screens, and composite motor top and legs.
5. 2HP, three phase units utilize stainless steel top and bottom screens, motor top, legs, and stub cord protective sleeving.
6. 2HP, single phase options include C-85 control panel. 3HP, single phase options include C-95 control panel.
7. 2HP, three phase units include CF-3235 control panel.
8. 460-480V, three phase options available for special order in approved locations only.

PREMIUM J SERIES NOZZLES

Available For All HP Sizes. Purchased Separately



Ready to Upgrade Your Nozzles?

Call Us Today for More Info!



PARWEST.COM | 714-893-1555

PAR WEST



J SERIES FOUNTAINS 3HP, 5HP, & 7.5HP



FOR LARGE SIZED PONDS

- 120V and 208-240V, single and three phase options
- 1-piece float blends in with water's surface and is easy to install
- Composite bottom screen helps prevent clogging
- Premium Nozzles available separately (see pages 16-17)
- Manage from shore with included human-rated, GFCI-protected control panel

| HP | DISPLAY | | CORD | 50 FT | 100 FT | 150 FT | 200 FT | 250 FT | 300 FT | 400 FT | 500 FT |
|--|---------|--------|---------------|--------------------|--------------------|--------------------|---------------------|---------------------|---------------------|---------------------|---------------------|
| | H (FT) | W (FT) | | | | | | | | | |
| 208-240V, SINGLE PHASE PACKAGES | | | | | | | | | | | |
| 3 | 8 | 32 | PART # | KAS3.1JF050 | KAS3.1JF100 | KAS3.1JF150 | KAS3.1JF200 | KAS3.1JF250 | KAS3.1JF300 | KAS3.1JF400 | KAS3.1JF500 |
| | | | PRICE | | | | | | | | |
| 208-240V, THREE PHASE PACKAGES | | | | | | | | | | | |
| 3 | 8 | 32 | PART # | KAS3.3JF050 | KAS3.3JF100 | KAS3.3JF150 | KAS3.3JF200 | KAS3.3JF250 | KAS3.3JF300 | KAS3.3JF400 | KAS3.3JF500 |
| | | | PRICE | | | | | | | | |
| 208-240V, SINGLE PHASE PACKAGES | | | | | | | | | | | |
| 5 | 9 | 34 | PART # | -- | KAS5.1JF100 | KAS5.1JF150 | KAS5.1JF200 | KAS5.1JF250 | -- | -- | -- |
| | | | PRICE | -- | | | | | | -- | -- |
| 208-240V, THREE PHASE PACKAGES | | | | | | | | | | | |
| 7 | 9 | 34 | PART # | -- | KAS7.3JF100 | KAS7.3JF150 | KAS5.3VFX200 | KAS5.3VFX250 | KAS5.3VFX300 | KAS5.3VFX400 | KAS5.3VFX500 |
| | | | PRICE | -- | | | | | | | |

3HP, 5HP, & 7.5HP Product Notes:

*Packages include 5 twist-and-lock nozzles (Balsam, Linden, Birch, Spruce, and Redwood).

**3HP units operate in as little as 24 in. of water. 5HP units operate in as little as 26 in. of water. 7.5HP units operate in as little as 28 in. of water.

1. Prices in bold have quick disconnect installed on power cords.
2. 3HP, single phase units utilize stainless steel top and bottom screens, and composite motor top and legs.
3. 3HP, three phase units utilize stainless steel top and bottom screens, motor top, legs, and stub cord protective sleeving.
4. 3HP, single phase options include C-85 control panel. 3HP, single phase options include C-95 control panel.
5. 3HP, three phase units include CF-3235 control panel.
6. All 5 and 7.5HP units utilize stainless steel top and bottom screens, motor top, legs, and protective stub cord sleeving.
7. 5HP, single phase units include C-95 control panel. 5HP, three phase units include CF-3235 control panel.
8. 7.5HP, three phase units include CF-3075 control panel.
9. 460-480V, three phase options available for special order in approved locations only.

PREMIUM J SERIES NOZZLES

Available For All HP Sizes. Purchased Separately



**Ready to Upgrade Your Nozzles?
Call Us Today for More Info!**



AQUATICLEAR Clog-Resistant Circulator



IRRIGATION PUMP PROTECTION=GREENER TURF!

- 120V and 208-240V, single phase options
- Unit only, Horizontal Float, and Universal Mount options available
- Universal Mounts include the Simple Swivel bracket.
- Shallow Water Install Kit available.
- Manage from shore with optional human-rated, GFCI-protected control panel
- Can be used to protect irrigation pumps from clogging.
- Filterizes for fresher, cleaner water for your greens.



| HP | VOLT (V) | MODEL | CORD LENGTH | | | | | | | | | |
|---|----------|---------------------|-------------|-------|-------|--------|--------|--------|--------|--------|--------|----------------|
| | | | 25 FT | 50 FT | 75 FT | 100 FT | 150 FT | 200 FT | 250 FT | 300 FT | 400 FT | 500 FT |
| UNIT ONLY PACKAGES - "C" (NO MOUNT) | | | | | | | | | | | | |
| 1/2 | 120 | KAS2400C_ | | | -- | | | | -- | -- | -- | -- |
| 3/4 | 120 | KAS3400C_ | | | -- | | | | -- | -- | -- | -- |
| 3/4 | 208-240 | KAS3400HC_ | -- | | -- | | | | | | | INQUIRE |
| 1 | 120 | KAS4400C_ | -- | | | | | | -- | -- | -- | -- |
| 1 | 208-240 | KAS4400HC_ | -- | | -- | | | | | | | INQUIRE |
| HORIZONTAL FLOAT PACKAGES - "CFM" | | | | | | | | | | | | |
| 1/2 | 120 | KAS2400CFM_ | | | -- | | | | -- | -- | -- | -- |
| 3/4 | 120 | KAS3400CFM_ | | | -- | | | | -- | -- | -- | -- |
| 3/4 | 208-240 | KAS3400HCFM_ | -- | | -- | | | | -- | -- | -- | -- |
| 1 | 120 | KAS4400CFM_ | -- | | | | | | -- | -- | -- | -- |
| 1 | 208-240 | KAS4400HCFM_ | -- | | -- | | | | | | | |
| UNIVERSAL MOUNT PACKAGES - "CDM" (CUSTOMER MUST SUPPLY PIPE) | | | | | | | | | | | | |
| 1/2 | 120 | KAS2400CDM_ | | | -- | | | | -- | -- | -- | -- |
| 3/4 | 120 | KAS3400CDM_ | | | -- | | | | -- | -- | -- | -- |
| 3/4 | 208-240 | KAS3400HCDM_ | -- | | -- | | | | | | | INQUIRE |
| 1 | 120 | KAS4400CDM_ | -- | | | | | | -- | -- | -- | -- |
| 1 | 208-240 | KAS4400HCDM_ | -- | | -- | | | | | | | INQUIRE |

Product Notes:

1. Prices in bold have quick disconnect installed on power cords.
2. Part # is the model combined with cord length (ex. **KAS3400CDM150**).
3. If AquatiClear is installed less than 1.5 ft. below the surface, a Shallow Water Install Kit is recommended.

Kasco® ROBUST-AIRE DIFFUSED AERATION

Restore your water's natural ecosystem by adding mixing and movement with RobustAire™. A shore-mounted compressor pushes air through self-weighted lines to a diffuser at the bottom of the pond, lake, or tank. This induces oxygen transfer and beneficial mixing to prevent weed overgrowth, algae, unpleasant odors, fish kills, and other issues.

- Packages include dual-loop diffuser(s), compressor(s), and compressor cabinet.
- Some models include SureSink Weighted Tubing. Minimal surface disturbance
- Patented AireGuard Cabinet Technology
- Dual-loop diffuser assembly will not clog, includes strain relief, and will land right-side up every time.
- No electricity in the water

SMALL CABINET

(L) 42 - 1/8 in. (W) 20 - 11/16 in. (H) 19 - 5/8 in.

| PART NUMBER | | CABINET | # OF DIFFUSERS | WEIGHTED TUBING | COMPRESSOR |
|---------------------------|--------------|------------|----------------|-----------------------|----------------------|
| 120V | 208V-240V | | | | |
| KASRA1 | KASRH1 | SMALL | 1 | 100 FT. 3/8 IN TUBING | (1) 1/4HP Compressor |
| KASRA1-NC | KASRH1-NC | NO CABINET | 1 | 100 FT. 3/8 IN TUBING | (1) 1/4HP Compressor |
| KASRA2 | KASRH2 | SMALL | 2 | 200 FT. 3/8 IN TUBING | (1) 1/4HP Compressor |
| KASRA2-NC | KASRH2-NC | NO CABINET | 2 | 200 FT. 3/8 IN TUBING | (1) 1/4HP Compressor |
| KASRA3 | KASRH3 | SMALL | 3 | 300 FT. 3/8 IN TUBING | (1) 1/2HP Compressor |
| KASRA3-NC | KASRH3-NC | NO CABINET | 3 | 300 FT. 3/8 IN TUBING | (1) 1/2HP Compressor |
| DOUBLE PISTON (DP) SYSTEM | | | | | |
| KASRA2DP | KASRAH2DP | SMALL | 2 | 200 FT. 3/8 IN TUBING | (1) 1/2HP Compressor |
| KASRA2DP-NC | KASRAH2DP-NC | NO CABINET | 2 | 200 FT. 3/8 IN TUBING | (1) 1/2HP Compressor |



LARGE BASE MOUNT CABINET

POST MOUNT CABINET



- Includes 1-3 dual-loop diffuser assemblies
- 1 compressor, small cabinet, and SureSink Weighted Tubing
- Cabinet can be mounted on the ground or on a vertical structure using the optional mounting bracket
- Ideal for small to mid-size ponds and lakes
- Remote manifold available for installations far from power

MEDIUM CABINET

(L) 25 - 7/8 in. (W) 20 - 11/16 in. (H) 19 - 5/8 in.

| PART NUMBER | | CABINET | # OF DIFFUSERS | COMPRESSOR |
|-------------|-----------|---------|----------------|-----------------------|
| 120V | 208V-240V | | | |
| KASRA4 | KASRH4 | MEDIUM | 4 | (3) 1/2HP Compressors |
| KASRA5 | KASRH5 | MEDIUM | 5 | (2) 1/2HP Compressors |
| KASRA6 | KASRH6 | MEDIUM | 6 | (2) 1/2HP Compressors |



- Includes 4-6 dual-loop diffuser assemblies
- 2 compressors and medium cabinet
- (SureSink Weighted Tubing not included)
- Cabinet is ground-mount only
- Ideal for small to mid-size ponds and lakes
- Remote manifold available for installations far from power

LARGE CABINET

(L) 42 - 1/8 in. (W) 20 - 11/16 in. (H) 19 - 5/8 in.

| PART NUMBER | | CABINET | # OF DIFFUSERS | COMPRESSOR |
|-------------|-----------|---------|----------------|-----------------------|
| 120V | 208V-240V | | | |
| KASRA7 | KASRAH7 | LARGE | 7 | (3) 1/2HP Compressors |
| KASRA8 | KASRAH8 | LARGE | 8 | (3) 1/2HP Compressors |
| KASRA9 | KASRAH9 | LARGE | 9 | (3) 1/2HP Compressors |
| KASRA10 | KASRAH10 | LARGE | 10 | (4) 1/2HP Compressors |
| KASRA11 | KASRAH11 | LARGE | 11 | (4) 1/2HP Compressors |
| KASRA12 | KASRAH12 | LARGE | 12 | (4) 1/2HP Compressors |



- Includes 7-12 dual-loop diffuser assemblies
- 3-4 compressors and large cabinet
- (SureSink Weighted Tubing not included)
- Cabinet is ground-mount only
- Ideal for large industrial or recreational lakes
- Remote manifold available for installations far from power

Pricing is subject to change.

POND PROBIOTICS
Beneficial Bacteria



Kasco's Pond Probiotics are a safe, non-chemical approach to water quality management. Chosen by pond professionals since 1991, Pond Probiotics are used to produce a healthy, balanced eco-system with its highly concentrated, unique blend of naturally occurring bacteria and enzymes that quickly eliminates sludge and odors.

- Just toss in the water, let it go to work
- Apply in water 55 degrees or higher
- Safe for people, pets and fish



| | DESCRIPTION | TREATMENT AREA | REAPPLICATION |
|-----------------|---------------------------------------|-----------------------|---------------|
| KASMZ8 | 8 OZ. WS BAG | 1/2 ACRE-FT. | EVERY 3 WEEKS |
| KASMZ8C | CASE OF 40 X 8 OZ. WS BAGS | UP TO 20 ACRE-FT. | EVERY 3 WEEKS |
| KASMZ25 | 25 LB. BULK BAG IN PAIL, NO WS BAGS | UP TO 20 ACRE-FT. | EVERY 3 WEEKS |
| KASMZMP7 | MUCK PUCKS; 7 LB. PAIL WITH 266 PUCKS | UP TO 10 FT. PER PUCK | EVERY 3 WEEKS |
| KASMZMB5 | MUCK BLOCK; 6 LB. BLOCK | UP TO 6 ACRE-FEET | EVERY 30 DAYS |

AQUATIC WEED REMOVAL RAKES



Floating rake used to remove surface weeds and algae. Weed eradicator used for submerged weeds.

- TLT86036** FLOATING RAKE W/11' HANDLE & 50' THROW ROPE - 36" WIDE.
- TLT87028** WEED ERADICATOR

FAT LASER - HAND HELD UNIT
Green Laser to Deter Geese

- Green laser technology
- Larger dot for easier application
- 12x stronger than other green laser units
- 200 Yard effective radius
- Safe for people & pets



TLTGD-H

GEESE DETERRENENTS

GANDER DISBANDER - FLOATING UNIT
Floats in Lake to Deter Geese



- TLTGD-F** FLOATING W/ STEADY LASER
- TLTGD-FR** FLOATING W/ ROTATING LASER

GANDER DISBANDER - LAND BASED UNIT
Mount on Any Hazard Stake

- Green laser technology comes in two laser styles - rotating beam and 360 degree steady beam
- 12x stronger than other geese deterrents
- 200 Yard effective radius
- Weatherproof enclosure
- Safe for people & pets
- Solar powered
- Designed for use on open level areas
- Land unit comes mounted on 18" stake of any color
- Floating unit comes with a floating ring - just add an anchor



- TLTGD-L** LAND BASED W/ STEADY LASER
- TLTGD-LR** LAND BASED W/ ROTATING LASER



GOPHER HAWK

The Ultimate Gopher & Mole Trap

- Spring loaded trap kills gophers or moles
- Requires no digging for installation or removal
- Yellow indicator tells you when trap has been triggered
- Saves money on labor
- Kit includes one trap, probe & wedge



TLTGH-SET TRAP KIT
TLTGH-TRP TRAP ONLY

BURROW RX

Smoke Out Burrowing Pests



- Direct targeting of rodents within the burrow system.
- No secondary toxicity concerns for scavengers and predators.
- Seldom requires handling of animals after treatment, which reduces the risk of disease and parasite transmittance to humans.
- Highly efficacious.
- Designated as a pest control device by the EPA.

GXCU205 BURROW RX MACHINE
GXOILPTC SMOKE SOLUTION (CASE OF 12 PINTS)

COYOTE REPLICA



- Ultra-sturdy construction with heavy-duty threaded leg posts and locking lugs
- Easily removable legs fit conveniently in the body cavity for easy carry
- Ultra-realistic paint scheme
- Scent pad spike on hind leg
- Includes faux fur tail

TLT5985MS-1

THE GOOSINATOR



The Goosinator is a remote-controlled, space-aged design specifically made to chase geese off of your property. Comes with everything you need to chase off geese including remote, batteries & charger. Visit our website for more information and videos.

- Travels on grass, water, sand or snow
- High speed and easy to maneuver makes it highly effective at harassing geese or coots

GSN001

MACABEE GOPHER TRAPS



The Macabee Gopher Trap is the most effective means of gopher control. It has been copied, but never equaled in quality. Each trap is inspected, set and adjusted to ensure operational perfection. The same expert design used since 1900 shows that Macabee is, indeed, the "Old Reliable."

- Requires no bait
- Safer, more effective than gases or poisons
- Lasts for an unlimited number of kills

TLTMGT

TDR 350 - MOST POPULAR
Moisture, EC & Temp In One Unit

- Displays VWC% (with running average)
- Operates in TDR 300 mode
- Soil measurements in less than a second
- Internal data logging up to 124,000 measurements
- USB port to download data log to a flash drive

TLT6435 TDR350



| FEATURES | TDR150 | TDR250 | TDR350 |
|----------------------------------|----------|--------|-------------|
| MEASURE VOLUMETRIC WATER CONTENT | ✓ | ✓ | ✓ |
| DISPLAYS EC & SURFACE TEMP | ✓ | NO | ✓ |
| INTERCHANGEABLE SOIL PROBES | ✓ | ✓ | ✓ |
| BACKLIT DISPLAY | ✓ | ✓ | ✓ |
| T HANDLE | NO | ✓ | TELESCOPING |
| INFRARED TEMPERATURE SENSOR | OPTIONAL | NO | OPTIONAL |
| GPS & BLUETOOTH | OPTIONAL | NO | ✓ |
| CARRYING CASE | ✓ | NO | ✓ |
| SPEC CONNECT CAPABLE | ✓ | NO | ✓ |

TDR 250 ECONOMY
Perfect for the Crew

TLT6250 TDR250



- Improved measurement of Soil Moisture (Volumetric Water Content)
- Measures EC (Electrical Conductivity)
- Measures Turf Surface Temperature
- Improved Backlit Display
- Integrated Bluetooth
- Internal GPS

FIELDSCOUT TDR 150
Handheld Precision

TLT6445 TDR 150



- Improved measurement of Soil Moisture (Volumetric Water Content)
- Measures EC (Electrical Conductivity)
- Measures Turf Surface Temperature
- Improved Backlit Display
- Integrated Bluetooth
- Internal GPS

TDR RODS

Rods Sold in Sets of 2

- TLT6428FS4 1.5" RODS
- TLT6429FS4 3" RODS
- TLT6431FS4 4.8" RODS
- TLT6432FS4 8" RODS



FIELDSCOUT TDR ROD SPACER

Measures 0.5" or 1.0" shallow depths when used with 1.5" rods.

- Easy to use: attach and detach from Spectrum TDR 350/250/150 .
- Push the spacer onto the sensor block such that the desired length of rod is exposed.



TLT6435SP

FIELDSCOUT APP

App Subscription Through Par West!

FieldScout TDR meters can be used with the FieldScout Mobile App!

- Handsfree data collection
- The FieldScout Basic app allows you to take measurements in grid format
- Purchase a SpecConnect Pro subscription to take freeform measurements and see geo-referenced data points overlaid on your property
- Color coded data points to represent a scale of moisture, EC, surface temperature or turf firmness
- Map sprinkler heads, holes, pin locations and more
- Automatic wireless upload to SpecConnect for further analysis from your personal web portal



TDR in FREEFORM mode in a field of row crops. Pin colors can be changed to suit your preference.

TDR soil moisture data plots on a golf course using both the FREEFORM and GRID mode.

Views data in SpecConnect for more detailed informaton and reportng.

SPECCONNECT FIELDSCOUT SUBSCRIPTION PLANS

- TLT3035A 1 YEAR SUSCRPTION - 1-3 DEVICES
- TLT3035B 1 YEAR SUSCRPTION - 4-7 DEVICES
- TLT3035C 1 YEAR SUSCRPTION- 8+ DEVICES



SPOTON® POCKET SOIL MOISTURE METER



TLT41430

FIELDSCOUT Direct Soil EC Meter



- TLT2266FS EC METER W/ 8" PROBE AND CASE
- TLT2266FSTP EC METER W/ 24" T PROBE
- TLT2266PRB REPLACEMENT 8" PROBE
- TLT2225FSTP REPLACEMENT 24" PROBE
- TLT2251 CONDUCTIVITY STANDARD

AMES INSTRUMENTS HAND HELD INFRARED THERMOMETER

12:1 Infrared Laser



- Excellent readability indoor and outdoors
- -50°C~550°C (-58°F~1022°F) Temp Range
- Backlit display
- High visibility laser targeting
- Designed for industrial, automotive, electrical and HVAC use ONLY.

TLT2956

SPOTON® TURF MOISTURE METER PRO



- Quick and accurate soil moisture, EC (salinity), and temperature readings in a compact and durable design.
- Rubber mounted rods resist bending in dry or rocky soil
- Measures soil moisture, salinity (EC), and soil surface temperature (°F or °C)
- Includes both 2.375" and 1.5" probe rods
- Companion SpotView™ mobile app

TLT42550

SPOTON® TURF MOISTURE METER



- Quick and accurate soil moisture, EC (salinity), and temperature readings in a compact and durable design.
- Continuous readings for quick moisture testing (no button pressing required)
- Measures soil moisture, salinity (EC), and soil surface temperature (°F or °C)
- Includes both 2.4" and 1.5" probe rods

TLT39240

SPOTON® TURF MOISTURE METER REPLACEMENT RODS 1.5' & 2.4" Options



- Rubber mounted rods resist bending in dry or rocky soil
- Set of replacement rods comes in two replacement sizes

TLT40310 1.5" RODS

TLT40470 2.4" RODS

SPOTON® DIGITAL SOIL COMPACTION METER



- 30in (76cm)
- 0 to 825 PSI (0 to 5690 kPa)
- Meets ASABE S313.3 Soil Compaction Standard
- Automatically displays maximum compaction value when probe is extracted from the soil
- Stainless steel shaft with depth marking every 4in (10cm)
- Internal GPS

TLT29360

MACROSCOPE

Portable Monocular Microscopes



- 20X is a fixed magnification monocular unit that provides 20X magnification and is ideal for insect identification in turfgrass environments. 20X offers a 5/16 (0.8 mm) field of view.
- 40X is ideal for disease diagnosis on turfgrass plants. 40X offers a 3/16 inch (0.4 mm) field of view.

TLTMACR20-2-C 20X MAGNIFICATION

TLTMACR40-2-C 40X MAGNIFICATION

SOILSTIK PH METER Checks PH In Soil Or Water



TLT2105 SOILSTIK PH METER

TLT2106 REPLACEMENT SENSOR

SPRINKLER RAIN GAUGE COMBO



- 2-piece set
- Can use on fence, ground spike, or wall mount
 - Can gauge up to 5 feet

IRRRG

SPOTON® QUANTUM PAR LIGHT METER



TLT35650

SPOTON® SC-5 UNIVERSAL FLOW METER



TLT38580

TRUE FIRM FIRMNESS METER With Bluetooth



Based on technology developed by the USGA, the fieldscout trufirm offers a quick, easy, and affordable method to measure the firmness of turf and bunker sands.

TLT6490S

TURF SPY Stress Detection Glasses



Based on technology from NASA, turf spy glasses will help you see stress 2-10 days before it appears to the naked eye.

IRNRG655-01

18" EASY REACH SOIL SAMPLER

With Ball Mark Repair Tool

- 18" length and pulls a 7/16" core – perfect for greens
- Ergonomic and comfortable handle contains a flip out ball mark tool that allows you to fix the hole from pulling the plug

IRRTSP-SS18



PROFILE SAMPLER

- Quickly pull a clean root zone sample.
- Check roots in fine turf areas.
- Steel construction, zinc-plated, case-hardened blade.
- 8"H x 4"W x 3/4"D samples.



STD29400



ACCUFORM SOIL PROFILE SAMPLER

- Hinge design for easy profile viewing.
- Tapered design prevents blades from separating
- Our Profile Sampler gives you an undisturbed soil profile 6 in. (15 cm) deep, 3 in. (8 cm) wide and 1/2 in. (1 cm) thick
- Hinge allows you to easily view the root zone and thatch clearly, with no bolts or screws to get in the way
- The innovative design not only keeps the blades from separating when inserted into the turf, but also makes it easier to replace the sample after viewing
- 25-1/2 in. (65 cm) Tall

PAR1130



COMPACT SOIL PROBE



ROUND SOIL PROFILE SAMPLER

Adjustable depth gauge allows soil sampler to double as 2" plunger repair.

- Designed for use on well watered golf greens
- Open side barrel for easy inspection of soil structure
- Tee handle and hand grips for ease of use
- Hardened steel blade

IRRTSP-SS



TURF DOCTOR

- Invisible sod replacement.
- Finish patch areas without leaving holes or gaps (i.e. irrigation repair).
- Razor-sharp blades (4) secure 9" (23 cm) square-cut, wedge-shaped sod blocks that fit and butt perfectly.

STD 29200



Designed for small core soil samples, fast simple and accurate.

- Triple window tine for quick and easy viewing of soil strata near the turf surface
- Lightweight stainless steel construction
- Plug size: 3/4" x 9 3/4"
- Removable "T" handle with convenient metal storage container

IRRTSP-HS



SOIL PROBES

- All of our soil probes are made of high quality stainless steel
- 3 sizes to choose from for any application

| PART NUMBER | PLUG DIAMETER | LENGTH | |
|---------------|---------------|----------|----|
| 1. IRRTSP-12 | 1 IN | 12X12 IN | NO |
| 2. TLTSP-716 | 7/16 IN | 18 IN | NO |
| 3. TLTSP-127 | 1/2 IN | 7 IN | NO |
| 4. TLTSP-7820 | 3/4 IN | 20 IN | NO |
| 5. TLT77636 | 7/8 IN | 40 IN. | NO |



LARGE ROUND TURF REPAIR
Soil Profile Sampler



Foot operated and spring loaded ejector for quick turf plug removal. Ideal for extracting disease samples and repairing damaged turf.

- Variable depth adjustment 1" - 4"
- Available in 4" & 6" round models
- 4" models ideal for extracting disease samples and turf repair
- 6" model great for damaged turf repair
- Thin blade is heat treated and zinc plated for clean cut

IRRTRP-4 4" WIDE
IRRTRP-6 6" WIDE

SMALL ROUND TURF REPAIR
Soil Profile Sampler



Hand push operated turf plunger/sampler collects plugs in tube stem. Ideal for soil sampling and divot repair on golf greens.

- Variable depth adjustment 1/4" - 4"
- Each plug is pushed up into tube as next plug is taken
- Plunger is zinc plated body and heat treated steel blade
- Solid steel construction for long life

IRRTRP-2 2" WIDE

TRU-DEPTH SAND PROBE
Check Depth of Bunkers



The Tru-Depth Sand Probe provides a quick way to check the depth of bunkers. Simply insert the probe into the sand and quickly read the true compacted sand depth.

- Easily readable ruler
- Measuring depth 0 - 7"
- Aluminum and stainless steel

ACUTRU-07 3" WIDE



GREENS KEEPER LEVEL LAWN

- Available in 30", 36" and 40" models
- Super heavy duty high impact resistant 72" fiberglass handle

IRRTLLG-30K 30" HEAD
IRRTLLG-36K 36" HEAD
IRRTLLC-40K 40" HEAD



PAR AIDE ACCULEVEL

Perfect for soil preparation projects of all kinds – spreading, smoothing and breaking up soil.

- 34" x 10" plated steel head
- 72" lightweight, sturdy aluminum handle – better than wooden handles!

PAR13265 34" WIDE



LEVELLAWN PRO

- The head comes in two sizes (30 or 36) for different sized projects
- The wood handle is 72 (183 cm) long.
- Now made with 2-piece wood handle

STD29310 30" HEAD W/SPLIT HANDLE
STD29320 36" HEAD W/SPLIT HANDLE



LEVEL LAWN PULL MASTER

- a top choice for seeding larger areas or overseeding greens
- Multiple rope hole attachments provided to control ground pressure options
- Heavy enough to move large areas of material
- Nylon rope and special grip handle included
- 72-inch head

IRRTLLP-72 72" WIDE

VIPER HAND AERIFIER



- Comes with 10 Viper Quad Tines
- Powder coated. Shipped with 1/8" MiniQuad or alternative 3/8" mount tine
- Only Hand Aerifier on the market with interchangeable and replaceable tines
- Ideal for "Hot Spots" at the end of cart paths, around ponds and in narrow spaces

CT14-VHT HAND AERIFIER WITH TINES

SPOT AERIFIER



- Three 1/2" Side-Eject Hollow Tines
- Formed steel flat foot bar base for extra leverage with "T" hand and hand grips for ease of use.

IRRT3TA SPOT AERIFIER 0

WETTING FORK



- Comes with (3) stainless steel perforated tines.
- Complete with valve and hose fittings for 3/4" and 1" hose.

TLTW2 WETTING FORK

TURFJECTOR



- Features four injector tines that can be inserted up to 2 inches deep.
- Comes with a ball valve to control water flow and connects to a 3/4" hose.



PAR525570 TURFJECTOR

PAR525571 REPLACEMENT TINE



SOD STRIPPER

W/Replacement Blade Kit



- Cut a strip of sod for any turf repair
- The ultimate tool for repairing hydraulic leaks
- Solid steel construction with zinc plating
- Blade width available in 2 in., 3 in., 5 in. and 7 in.
- Depth of cut adjustable between 5/8 in. and 1 in.
- 7 in. X 2 in. deep cut blade can be used in conjunction with 7 in. X 2 in. hex-plugger
- Easily strips out damaged area as well as replacement turf from nursery green
- Precut strips on nursery green and then use hex-plugger to cut replacement plugs
- Saves time by eliminating trowel cutting of individual plugs
- Ensures consistent depth of hex plug



- PAR510220** SOD STRIPPER COMBO WITH 2", 3", 5", & 7" BLADES
- PAR510221** SOD STRIPPER COMBO W/ 4 BLADES + 7" X 2" DEEP CUT BLADE
- PAR510212** SOD STRIPPER W/ 2" BLADE
- PAR510213** SOD STRIPPER W/ 3" BLADE
- PAR510215** SOD STRIPPER W/ 5" BLADE
- PAR510217** SOD STRIPPER W/ 7" BLADE
- PAR510218** SOD STRIPPER W/ 7" X 2" DEEP CUT BLADE
- PAR510222** 2 INCH BLADE
- PAR510223** 3 INCH BLADE
- PAR510225** 5 INCH BLADE
- PAR510227** 7 INCH BLADE
- PAR510228** 7"X2" DEEP CUT BLADE

PAR AIDE HEX PLUGGER



5"W X2"D 7"W X2"D 7"W X3"D

- PAR502105** 5" WIDE X 2" DEEP
- AR502107** 7" WIDE X 2" DEEP
- PAR502108** 7" WIDE X 3" DEEP
- PAR670651** HANDLE FOR HEX PLUGGER

DEEP HEXAGON DIVOT TURF PLUGGER

4" x 8" X 2" Deep



TLTPUG-HEX-4X8

QUICK SEED" II

13" Wide



PAR543564

ACCUFORM STAR SPIKER

12" Wide



PAR13256

SPOT OVERSEEDER & SPIKER



PAR540560

PLUG STACKER

Holds 12 Plugs At A Time



- PAR1095** TURF PLUGGER
- PAR1094** BALL MARK PLUGGER

ACCUFORM GREENS EDGER



- PAR13260** GREENS EDGER
- PAR13261** REPLACEMENT BLADES (3)

ACCUFORM FIXED SPIKER



PAR543600

TRI-TOOL



- Repairing ball marks with the stainless-steel coring tine and spike
- Removing weeds
- Coring soil samples
- Leveling cup holes
- Rolling out cup holes and ball marks

PAR1039

EXTENDED RANGE STAINLESS FLAT FAN SPRAY TIPS

The Industry Favorite



80 DEGREE TIPS

110 DEGREE TIPS

| | | | |
|--------------------|--------|---------------------|--------|
| TJXR8001VS | ORANGE | TJXR11001VS | ORANGE |
| TJXR80015VS | GREEN | TJXR110015VS | GREEN |
| TJXR8002VS | YELLOW | TJXR11002VS | YELLOW |
| TJXR8003VS | BLUE | TJXR11003VS | BLUE |
| TJXR8004VS | RED | TJXR11004VS | RED |
| TJXR8005VS | BROWN | TJXR11005VS | BROWN |
| TJXR8006VS | GRAY | TJXR11006VS | GRAY |

- Excellent spray distribution over a wide range of pressures—15–60 PSI
- Ideal for rigs equipped with sprayer controllers.
- Reduces drift at lower pressures, better coverage at higher pressures



| | |
|-----------------------|-----------|
| CONTACT HERBICIDES | EXCELLENT |
| SYSTEMIC HERBICIDES | GOOD |
| CONTACT FUNGICIDES | EXCELLENT |
| SYSTEMIC FUNGICIDES | GOOD |
| CONTACT INSECTICIDES | EXCELLENT |
| SYSTEMIC INSECTICIDES | GOOD |
| DRIFT MANAGEMENT | GOOD |

EXTENDED RANGE STAINLESS FLAT FAN SPRAY TIPS

Stainless Tip Mounted Complete With Cap



80 DEGREE TIPS

110 DEGREE TIPS

| | | | |
|---------------------|--------|----------------------|-------------|
| TJXRC80015VS | GREEN | TJXRC11002VS | YELLOW |
| TJXRC8002VS | YELLOW | TJXRC110025VS | PURPLE |
| TJXRC8003VS | BLUE | TJXRC11003VS | BLUE |
| TJXRC8004VS | RED | TJXRC11004VS | RED |
| TJXRC8005VS | BROWN | TJXRC11005VS | BROWN |
| TJXRC8006VS | GRAY | TJXRC11006VP | GRAY |
| TJXRC8008VS | WHITE | TJXRC11008VP | WHITE |
| | | TJXRC11010 | LIGHT BLUE |
| | | TJXRC11015 | LIGHT GREEN |
| | | TJXRC11020 | BLACK |

AIR INDUCTION FLAT SPRAY TIPS

| | |
|-----------------------|-----------|
| CONTACT HERBICIDES | GOOD |
| SYSTEMIC HERBICIDES | EXCELLENT |
| CONTACT FUNGICIDES | GOOD |
| SYSTEMIC FUNGICIDES | EXCELLENT |
| CONTACT INSECTICIDES | GOOD |
| SYSTEMIC INSECTICIDES | EXCELLENT |
| DRIFT MANAGEMENT | EXCELLENT |



- Larger droplets for less drift.
- Available in eight capacities with a pressure rating of 30–115 PSI
- Depending on the chemical produces
- Large air-filled Drops through the use of a Venturi air aspirator.



80 DEGREE TIPS

110 DEGREE TIPS

| | | | |
|--------------------|--------|---------------------|--------|
| TJAI8002VS | YELLOW | TJAI110015VS | GREEN |
| TJAI80025VS | PURPLE | TJAI11002VS | YELLOW |
| TJAI8003VS | BLUE | TJAI110025VS | PURPLE |
| TJAI8004VS | RED | TJAI11003VS | BLUE |
| TJAI8005VS | BROWN | TJAI11004VS | RED |
| TJAI8006VS | GRAY | TJAI11005VS | BROWN |
| | | TJAI11006VS | GRAY |
| | | TJAI11008VS | WHITE |

AIR INDUCTION FLAT SPRAY TIPS

Stainless Tip Mounted Complete With Cap



110 DEGREE TIPS

- All tip/cap combinations include Seat Gasket



| | |
|----------------------|-------------|
| TJAIC110015VS | GREEN |
| TJAIC11002VS | YELLOW |
| TJAIC110025VS | PURPLE |
| TJAIC11003VS | BLUE |
| TJAIC11004VS | RED |
| TJAIC11005VS | BROWN |
| TJAIC11006VS | GRAY |
| TJAIC11008VS | WHITE |
| TJAIC11010VS | LIGHT BLUE |
| TJAIC11015VS | LIGHT GREEN |

TURBO TEEJET SPRAY TIPS

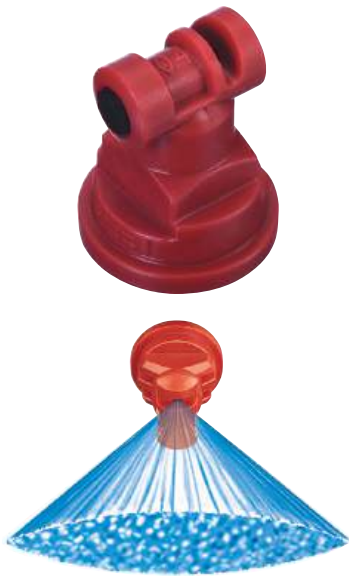

- Tapered edge wide angle flat spray pattern for uniform coverage in broadcast spraying.
- Large, rounded internal passage to minimize clogging.
- Excellent resistance to corrosive solutions.
- Larger droplets for less drift— 15–90 PSI

| | |
|-----------------------|-----------|
| CONTACT HERBICIDES | VERY GOOD |
| SYSTEMIC HERBICIDES | VERY GOOD |
| CONTACT FUNGICIDES | VERY GOOD |
| SYSTEMIC FUNGICIDES | VERY GOOD |
| CONTACT INSECTICIDES | VERY GOOD |
| SYSTEMIC INSECTICIDES | VERY GOOD |

TURBO TWINJET TIPS

| | |
|--------------|--------|
| TJTT11001VP | ORANGE |
| TJTT110015VP | GREEN |
| TJTT11002VP | YELLOW |
| TJTT110025VP | PURPLE |
| TJTT11003VP | BLUE |
| TJTT11004VP | RED |
| TJTT11005VP | BROWN |
| TJTT11006VP | GRAY |
| TJTT11008VP | WHITE |

AIR INDUCTION TURBO TWINJET DUAL SPRAY TIPS

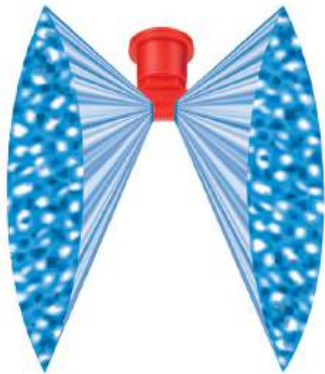

- Air induction with dual 110° flat fan patterns
- 60° between leading and trailing spray patterns
- Good coverage with increased canopy penetration and best drift control
- Excellent drift control with coarse to very coarse droplets
- Pressure ranges from 20–90 PSI



| | |
|-----------------------|-----------|
| CONTACT HERBICIDES | GOOD |
| SYSTEMIC HERBICIDES | EXCELLENT |
| CONTACT FUNGICIDES | GOOD |
| SYSTEMIC FUNGICIDES | EXCELLENT |
| CONTACT INSECTICIDES | GOOD |
| SYSTEMIC INSECTICIDES | EXCELLENT |

AI TURBO TWINJET TIPS

| | |
|-------------------|--------|
| TJAITTJ6011002VP | YELLOW |
| TJAITTJ60110025VP | PURPLE |
| TJAITTJ6011003VP | BLUE |
| TJAITTJ6011004VP | RED |
| TJAITTJ6011005VP | BROWN |
| TJAITTJ6011006VP | GRAY |

TURBO TWINJET FLAT FAN DUAL SPRAY TIPS

- Dual outlet design produces two 110° flat fan spray patterns using the patented technology from the Turbo TeeJet® nozzle.
- The angle between each spray pattern is 60° forward and back.
- Best suited for broadcast spraying where superior leaf coverage and canopy penetration is important.
- Droplet size range is slightly larger than the same capacity Turbo TeeJet nozzle providing drift-reducing properties with increased canopy coverage and penetration.
- Ideal for use with automatic sprayer controllers.



| | |
|-----------------------|-----------|
| CONTACT HERBICIDES | EXCELLENT |
| SYSTEMIC HERBICIDES | EXCELLENT |
| CONTACT FUNGICIDES | EXCELLENT |
| SYSTEMIC FUNGICIDES | EXCELLENT |
| CONTACT INSECTICIDES | EXCELLENT |
| SYSTEMIC INSECTICIDES | EXCELLENT |
| DRIFT MANAGEMENT | VERY GOOD |

TURBO TWINJET TIPS

| | |
|---------------|--------|
| TJTTJ6011002 | YELLOW |
| TJTTJ60110025 | PURPLE |
| TJTTJ6011003 | BLUE |
| TJTTJ6011004 | RED |
| TJTTJ6011005 | BROWN |
| TJTTJ6011006 | GRAY |

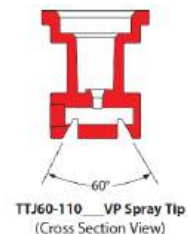

Pricing is subject to change.



QUICK TEEJET CAPS

The Quick TeeJet caps are designed with grooves that fit locating lugs on the nozzle body. Caps are made of nylon and are available for use with all TeeJet spray tips.

Quick Jet Caps Only - Fits Nozzles Below

- XR Flat Fan Tips - 01-08 Sizes
- Turbo TeeJet
- Turbo twinJet

| | |
|-----------------|--------|
| TJCP25610-1-NYR | BLACK |
| TJCP25610-2-NYR | WHITE |
| TJCP25610-3-NYR | RED |
| TJCP25610-4-NYR | BLUE |
| TJCP25610-5-NYR | GREEN |
| TJCP25610-6-NYR | YELLOW |
| TJCP25610-7-NYR | BROWN |



TEEJET DIAPHRAGMS



TJCP21953-EPR RUBBER



TJCP21953-VI VITON



NOZZLE STRAINER

TJ8079-PP-50 50 MESH

TJ8079-PP-100 100 MESH



SEAT GASKET

TJCP19438-EPR

Quick Jet Caps Only - Fits Nozzles Below

- Air Induction
- Turbo Teejet Air Induction
- Turbo Twinjet Air Induction

| | |
|-----------------|--------|
| TJCP25597-1-NYR | BLACK |
| TJCP25597-2-NYR | WHITE |
| TJCP25597-3-NYR | RED |
| TJCP25597-4-NYR | BLUE |
| TJCP25597-5-NYR | GREEN |
| TJCP25597-6-NYR | YELLOW |
| TJCP25597-7-NYR | BROWN |



PRESSURE GAUGE



IRRPG100L-4 100 PSI GAUGE

- 1/4" MPT connection
- 4" display
- Stainless Steel case w/ Aluminum gauge

BOOMJET BOOMLESS NOZZLES

- Used for spraying areas not easily accessed with a boom
- Sprayer or for bulk fertilizer applications
- Combine two off-center tips and three VeeJet® nozzles to produce a wide swath flat spray
- The 5880 features a 1/4" gauge port and is supplied with one additional 1/4" NPT pipe plug and one blank tip for spraying to one side only
- The 5430 utilizes a swivel design which can be adjusted to modify the spray pattern width
- Both models feature 3/4" NPT female inlet threads



SPRAY RATES

| PSI | GPM | WIDTH | GPA @ | GPA @ |
|-----|------|-------|-------|-------|
| | | | 4 MPH | 5 MPH |
| 20 | 12.0 | 56 | 26 | 21 |
| 30 | 14.7 | 60 | 34 | 24 |
| 40 | 17.0 | 63 | 33 | 27 |

| PART NUMBER | TYPE |
|-------------------|----------------|
| TJ5430-3/4-2TOC40 | SWIVEL |
| TJ5880-3/4-2TOC40 | FIXED POSITION |

TEEJET QUICKJET OUTLET BOOM ADAPTERS

WET BOOM ADAPTERS



- Available with either 3, 4 or 5 spray positions for easy change of spray tips or quick boom flushing.
- Positive shutoff between each spray position.
- Automatic spray alignment using flat fan spray tips.
- Available in 1/2 in, 3/4 in or 1 in single or double hose shanks.
- Includes ChemSaver® diaphragm check valve for drip-free shutoff.
- Standard diaphragm opens at 10 PSI
- Durable design mounts body high on boom structure for maximum protection.

| | | |
|------------------|------------|----------|
| TJQJ363C-1/2-NYB | 1/2" CLAMP | 3 OUTLET |
| TJQJ363C-3/4-NYB | 3/4" CLAMP | 3 OUTLET |
| TJQJ363C-1-NYB | 1" CLAMP | 3 OUTLET |
| TJQJ364C-1/2-NYB | 1/2" CLAMP | 4 OUTLET |
| TJQJ364C-3/4-NYB | 3/4" CLAMP | 4 OUTLET |
| TJQJ364C-1-NYB | 1" CLAMP | 4 OUTLET |
| TJQJ365C-1/2-NYB | 1/2" CLAMP | 5 OUTLET |
| TJQJ365C-3/4-NYB | 3/4" CLAMP | 5 OUTLET |
| TJQJ365C-1-NYB | 1" CLAMP | 5 OUTLET |

- 3 outlet adapter lets you easily switch nozzles for different applications
- Clamps on to boom pipe

SINGLE NOZZLE BODIES FOR WET BOOMS



- Can be mounted to 20 mm, 25 mm, 1/2 IN, 3/4 IN or 1 IN pipe or equivalent size tubing.
- Features ChemSaver drip-free shutoff. Requires 10 PSI at the nozzle to open check valve

| | |
|--------------------|------------|
| TJQJ17560A-1/2-NYB | 1/2" CLAMP |
| TJQJ17560A-3/4-NYB | 3/4" CLAMP |
| TJQJ17560A-1-NYB | 1" CLAMP |

SINGLE NOZZLE BODIES FOR DRY BOOMS

- Available with single, double or triple hose shanks for 3/8 in, 1/2 in and 3/4 in I.D. hose.
- Drip-free shutoff with TeeJet ChemSaver Opens at 10 PSI Standard



| | | |
|---------------------|------|--------|
| TJ19349-211-406-NYB | 1/2" | 1 BARB |
| TJ19349-211-540-NYB | 3/4" | 1 BARB |
| TJ19349-211-785-NYB | 1" | 1 BARB |
| TJ19350-212-406-NYB | 1/2" | 2 BARB |
| TJ19350-212-540-NYB | 3/4" | 2 BARB |
| TJ19350-212-785-NYB | 1" | 2 BARB |
| TJ19351-213-406-NYB | 1/2" | 3 BARB |
| TJ19351-213-540-NYB | 3/4" | 3 BARB |
| TJ19351-213-785-NYB | 1" | 3 BARB |

DRY BOOM ADAPTERS

- Available with either 3, 4 or 5 spray positions for easy change of spray tips or quick boom flushing.
- Positive shutoff between each spray position.
- Automatic spray alignment using flat fan spray tips.
- Maximum operating pressure of 300 PSI
- Available in 1/2 in, 3/4 in or 1 in single or double hose shanks

| PART NUMBER | SIZE | BARBS | # OF OUTLETS |
|---------------------|------|--------|--------------|
| TJQJ363C-500-1-NYB | 1/2" | 1 BARB | 3 |
| TJQJ363C-750-1-NYB | 3/4" | 1 BARB | 3 |
| TJQJ363C-1000-1-NYB | 1" | 1 BARB | 3 |
| TJQJ363C-500-2-NYB | 1/2" | 2 BARB | 3 |
| TJQJ363C-750-2-NYB | 3/4" | 2 BARB | 3 |
| TJQJ363C-1000-2-NYB | 1" | 2 BARB | 3 |
| TJQJ364C-500-1-NYB | 1/2" | 1 BARB | 4 |
| TJQJ364C-750-1-NYB | 3/4" | 1 BARB | 4 |
| TJQJ364C-1000-1-NYB | 1" | 1 BARB | 4 |
| TJQJ364C-500-2-NYB | 1/2" | 2 BARB | 4 |
| TJQJ364C-750-2-NYB | 3/4" | 2 BARB | 4 |
| TJQJ364C-1000-2-NYB | 1" | 2 BARB | 4 |



Pricing is subject to change.

DRAINAGE

ADS WYE FITTING



IRRADS322AA 3 INCH
IRRADS422AA 4 INCH

ADS TEE



IRRADS321AA 3 INCH
IRRADS421AA 4 INCH

ADS SNAP ON CAP



IRRADS332AA 3 INCH
IRRADS432AA 4 INCH

ADS SNAP ON COUPLING



IRRADS312AA 3 INCH
IRRADS412AA 4 INCH

NDS SQUARE CATCH BASIN



IRRNDS900 9" x 9" 2 OUTLET
IRRNDS900-4 9" x 9" 4 OUTLET
IRRNDS1200 12" x 12" 2 OUTLET
IRRNDS1200-4 12" x 12" 4 OUTLET

NDS DRAIN GRATE



IRRNDS990 9" x 9" GREEN
IRRNDS911 9" x 9" BLACK
IRRNDS1212 12" x 12" GREEN
IRRNDS1211 12" x 12" BLACK

**NDS CATCH BASIN
OUTLET ADAPTER & PLUG**



IRRNDS1243 3" OR 4" OUTLET
TO PIPE ADAPTER
IRRNDS1206 OUTLET PLUG



Ideal for 4"-6"
drains and catch basins



Perfect for sleeving
under sidewalks

DRAIN BLASTER

High Pressure Drain Cleaning

This unique hose-end, high pressure nozzle guides itself in cleaning out drains, to remove debris with ease. Special feature includes a wire attachment connector for using wire locator to determine drain route.

- Front jet cuts through blockage
- Rear jets propel nozzle upline
- Two stage flushing action
- Minimum water pressure: 70 psi
- Heat treated grade 303 Stainless Steel for long life
- Great for sleeving under sidewalks or cart paths

IRRDN-75 3/4"

IRRDN-10 1"



4 GALLON BACKPACK SPRAYER

SP Pro Spray Systems



TLTSP100 4 GAL SPRAYER

HAND-HELD SPRAYER

SP Pro Spray Systems



TLTYT10 1 GALLON

TLTBL20 2 GALLON

4 GALLON ELECTRIC SPRAYER

Cordless - No Pumping!



TLTSP105E

12 VOLT SPRAYER

Shurflo Pump, 10' Hose & Wand

- 12 volt connection hooks directly to the battery on any utility vehicle
- Comes with 10 foot spray hose and wand with adjustable nozzle
- 16, 26 or 46 Gallon Poly Tank
- ShurFlo 12 Volt, 1.8 GPM, 60 PSI Diaphragm Pump
- Pressure Demand Switch



PBMES-16 16 GALLON SPRAYER

PBMES-26 26 GALLON SPRAYER

PBMES-44 46 GALLON SPRAYER

ROLLING SPRAY GUN

- Paint or pigment dormant turf with the ultimate precision
- Apply herbicides precisely
- No drift or overspray
- No need to walk in sprayed area
- Nozzles on either side of wheel can be turned on or off
- Quick connect fittings make it easy to connect to sprayer



TLTRSG ROLLING SPRAY GUN

TLTTP8004 REPLACEMENT SPRAY GUN NOZZLE

GREEN SPEED WALKING BOOM SPRAYER

- Safe & accurate chemical application
- 5' wide w/ 5 nozzles at 12" spacing
- High-quality spray gun with trigger lock and pressure gauge
- Well-balanced design with pneumatic rubber tires for smooth maneuverability.



TLTWB5

ACCUSPEED WALKING BOOM SPRAYER

- Digital speedometer and top-mounted pressure gauge help optimize walking/application speed
- High-quality spray gun with trigger lock and 1/2" couplers for easy operation and quick disconnect
- Standard, 80 stainless-steel boom features eight diaphragm-check nozzle bodies for drip-free operation
- Well-balanced design with semi-pneumatic rubber tires for smooth maneuverability



BROI-1575D

SPRAY HAWK WALK-BEHIND FOLDING BOOM SPRAYER



Transform your turf maintenance routine with the Spray Hawk Walk-Behind Folding Boom Sprayer, the ultimate solution for precision liquid application. Designed for greens and areas where bulky sprayers simply can't go, this sprayer delivers an impressive 80 inches of coverage while offering unparalleled maneuverability.

- Aluminum Frame (unit weighs 29lbs/13kg)
- 2 x Ball Bearings in each wheel
- Hoses – JVT Rubber 3/4" ID (main) / 1/2" ID (boom)
- 11.8"/30cm Diameter Semi-Pneumatic Tires
- Adjustable Rear Wheel for spray height setting
- 8 x TeeJet Quickjet Nozzles (10" Spacing)
- XR8004VS Nozzle Tips (80° spray angle / 0.4 GPM)
- Horizontal Spacing – 10 in / 25.4 cm
- Vertical Height – Adjustable up to 16 in / 40.6 cm
- Spraying Width – 80 in / 203 cm
- Output Shut-Off Valves – 2: one for each boom section.



SHCD30E-200

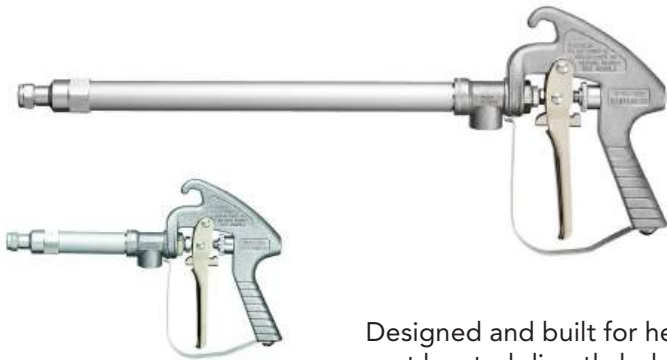

TEEJET GUNJET HAND HELD SPRAY GUNS

Designed and built for heavy duty service. Stem extends through extension to valve seat located directly behind orifice disc for drip-free shutoff and instant operating response. Convenient trigger-lock for continuous spraying.

- Trigger handle control: all models have 1/2" NPT inlet
- Choose orifice size that best matches flow needed
- All orifices spray a 10 foot horizontal swath - distance of throw listed in table below

| PART NUMBER | LENGTH | ORIFICE SIZE | FLOW RATE |
|---------------|--------|--------------|-----------------|
| TJAA43LA-AL6 | 13" | 6 | 1.2 GPM / 44 FT |
| TJAAB43LA-AL8 | 13" | 8 | 2.0 GPM / 45 FT |
| TJAAB43L-AL4 | 22" | 4 | 0.6 GPM / 36 ft |
| TJAAB43L-AL6 | 22" | 6 | 1.2 GPM / 44 FT |
| TJAAB43L-AL8 | 22" | 8 | 2.0 GPM / 45 FT |

SPOTON® SPRAYER CALIBRATOR MODEL SC-2



- Provides quick and accurate flow rate checking of individual sprayer nozzles. This model is best for flow rates below 2.25 GPM typical of herbicide and insecticide application.

TLT38790

BRASS DRUM FAUCET



- Threads into drum or tote for easy and quick dispersal of product

SHPDV-B

IN-LINE WATER METER



- 1 inch pipe thread - connect to water supply to measure exactly how much water you are putting into spray tank
- Chemical and fertilizer resistant

IRRFM1

ALUMINUM DRUM WRENCH



SHPDW

SPRAYER HOSE

3/8" Braided Hose - 150 PSI



TLTHOSE38

BRASS TIP WAND



- Brass tip
- Fits most models of sprayers
- For use with pump or electric sprayers
- 3/8 inch barb fitting

TLTWAND

12 VOLT SHURFLO PUMP

With Toggle Switch



- Replacement pump fits most portable sprayers
- 12 Volt hooks up to utility vehicle battery
- Comes with on/off toggle switch
- Wire harness is 10 feet long with connection plug on one end and alligator clips on other end with in-line on/off switch

TLTSHU12V

1.8 GPM

TLTSHU3GPM

3 GPM

TLTSHU-WH

WIRE HARNESS

GANDY CALIBRATION PANS

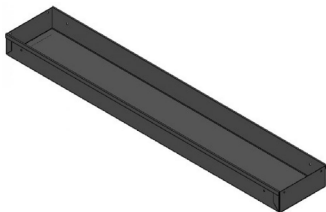

- Calibration pans hang below the spreader to catch and accurately weigh the material coming out. This ensures the most accurate calibration.
- Wire, chain or string to hang to spreader not included with pan.

GAN28248584 24" WIDTH

GAN28368584 36" WIDTH

GANDY DROP SPREADER

Variable Rate Drop Spreaders

- The most reliable and industry favorite drop spreader
- 13" pneumatic wheels
- Adjustable variable-rate stainless steel bottom/slide & steel tri-bar rotor for internal agitation
- Used to apply a variety of seeds, granular chemicals, fungicides, fumigants and fertilizers.



GAN24H13 24" WIDTH

GAN36H13 36" WIDTH

GAN42H16 42" WIDTH



ANDERSONS SR2000 PRO FERTILIZER SPREADER
Stainless Steel Frame

- Optimized handle height reduces operator strain and promotes a level spread pattern during operation.
- Larger-diameter stainless steel tubing at the handlebar improves grip comfort.
- Redesigned frame increases stability, virtually eliminating tip-over risk—even with a full 80-lb hopper load.
- Elevated rear stand increases foot clearance



Maintenance-Free Gearbox & Axles



Fast-Action Shut-Off Mechanism



Helical Cone Technology

ANDSR2000-PRO STAINLESS

ECHO 85 LB. HOPPER CAPACITY STAINLESS STEEL BROADCAST SPREADER



ECHRB-85S STAINLESS STEEL FRAME

ECHO 85 LB. HOPPER CAPACITY BROADCAST SPREADER



ECHRB-85 POWDER COAT

SPYKER ROTARY SPREADER



SPK80-1S 80 LB. / STAINLESS STEEL
SPK80-1P 80 LB. / POWDER COAT

SPYKER TURFDRESSER PRO SPREADER



SPK80-1S-TD

SPYKER PRO SERIES COMMERCIAL DROP SPREADER



SPKP70-12010

ANTI FOAM



IRRAF1Q 1 QUART

SOLD IN CASE OF 12 QUARTS

K KLEAN
Liquid Tank Cleaner



IRRKLEAN01 1 GALLON

SOLD IN CASE OF 4 GALLONS

TANK CLEANER
Powdered Tank Cleaner



IRRTC01 1 LB. BOTTLE

SOLD IN CASE OF 12 BOTTLES

MEASURING CUP SET



- Molded-in handle will not break off
- American standard measurements denoted by red font
- Metric measurements listed in blue font
- Made of virtually unbreakable polycarbonate

IRRMSET

5 CUP SET FROM 8 OZ TO 1 GAL

MEASURING CUPS



- Molded-in handle will not break off
- American standard measurements denoted by red font
- Metric measurements listed in blue font
- Made of virtually unbreakable polycarbonate

IRRM8 8 OZ CUP

IRRM16 16 OZ CUP

IRRM32 32 OZ CUP

IRRM64 64 OZ CUP

IRRM128 128 OZ CUP

BENCHMARK
Marking Foam Solution



IRRBK01 1 GALLON

SOLD IN CASE OF 4 GALLONS

TREATED WITH GREENACTIVATOR



The root sample above is after six treatments with Greenactivator at the recommendation note the increased branching, overall root volume and length, plus the above ground thicker grass density compared to the root sample below that was taken at same time but left untreated.



GREENACTIVATOR PLUS HUMIC ACID LIQUID FERTILIZER



- A mineral-based liquid fertilizer with a proprietary blend of Humic and Fulvic Acid with a low dose of NPK.
- Increases drought tolerance
- Enhances root development
- Improves plant health by increasing tolerance to disease and pests
- Increases nutrient uptake from the soil
- Absorbs into the plant within 15 minutes, safe for children, pets, and other plants
- Mixes easily with herbicides, pesticides, insecticides, and fungicides – saving you time

STD30000 1 GALLON

STD30002 2.5 GALLON



UNTREATED

Pricing is subject to change.

ECONOMY BOW RAKES



14" HEAD WITH 48" WOOD HANDLE

CORRK10000



LANDSCAPE RAKES



ALL RAKES HAVE A 60" ALUMINUM HANDLE

- CORRK61061 24" HEAD
- CORRK61063 30" HEAD
- CORRK61062 36" HEAD

SPRING BRACE RAKE



22" HEAD WITH 54" WOOD HANDLE

CORRK24003

REPLACEMENT HEAD ONLY

CORRK24003-8



FIXED TINE



19" HEAD WITH 54" WOOD HANDLE

CORRK62001

8" SHRUB HEAD WITH 54" WOOD HANDLE

CORRK62060



EZ-REACHER



- TLTER32 32" EZ-REACHER
- TLTER40 40" EZ-REACHER

CATCHY™ CAN

NEW PRODUCT!



- TLTCC30 30 GALLON

SMALL HAND TOOLS



| ITEM | PART NUMBER | DESCRIPTION |
|------|-------------|------------------------|
| 1 | CORHT69200 | PLANTING MATTOCK |
| 2 | CORCT3010 | HAND TROWEL |
| 3 | CORCT3264 | COMFORT GEL HAND SCOOP |

RUBBERMAID TRASH CANS



- TLTTC10BT 10 GALLON
- TLTTC32BT 32 GALLON

DIGGING SHOVELS

Choose the Right One for Your Needs



- CORSS26000** ROUND POINT SHOVEL W/ 48" WOOD HANDLE
- CORSS27000** SQUARE POINT SHOVEL W/ 48" WOOD HANDLE
- CORSS64103** 3" WIDE TRENCHING SHOVEL W/ 48" WOOD HANDLE
- CORSS64104** 4" WIDE TRENCHING SHOVEL W/ 48" WOOD HANDLE
- SEY49454** STRAIGHT BLADE SPADE W/ 30" D GRIP FIBERGLASS HANDLE - GREAT FOR EDGING BUNKERS
- SEY49453** STRAIGHT BLADE SPADE W/ 48" FIBERGLASS HANDLE GREAT TOOL FOR EDGING BUNKERS
- CORPD20000** POST HOLE DIGGER
- CORUT60050** HAND TAMPER
- SEY49079** SOD LIFTER

TUFFY POLY SCOOP SHOVEL



TLTP6982G

- Made completely of recycled plastic

PLASTIC SCOOP SHOVELS



- 30" D GRIP WOOD HANDLE
CORSS42011
- 48" WOOD HANDLE
CORSS42001



ECONOMY PUSH BROOM

24" HEAD WITH 60" WOOD HANDLE.

CORBM41002



MONSTER BROOM



84" HEAD WITH ALUMINUM HANDLE

SEY82084

OSCILLATING ACTION HOE

4" BLADE WITH 60" WOOD HANDLE
CORSH60000



SINGLE TINE CULTIVATOR

60" Powder Coated Handle

SEY42201



STEEL SCOOP SHOVELS



- 30" D GRIP WOOD HANDLE
CORSS68010



CORONA BYPASS PRUNERS



- CORBP3180 1" PRUNER
- CORBP3160 3/4" PRUNER

CORONA LEATHER SCABBARD



CORAC7220

CORONA GRASS SHEARS



CORGS6750

CORONA TREE PRUNER

Dual Compound Action - 14'



CORTP6870

- Dual Compound action
- Reaches up to 14 Feet
- 13" saw blade
- heavy duty chain drive
- Replacement parts available

CORONA ORCHARD LOPPER

Aluminum Handle - Cuts 2.25" Dia.



- CORAL8482 HIGH-PERFORMANCE 36"
- CORAL8462 HIGH-PERFORMANCE 32"
- CORAL8442 HIGH-PERFORMANCE 26"

CORONA HEDGE SHEAR

9.5" Handle



- CORHS6960 SMOOTH BLADE
- CORHS6920 SERRATED BLADE

FOLDING RAZOR TOOTH SAW



CORRS7265D 10" RAZOR TOOTH

CORONA PRUNING SAW

13" Razor Tooth



CORRS7120 13" SAW

CORONA PRUNING SAW



CORRS7160 21" RAZOR TOOTH SAW

CORONA MACHETE



- CORMA60062 22" BLADE
- CORMA60061 18" BLADE



WHICH TINE IS RIGHT FOR YOU?

- **HEAT TREATED STEEL** - This is our normal tine material that gives you a good quality tine for an affordable cost. This may be a good option where you may hit gravel or rocks and the tine may break no matter what material it is.
- **CARBIDE TIP** - Hardened tip designed for lasting durability. The downside to carbide tip tines is that they may pull the turf up a little and they can wear out above the tip.
- **PHOENIX HARDENED STEEL** - These tines mean you don't have to choose between a long-life, durable carbide tipped coring tine or a clean efficient cut and core with a standard heat treated tine. Phoenix provides both including significantly reduced 'grow-in' period and rust resistance for longer life.

AERIFICATION DISPLACEMENT CHART

This chart can be used to help determine the amount material removed by varying tine size and spacing. Many factors can influence actual results, so use this chart solely as a reference.

| TINE SIZE | 1.25" X 1.25" SPACING | 1.5" X 1.5" SPACING | 2" X 2" SPACING | 2.5" X 2.5" SPACING | 5" X 5" SPACING |
|-----------|-----------------------|---------------------|-----------------|---------------------|-----------------|
| 1/4" | 3.14% | 2.18% | 1.23% | .79% | |
| 3/8" | 7.07% | 4.91% | 2.76% | 1.77% | |
| 1/2" | 12.57% | 8.73% | 4.91% | 3.14% | |
| 5/8" | | 13.64% | 7.67% | 4.91% | |

Look For The Orange Colored Rows For Phoenix Options



Quad Tine Side Eject Coring Tines

| PART NUMBER | TINE DIAMETER | TINE LENGTH | TINE MOUNT |
|---------------|--------------------|-------------|------------|
| CTI1Q-255037 | 1/4" | 5" | 3/8" |
| CTI1Q-375037 | 3/8" | 5" | 3/8" |
| CTI1Q-376037 | 3/8" | 6" | 3/8" |
| CTI1Q-525037 | 1/2" | 5" | 3/8" |
| CTI1Q-526037 | 1/2" | 6" | 3/8" |
| CTI1Q-625037 | 5/8" | 5" | 3/8" |
| CTI1Q-626037 | 5/8" | 6" | 3/8" |
| CTI1QC-255037 | 1/4" - CARBIDE TIP | 5" | 3/8" |
| CTI1QC-375037 | 3/8" - CARBIDE TIP | 5" | 3/8" |
| CTI1QC-525037 | 1/2" - CARBIDE TIP | 4 5/8" | 3/8" |
| CTI1QC-526037 | 1/2" - CARBIDE TIP | 5 5/8" | 3/8" |
| CTI1QC-625037 | 5/8" - CARBIDE TIP | 5" | 3/8" |
| CTI1QC-626037 | 5/8" - CARBIDE TIP | 6" | 3/8" |



HOLES PUNCHED WITH VIPER NOSE QUAD TINES

HOLES PUNCHED WITH STANDARD MINI QUAD TINES

VIPER NOSE QUAD TINES

A Game Changer In Core Aeration

- Viper Nose Quad Tines are a new and unrivaled family of cutting edge quad tines that are minimally intrusive but remove maximum material.
- Remove maximum thatch and material from your Greens
- Have the advantage of minimal disruption to play and fast recovery times while still removing maximum material
- Get maximum durability and longevity out of Viper Nose Quad Tines because of their unique manufacturing process and special heat treating
- Minimal to no plugging of tines during aerification
- Compare to ninja tines in disruption to putting surface, but removes much more material

| PART NUMBER | TINE DIAMETER | TINE LENGTH | TINE MOUNT |
|---------------|---------------|-------------|------------|
| CTI1QV-134337 | 1/8" | 4.3" | 3/8" |
| CTI1QV-255037 | 1/4" | 5" | 3/8" |
| CTI1QV-375037 | 3/8" | 5" | 3/8" |
| CTI1QV-525037 | 1/2" | 5" | 3/8" |
| CTI1QV-526037 | 1/2" | 6" | 3/8" |
| CTI1QV-625037 | 5/8" | 5" | 3/8" |



**VENT TINES
(BAYONET/SLICING TINES)**

- Modified Talon design where the hole remains open and continues to provide gas and water exchange
- Offer exceptional plant respiration benefits for up to three weeks
- Promote drainage and prepare surfaces for sodding, hot spots, or as a pre-seeding prep process
- Resume play immediately after an aerification with little or no impact on putting

| PART NUMBER | TINE DIAMETER | TINE LENGTH | TINE MOUNT |
|---------------|---------------|-------------|--------------|
| CTI2V-626037 | 5/8" | 6" | 3/8" |
| CTI2V-7511070 | 3/4" | 11" | 18 mm |
| CTI2V-754750 | 3/4" | 4.75" | 1/2" |
| CTI2V-754762 | 3/4" | 4.75" | 5/8" |
| CTI2V-756037 | 3/4" | 6" | 3/8" |
| CTI2V-756075 | 3/4" | 6" | 3/4" |
| CTI2V-757037 | 3/4" | 7" | 3/8" |
| CTI2V-757047 | 3/4" | 7" | 12 mm |
| CTI2V-757075 | 3/4" | 7" | 3/4" |
| CTI2V-759547 | 3/4" | 9.5" | 12 mm |
| CTI2VW-759547 | 3/4" | 9.5" | 12 mm dimple |



**TALON TINES
(CROSS TINES)**

- Designed to maximize surface area and minimize plant trauma
- Minimum disturbance to the green so it is possible to resume play immediately after an aerification with little or no impact on putting
- The 'root severing' action promotes root branching for a stronger, healthier root mass
- Improves gas exchange in the soil during hotter months

| PART NUMBER | TINE DIAMETER | TINE LENGTH | TINE MOUNT |
|--------------|---------------|-------------|------------|
| CTI2T-106075 | 1" | 6" | 3/4" |
| CTI2T-374750 | 3/8" | 4.75" | 1/2" |
| CTI2T-376037 | 3/8" | 6" | 3/8" |
| CTI2T-376075 | 3/8" | 6" | 3/4" |
| CTI2T-504737 | 1/2" | 4.75" | 3/8" |
| CTI2T-506037 | 1/2" | 6" | 3/8" |
| CTI2T-506075 | 1/2" | 6" | 3/4" |
| CTI2T-754737 | 3/4" | 4.75" | 3/8" |
| CTI2T-756075 | 3/4" | 6" | 3/4" |



MACHINE ALLOY SIDE EJECT CORING TINES



| PART NUMBER | TINE DIAMETER | TINE LENGTH | TINE MOUNT |
|--------------|---------------|-------------|------------|
| CTI1S-505075 | 1/2" | 5" | 3/4" |
| CTI1S-506075 | 1/2" | 6" | 3/4" |
| CTI1S-624575 | 5/8" | 4.5" | 3/4" |
| CTI1S-625075 | 5/8" | 5" | 3/4" |
| CTI1S-626075 | 5/8" | 6" | 3/4" |
| CTI1F-756075 | 3/4" | 6" | 3/4" |

CARBIDE TIP SIDE EJECT CORING TINES



| PART NUMBER | TINE DIAMETER | TINE LENGTH | TINE MOUNT |
|---------------|--------------------|-------------|------------|
| CTI1CS-374562 | 3/8" - CARBIDE TIP | 4.5" | 5/8" |
| CTI1CS-376075 | 3/8" - CARBIDE TIP | 6" | 3/4" |
| CTI1CS-505075 | 1/2" - CARBIDE TIP | 5" | 3/4" |
| CTI1CS-625075 | 5/8" - CARBIDE TIP | 5" | 3/4" |

FAIRWAY SIDE EJECT CORING TINES



| PART NUMBER | TINE DIAMETER | TINE LENGTH | TINE MOUNT |
|----------------|--------------------|-------------|------------|
| CTI1F-756075 | 3/4" | 6" | 3/4" |
| CTI1F-756087 | 3/4" | 6" | 7/8" |
| CTI1FC-756075 | 3/4" - CARBIDE TIP | 6" | 3/4" |
| CTI1FCH-816075 | 13/16" | 6" | 3/4" |
| CTI1FCH-875587 | 7/8" | 5.5" | 7/8" |

ECONOMY ROLLED SIDE EJECT CORING TINES



| PART NUMBER | TINE DIAMETER | TINE LENGTH | TINE MOUNT |
|--------------|--------------------------|-------------|------------|
| CTI1E-625775 | 5/8" | 5.75" | 3/4" |
| CTI1E-625787 | 5/8" | 5.75" | 7/8" |
| CTI1E-755775 | 3/4" | 5.75" | 3/4" |
| CTI1E-755787 | 3/4" | 5.75" | 7/8" |
| CTI1E-108510 | 1" - CLOSED SPOON TINE | 8.5" | 2 BOLT |
| CTI1E-757575 | 3/4" - CLOSED SPOON TINE | 7.5" | 1 BOLT |



SOLID ROUND TINES

- Made of 4140 alloy steel and designed to provide the longest life possible
- Great for fairways, tees & surrounds



| PART NUMBER | TINE DIAMETER | TINE LENGTH | TINE MOUNT |
|--------------|----------------|-------------|------------|
| CTI2-204537 | 20" | 4.5" | 3/8" |
| CTI2-205537 | 20" | 5.5" | 3/8" |
| CTI2-254037 | 1/4" | 4" | 3/8" |
| CTI2-255037 | 1/4" | 5" | 3/8" |
| CTI2-255050 | 1/4" | 5" | 1/2" |
| CTI2-255075 | 1/4" | 5" | 3/4" |
| CTI2-256037 | 1/4" | 6" | 3/8" |
| CTI2-256075 | 1/4" | 6" | 3/4" |
| CTI2-375037 | 3/8" | 5" | 3/8" |
| CTI2-375050 | 3/8" | 5" | 1/2" |
| CTI2-375075 | 3/8" | 5" | 3/4" |
| CTI2-376037 | 3/8" | 6" | 3/8" |
| CTI2-376075 | 3/8" | 6" | 3/4" |
| CTI2-505075 | 1/2" | 5" | 3/4" |
| CTI2-506037 | 1/2" | 6" | 3/8" |
| CTI2-506075 | 1/2" | 6" | 3/4" |
| CTI2-625075 | 5/8" | 5" | 3/4" |
| CTI2-626037 | 5/8" | 6" | 3/8" |
| CTI2-626075 | 5/8" | 6" | 3/4" |
| CTI2-627075 | 5/8" | 7" | 3/4" |
| CTI2-755075 | 3/4" | 5" | 3/4" |
| CTI2-756075 | 3/4" | 6" | 3/4" |
| CTI2-757075 | 3/4" | 7" | 3/4" |
| CTI2-757087 | 3/4" | 7" | 7/8" |
| CTI2-877087 | 7/8" | 6.5" | 7/8" |
| CTI2-106075 | 1" | 6" | 3/4" |
| CTI2P-255037 | 1/4" - PHOENIX | 5" | 3/8" |
| CTI2P-256037 | 1/4" - PHOENIX | 6" | 3/8" |
| CTI2P-375037 | 3/8" - PHOENIX | 5" | 3/8" |
| CTI2P-376037 | 3/8" - PHOENIX | 6" | 3/8" |



L NEEDLE TINES

- L shaped design for needle tine mounting block
- Great tool for gas exchange during hot months

| PART NUMBER | TINE DIAMETER | TINE LENGTH |
|--------------|---------------|-------------|
| CTI2E-204920 | 1875" | 4.875" |
| CTI2E-206520 | 5MM | 6.5" |
| CTI2E-314931 | .3125" | 4.875" |
| CTI2E-317531 | 5/16" | 7.5" |



JOB SAVER TINES

- The best tool for rapid repair of damaged turf.
- Overseeding greens becomes easier than ever with exclusive attachments for your power aerifier
- Beefed up the spring action stripper plates prevent tearing or lifting of turf
- Precision crafted from the highest quality materials to perform at peak operating levels.
- Preparing the perfect seed bed with a "jobsaver" allows an area to be kept in play.
- The 1/4" diameter spikes create the perfect seed bed, yet allow areas to be kept in play
- Keeps greens in play during seeding process
- 72 holes per stroke, sold in a set of 6



PAR546571 TORO PROCORE 648 (SET OF 6)

CORE COLLECTOR

Collects and Piles Plugs



The Turf Pride Core Collector is an accessory that can save you time and labor costs when core removal is necessary.

- As your aerifier is operating, the Core Collector picks up, contains and moves the cores to the collar
- Cores are deposited on collar when aerator is lifted at end of pass
- Can be mounted in a matter of minutes on walk behind and tractor drawn aerifiers & removal is just as simple
- Optional brush attachment helps work in topdressing sand at the same time.



| | |
|---------------|--|
| TP-CC-48-T | TORO PRO CORE 648 |
| TP-CC-36-T | TORO MODEL 09120 |
| TP-CC-86-T | TORO 864 |
| TP-CC-40-D | JOHN DEERE 1000 |
| TP-CC-36-D | JOHN DEERE 800 |
| TP-CC-60-D | JOHN DEERE 1500 |
| TP-CC-24-GA | RYAN GREENSAIRE 24 |
| TP-CC-30-GA | RYAN GREENSAIRE 30 |
| TP-CC-48-T-TP | SPECIAL BOTTOM THIN PLATE FOR COLLECTING 1/4" PLUGS ONLY |
| TP-CC-BA | BRUSH ATTACHMENT |

OPTIONAL BRUSH ATTACHMENT

CORE HOG

Limited Quantity Available



PAR1075 UNIVERSAL
PAR1076 TORO FLEX 21

ACCUFORM PLUG PUSHER

36" (91.4 cm) Aluminum Head



PAR13240

CUP PLUGS

Protect Holes While Aerifying



Packaged in sets of 9

PAR1070 REGULATION CUP
PAR1071 PRACTICE CUP

SWEEP-N-FILL TURF BRUSH



TLTSNFTB

- Eliminates bruising and turf injury
- Removes grain from putting surface
- Fills aerified holes in only 2 – 3 passes
- Provides fastest clean up of aerified greens
- Lifts lateral shoots and matted turf
- Reduces need for verticutting and vertical grooming
- 6" ground clearance in transport mode
- Can be pulled by golf cart or light truckster
- 54" working width, 66" overall width

GREENSGROOMER

- The GreensGroomer® is an integral part of a total turf conditioning program and won't scuff, bruise, or damage turf.
- Effectively moves both wet and dry topdressing.
- Brushes off heavy dew and grass clumps.
- Equally balanced for smooth operation.
- assists in controlling grain, promotes leaf healthiness and grass density, and can reduce the frequency of verticutting.
- Choose between Black premium brushes or white heavy duty brushes

- GRG920E GREENSGROOMER W/ BLACK PREMIUM BRUSHES
- GRG920HDE GREENSGROOMER W/ WHITE HEAVY DUTY BRUSHES
- GRG920000 REPLACEMENT BRUSH SET - PREMIUM BLACK FOR 920 (NEW MODEL)
- GRG920100 REPLACEMENT BRUSH SET - HEAVY DUTY WHITE FOR 920 (NEW MODEL)
- GRG230000 REPLACEMENT BRUSH SET - PREMIUM BLACK FOR 720 (OLD MODEL)
- GRG202000 REPLACEMENT BRUSH SET - HEAVY DUTY WHITE FOR 720 (OLD MODEL)
- GRG944HD FAIRWAY GROOMER W/ WHITE HEAVY DUTY BRUSHES
- GRGSTR2 SPRING TINE ATTACHMENT



ORIGINAL GREENSGROOMER



FAIRWAY GROOMER



REPLACEMENT BRUSHES



SPRING TINE RAKE

GREENSWAGON UTILITY TRANSPORT

- Easy, versatile alternative to high-cost OEM units.
- It takes just seconds to pull the ramp out, load your mower
- Specially designed "wings" reinforced wheel housings protect the unit from damaging obstacles
- Outfitted with high-quality roller bearings inside the wheel assembly
- Very stable, with a 55 inch wide stance
- Each unit is tailored to your unit with precision designed brackets and hardware
- 10 gauge Steel
- 57" W x 16" H x 87" L (with draw bar)



- | | |
|--|--|
| GRG740 GREENSWAGON UTILITY TRANSPORT- NO BRACKET | GR7468 TORO 800 MOWER BRACKET |
| GR7420 TORO 1018, 2021 MOWER BRACKET | GR7466 TORO 500 LEFT SIDE MOWER BRACKET |
| GR7456 JACOBSEN 526 MOWER BRACKET | GR7467 TORO 500 RIGHT SIDE MOWER BRACKET |
| GR7457 JACOBSEN 522 MOWER BRACKET | GR7462 JOHN DEERE 1080AI220A MOWER BRACKET |
| GR7458 JACOBSEN 518 MOWER BRACKET | GR7472 JOHN DEERE 180B/C MOWER BRACKET |
| GR7459 JACOBSEN PGM I RANSOM 22 MOWER BRACKET | GR7471 JOHN DEERE 220B/C MOWER BRACKET |
| GR7475 JACOBSEN TC-22 MOWER BRACKET | GR7473 JOHN DEERE 260B/C MOWER BRACKET |
| GR7479 TORO FLEX 18 MOWER BRACKET | GR7481 TORO FLEX 1800 MOWER BRACKET |
| GR7469 TORO FLEX 21 MOWER BRACKET | GR7491 JD 180/220/260 - B/C/E/SL BRACKET |
| GR7480 TORO FLEX 2100 MOWER BRACKET | GR7482-18 BARONESS LM 18 MOWER BRACKET |
| GR7460 TORO FLEX 1000 MOWER BRACKET | GR7482-56 BARONESS LM 56 MOWER BRACKET |
| GR7461 TORO FLEX 1600 MOWER BRACKET | GR7482-66 BARONESS LM 66 MOWER BRACKET |

DEW DRAGGIN

Quickly Remove Dew By Hand Or Behind A Cart



- A fast and cost effective way to remove dew or disperse clippings from fairways or Greens.
- The dew draggin is 25 feet wide and only 30 pounds.
- Optional handle attachment allows you to use on Greens without a vehicle.

PAR555690 DEW DRAGGIN

DRAG BRUSH Center Unit Only



STD52000 CENTER DRAG UNIT
STD52013 54" REPLACEMENT BRUSH
(DRAG UNIT REQUIRES 2 BRUSHES)

- Long-time classic and favorite among superintendents.
- Gently and evenly works top dressing material into the green and helps control thatch when used before mowing.
- Extensions available for bigger jobs; hinged and weighted to help manage contours and uneven areas.
- 26" H x 54-1/2" W

DRAG BRUSH Wing Units Only



STD52050 WING UNITS ONLY
(SET OF 2)
STD52063 27" REPLACEMENT BRUSH
(4 BRUSHES REQUIRED FOR BOTH WINGS)

NOTE- REPLACEMENT BRUSHES ARE SOLD INDIVIDUALLY.
CENTER DRAG UNIT REQUIRES 2 BRUSHES

NOTE- REPLACEMENT BRUSHES ARE SOLD INDIVIDUALLY.
WING UNIT REQUIRES 4 BRUSHES

EASY SWEEP FAIRWAY DRAG NETS



- The easiest and most affordable method to break up grass clippings in fairways and roughs
- Pull with cart or mount behind fairway or rough mower
- Highest quality drag nets available
- Drag net does not include frame - use PVC or stock metal to mount to cart or mower
- Reduces labor costs and improves turf conditions
- Rolls up - Easy to store and transport
- Cultural practice to prevent DOLLAR SPOT
- # 42 uv treated 2" mesh heavy duty polyester netting
- 3/8" braided rope perimeter
- 3/8" Galvanized chain
- Choose whether you want 1 or 2 chains

PWFDN7X11-1 7 FEET WIDE X 11 FEET LONG - 1 CHAIN
PWFDN7X11-2 7 FEET WIDE X 11 FEET LONG - 2 CHAINS
PWFDN10X12-1 10 FEET WIDE X 12 FEET LONG - 1 CHAIN
PWFDN10X12-2 10 FEET WIDE X 12 FEET LONG - 2 CHAINS

Pricing is subject to change.

SANDPIPER COCOMAT

Complete Mats With Tow Assembly



- The original, high quality mat
- Natural cocoa fibers offer superb brooming action.
- Thick backing provides multi-season use.
- Quick effective filling of aerated holes.
- Won't damage tender grasses as a chain mat will.
- Versatile mounting harness - tow with a cart, mower or any prime mover.
- Can be used alone or in conjunction with mechanical top dressers
- Towing frame & all components are weather tolerant

**SHIPPED FULLY ASSEMBLED, READY TO WORK.
SPECIAL SIZES AND REPLACEMENT MATS AVAILABLE.**



COC4X6 4' X 6' MAT

COC5X6 5' X 6' MAT

COC6X6 6' X 6' MAT

COCO DRAG MOP

Touch Up Areas Or Get Those Hard to Reach Spots - Great for Baseball Infields



- Perfect for small job sites, spot touch up after aerification or areas that are hard to reach with an utility vehicle
- Uses the same material as a pull behind coco mat
- Great for infield skin on baseball fields
- Mop comes with a 66 inch aluminum handle
- Mop head is 24 inches x 24 inches



STD53060

MONSTER BROOM

- Perfect for small job sites, spot touch up after aerification or areas that are hard to reach with an utility vehicle
- 84" wide head
- Lightweight and easy to pull behind



84" HEAD WITH ALUMINUM HANDLE

SEY82084

24" PUSH BROOM

2-Bristle Design, Bamboo Handle



- Ideal for sweeping sidewalks, concrete slabs and floors
- Features both coarse and fine 3 in. bristles for greater efficiency
- 24 in. Wide head for single-pass removal of unwanted material
- 60 in. Bamboo handle offers improved strength-to-weight ratio



CORBM41002

KEYSTONE DRAG MATS

Flexible Style



This heavy duty, all purpose mat is a standard maintenance tool on golf courses and sports fields. Whether for dragging the infield or breaking up aerification plugs, this mat does it all. Our mats come with the tow rope and hardware included.

- Heavy duty
- Rust resistant galvanized finish
- Reversible - use either side
- Rolls up like a carpet for easy cleaning
- Smooth, level surface
- Rugged construction

| | |
|-----------------|--------------------|
| KEY48X48 | 4'W X 4'L DRAG MAT |
| KEY48X60 | 4'W X 5'L DRAG MAT |
| KEY48X72 | 4'W X 6'L DRAG MAT |
| KEY60X60 | 5'W X 5'L DRAG MAT |
| KEY72X72 | 6'W X 6'L DRAG MAT |
| KEY72X96 | 6'W X 8'L DRAG MAT |
| KEY60X72 | 5'W X 6'L DRAG MAT |
| KEY36X48 | 3'W X 4'L DRAG MAT |

Flexible steel drag mats can be customized into nearly any size. Call for other options.

KEYSTONE DRAG MATS

HD Series



- A Par West Exclusive Product, the hd series drag mat is a bulkier version of the keystone mat
- Adds more weight and heavier duty for working sand topdressing into fairways
- Breaks fairway plugs up better on fairways
- Over 3 times as strong as the original keystone mat
- **Chain attachment sold separately**

| | |
|-------------------|---------------------------------|
| KEYHD48X48 | 4'W X 4'L MAT |
| KEYHD72X48 | 6'W X 4'L MAT |
| KEYHD72X72 | 6'W X 6'L MAT |
| KEYHDCH72 | 72" SAFETY TOW CHAIN ATTACHMENT |



Call for other available size options.



CORE BUSTER DRAG MAT

Break up cores easier, faster, and better than ever before. The new Core Buster Drag Mat is the best performing and most versatile drag mat available

| | |
|-------------------|---|
| PAR1081 | DRAG MAT I: 160" X 60" (8 PANEL X 3 PANEL) |
| PAR1080 | DRAG MAT II: 100" X 60" (5 PANEL X 3 PANEL) |
| PAR1080-10 | INDIVIDUAL PANEL (20 IN. X 20 IN.) |
| PAR1080-11 | HARDWARE KIT |
| PAR1080-12 | DRAW BAR |

Pricing is subject to change.

HIGH TRAFFIC MATTING



- Textured surface reduces the risk of slippage
- Available in two thicknesses to meet your specific application: Sikagard Lightweight Mat:
- Lighter construction for easy cleaning and handling with a nominal thickness of 1/4"
- Additional porosity makes it excellent for indoor wet areas
- Thicker construction provides additional durability with a nominal thickness of 3/8".
- Antimicrobial formula guards against the growth of mildew, fungi, and bacteria.
- Porous Design:
- Allows moisture to flow through footing surface, eliminating standing water
- Allows evaporation beneath mat for a quick dry
- Soft construction provides comfort for bare foot traffic
- Protects bare feet from splinters on wood surfaces
- Lightweight for easy handling
- Will not hold or absorb water
- Trims easily with a razor knife for custom fitting in all areas
- Cleans easily with sweeping or wash down

PEM225 2' WIDE X 25' LONG ROLL

PEM325 3' WIDE X 25' LONG ROLL

PEM625 6' WIDE X 25' LONG ROLL

MATTING COLOR OPTIONS

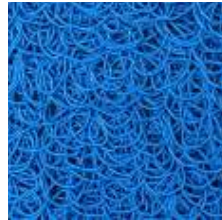

BLUE



HUNTER GREEN

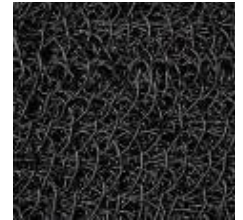

BLACK

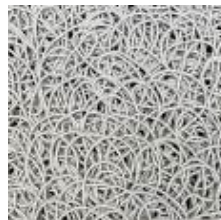

GREY



BROWN



SANDSTONE



- Excellent for bridges and high traffic areas
- Environmentally friendly resilient non-porous flooring
- Shock Absorbent. Slip Resistant (Wet & Dry Areas).
- Not affected by cold weather; will not expand or become brittle or hard
- Will not harbor or promote bacteria
- 3/8" (9.5mm) – for heavy duty commercial applications

TLTRR3825BK 3/8" X 4' X 25' - BLACK

TLTRR3850BK 3/8" X 4' X 50' - BLACK



RR FLOOR PROTECTOR ROLLS

3/8" x 4' x Custom Length



GEOGRID CELLULAR PAVING SYSTEM

For Landscaping Stabilization and Erosion Control

- 25 Ton Load Capacity
- 19.5"X19.5"X1.6"
- 100% recycled high-density polyethylene (HDPE)
- Interlocking design for fast installation
- Durable and lightweight
- Can be filled in with decorative stones, seeded with grass or with high visibility inserts
- GeoGrid® ground reinforcement and stabilization grids can equal or better the axle or point load performance of other currently available 40mm or 50mm cellular geopavers.

TLTGEO20 BLACK TILE

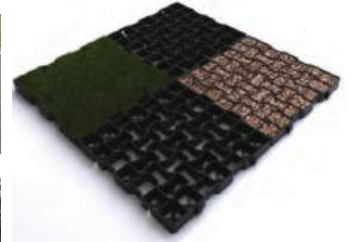

MAMBAMAT® COMPOSITE MAT

Turf Protection / Traffic Mat - 95 Ton Capacity

- Ergonomic orientation with 8 standard hand holes, significantly improves ease of handling for users
- Designed to support weights of up to 95 tons helping to preserve the condition of the property, avoiding expensive repair or restoration expenses
- Reliable pedestrian traction mitigates the risks of accidents and injuries
- Flexible construction follows the contours of the ground, delivering effective access solutions on sloping or undulating ground conditions
- All mats ship freight truck

TLTMM28 2 FEET X 8 FEET

TLTMM36 3 FEET X 6 FEET

TLTMM38 3 FEET X 8 FEET

TLTMM48 4 FEET X 8 FEET



Discounts for orders over 10 units.

CUSHION TREAD

Safety And Anti-Fatigue Matting

- Cushion-Tred™ is made from a resilient rubber compound that can withstand many of the commonly found industrial chemicals, cutting fluids, oils, and greases.
- A large hole drainage system facilitates the removal of liquid and debris from the work area.
- Multiple mats can be affixed together with optional connector strips

TLT55050033BL 3 FEET X 3 FEET

TLT550S0035BL 3 FEET X 5 FEET



Pricing is subject to change.

**EVERGREEN TURF COVERS
CALL FOR PRICING**

7 YEAR WARRANTY

WHITE ORIGINAL TURF COVER

| | |
|-------------------|------------|
| EVG10X50W | 10' x 50' |
| EVG20X50W | 20' x 50' |
| EVG50X60W | 50' x 60' |
| EVG60X90W | 60' x 90' |
| EVG70X90W | 70' x 90' |
| EVG80X110W | 80' x 110' |

CUSTOM SIZES

10 YEAR WARRANTY

GREEN PREMIUM TURF COVER

| | |
|-------------------|------------|
| EVG10X50G | 10' x 50' |
| EVG20X50G | 20' x 50' |
| EVG50X60G | 50' x 60' |
| EVG60X90G | 60' x 90' |
| EVG70X90G | 70' x 90' |
| EVG80X110G | 80' x 110' |

CUSTOM SIZES

12 YEAR WARRANTY

SILVER RADIANT TURF COVER

| | |
|-------------------|------------|
| EVG10X50S | 10' x 50' |
| EVG20X50S | 20' x 50' |
| EVG50X60S | 50' x 60' |
| EVG60X90S | 60' x 90' |
| EVG70X90S | 70' x 90' |
| EVG80X110S | 80' x 110' |

CUSTOM SIZES



How An Evergreen Turf Cover Can Help You

- Increase soil temperatures by 10 degrees
- Speed up germination rates
- Reduce or eliminate foot traffic
- Retain moisture

TURF PROTECTION MESH

The durable net protects new turf from wheel rutting and ensures a good grasp for grass roots.

- Looks natural
- Reduces stormwater run off
- Resists wheel rutting that damages new grass
- Net ensures deep grass roots for healthy grass
- UV stabilized for long-lasting "go green" color
- Secure perimeter using inexpensive tenax staples every 3 ft.
- Use to protect the ground from damage caused by vehicles, pedestrians, and more
- Highly recommended to install in the spring and fall growing seasons for best results
- Versatile and can be used in commercial and residential areas in need of ground protection



TLTTRMAT 6'7" X 100' ROLL \$680.00

SEED GERMINATION BLANKET



- 1.5 oz thick for maximum warmth
- Great for improving the speed of germination by trapping heat and moisture
- Lightweight and easy to use
- UV stabilized
- Sized special for long areas of divots

| | |
|---------------------|------------|
| GCATC-7X50 | 7' x 50' |
| GCATC-6X100 | 6' x 100' |
| GCATC-10X100 | 10' x 100' |
| GCATC-14X100 | 14' x 100' |
| GCATC-12X500 | 12' x 500' |

206 POWER EQUIPMENT

- Easily picks up grass, leaves, twigs, and debris
- Comes with 10 cu ft capacity mesh bottom basket, solid bottom optional for additional cost
- highest quality drag nets available
- Polypropylene, steel-backed brushes
- 8 Brushes, staggered in four rows
- Variable height adjustment independent of the frame
- 10-1/2" X 2-1/2" wheels
- Easily towed by any equipment with a rear hitch hole 3/8" galvanized chain
- Tow with a front engine tractor, zero turn mower, atv, or golf cart
- Single unit or triple gang

- TP-SR-1000-4** SINGLE SWEEP UNIT
- TP-SR-3000-4** TRIPLE GANG SWEEP UNIT
- TPP360904** MAGNET ADD-ON
- TPP360905** REAR BRUSH KIT ADD-ON
- TPP360906** HOPPER EXTENSION ADD-ON

FLOOR OPTIONS (MUST SELECT 1 WHEN ORDERING)

- P360900** STEEL MESH FLOOR
- P360901** NON-MESH NYLON FLOOR



Rear Brush & Magnet Add-on



SWEEP-RITE LAWN SWEEPER



- Engineered for professional turf maintenance.
- Available in 11', 15', and 17' tow behind models and 3-point hitch versions
- Include full width rear and front roller, and on the 3-point hitch models standard with front casters for trimming around bunkers and cart paths.
- offset hitch providing close cuts around trees and bushes, greatly improving production and reduce the need for string trimmer. Variable Height Adjustment independent of the frame
- Medium and heavy duty blades are also available.

- TP-GT-3130** ROLLER MOWER, 11'
- TP-GT-3180** ROLLER MOWER, 15'
- TP-GT-3204** ROLLER MOWER, 17'

ROLLER MOWER



THREE POINT HITCH FINISH MOWER

Turn Your Tractor Into A Turf Mowing Machine

- 43" – 57" – 72" Cutting Widths
- Minimum Required HP 15-35 to meet the needs of today's
- Quick Hitch compatibility on all models allows for easier hook up
- Contour of terrain with 3 anti-scalp rollers
- Cutting height adjustment is made with quick placed spacers from 1/2" to 3"
- Adjustable Spring-Loaded idlers maintain proper belt tension



- TP-TPH-GT143** 43" CUT
- TP-TPH-GT157** 57" CUT
- TP-TPH-GT172** 72" CUT
- TP-TPH-GT143-R** 43" CUT EQUIPPED W/ REAR ROLLERS
- TP-TPH-GT157-R** 57" CUT EQUIPPED W/ REAR ROLLERS
- TP-TPH-GT172-R** 72" CUT EQUIPPED W/ REAR ROLLERS

Visit www.parwest.com or call us directly for more information and videos on all three products!

Pricing is subject to change.



GREENMAN 19"
Hover Mower



- Maruyama CER800U 2-stroke engine
- Wide-ranging 52" adjustable handles provide extreme reach on sloped surfaces
- Mulches as it cuts
- Engine stop system using the convenient OPC lever for added safety
- **California Compliant**

- GHG190** 19" 2-CYCLE ENGINE
- GH3010670** TRI-BLADE SET (SET OF 3)
- GH3010700** 19" STRAIGHT/BAR BLADE
- GH4012561-M** 18" HANDLE EXTENSION KIT (MARUYAMA ENGINE)
- GHHR-190** HIGH-RISE KIT (1.9" INCREASE IN CUTTING RANGE)



STANDARD STAINLESS STEEL BLADE SYSTEM
Hardened Stainless Steel
Reversible and Sharpenable



QC BLADE SYSTEM
Hardened Stainless Steel
Surrounded By Nylon Casing

- AFF-15** 15", 2 CYCLE JAYU ENGINE (NOT AVAIL. IN CA)
- AFF-19** 19" DUCAR 4 CYCLE ENGINE (NOT AVAIL. IN CA)

ADD-ONS & REPLACEMENT PARTS

- AFSE00603** QC BLADE KIT (PACK OF 6)
- AFSE01206** QC BLADE KIT (PACK OF 60)
- AFSE02412** STAINLESS BLADES (PACK OF 3)
- AFSE18370** BLADE BOLT KIT (PACK OF 3)
- AF1222** DISC ONLY FOR 19" HOVER MOWER
- AF1519** DISC ONLY FOR 15" HOVER MOWER



AIR FORCE
Hover Mower



Air Force offers the best power, performance and durability. Better materials and modern construction methods make Air Force the best hover mower.

- STANDARD SS BLADE SYSTEM** **QC BLADE SYSTEM**

POWER TRIM COMMERCIAL EDGER

- The industry standard for edging cart paths and curbs
- 4 HP honda engine
- All parts available in equipment maintenance section of this catalog

- PWT308H** 118CC HONDA ENGINE
- PWT200-8** 127CC BRIGGS & STRATTON ENGINE



POWER TRIM POWER BRUSH

- The industry standard for edging cart paths and curbs
- Honda GX35N Engine
- Bristle Brush Dimensions L – 22 inches x W 10 inches
- Great for artificial turf fields and backyard putting greens

PWTPBR-1000



ATOM PRO CART PATH EDGER
Walk Behind Edger

- Safety Throttle Interlock with 1/2 Throttle Lock for Easy Starting & Finger Tip On/Off Ignition Switch
- Powerful Honda Durable Full Crank Commercial Engine
- Fully Enclosed Solid Steel 12mm Precision Ground Transmission Shaft
- Large 150mm (6") Rubber Tyred Wheel with Axle Seals



ATOM WIRE WHEEL BRUSH EDGER BLADE

- ATMCPE4-MAX** ATOM MAX PRO - HONDA GX 50CC
- ATMCPE4** ATOM PRO - HONDA GX 35CC
- ATM49000** WIRE BRUSH BLADE
- ATM43105** BLADE SET

ATOM DELUXE EDGER
Award-Winning Lawn Edger

- Safety Throttle Interlock and fingertip on/off ignition
- Easy lifting carrying handle
- highly maneuverability wheelbarrow action means you can edge along curbs and gutters, around tight corners, garden plots, and by simply tilting the edger sideways you can edge up against walls and fences
- Quality 25cc Honda 4-Stroke engine.
- NOT CA COMPLIANT



- ATMDLX** DELUXE EDGER
- ATM43105** BLADE SET

208 POWER EQUIPMENT

ECHO SRM2620 TRIMMER

Commercial String Trimmer



- 25.4 CC professional grade two-stroke engine
- Easy start
- Speed-Feed 400 cutting head that re-loads in seconds without disassembly

ECHSRM-2620AAC 25.4CC PRO TRIMMER

POWER ROTARY SCISSORS

Convert Trimmer to Recipicator



- Convert any brand weedeater into a recipicator at a fraction of the price of buying a complete unit
- Great for edging and trimming
- Prevents scattering
- Available standard 9.5" or 11" diameter
- Impact resistant
- Will attach to any brand string trimmer or brush cutter
- 11" rotary scissors great for bunkers

TLTPRS9.5 9.5" ROTARY SCISSORS

TLTPRS11 11" ROTARY SCISSORS

ECHO PB2620

Hand Held Blower



- 25.4 cc professional-grade, 2-stroke engine
- 191 MPH performance Low noise, 64 dB(A)* output for noise sensitive environments
- Flared pipe for increased air speed

ECHPB2620C

ECHO COMMERCIAL

Gas Backpack Blowers



ECHPB-580TAAC TUBE THROTTLE (58CC)

ECHPB7910HC HIP THROTTLE (79.9CC)

ECHPB9010TC TUBE THROTTLE (79.9CC)

ECHPB9010HC HIP THROTTLE (79.9CC)

ECHO PPT2620

Commercial Pole Pruner

- 25.4 CC two-stroke engine
- Adjustable oiler to match cutting conditions
- 12" cutting bar



ECHPPT2620C

PE-225 21.2 CC EDGER

With I-30 Starter

- 21.2 cc professional-grade, 2-stroke engine
- Captive wheel mount hardware for easy wheel height adjustability

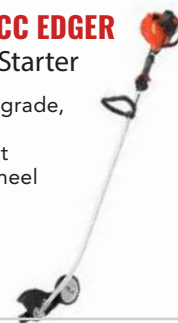

ECHPE-225C

ECHO TOP HANDLE CHAINSAWS



- The lightest gas powered chain saw in North America
- 25 cc - 2-stroke engine
- Clutch-driven oiler for reduced oil consumption
- Choke w/ auto fast idle for easy starting
- Dual post chain break for durability
- 12' & 14" cutting bar

ECHCS-2511TN-12C 12" BAR

ECHCS-2511TN-14C 14" BAR

ECHO GAS SERIES CHAINSAWS



- 50.2 cc professional-grade, 2-stroke engine
- Adjustable clutch-driven oiler - reduces oil consumption
- Decompression valve - for easier starting
- Professional-grade bar and chain for superior cutting performance

ECHCS4010-18C 18" BAR

PRO GARD 2 CYCLE OIL

- Case of 24 - 2.6 ounce bottles (each bottle makes 1 gallon of mixed fuel at 50:1 ratio)
- Case of 12 - 12.8 ounce bottles (each bottle makes 5 gallons of mixed fuel at 50:1 ratio)
- 5 Gallon Pail
- 2.6 ounces makes one gallon of two cycle oil mix at the recommended 50:1 ratio



SHPOIL12 12.8 OZ- CASE OF 12 \$83.50

SHPOIL26 2.6 OZ- CASE OF 24 \$157.75

SHPOIL5P 5 GALLON PAIL \$66.00

ECHO HCS-2810C

20" Double-Sided Hedge Trimmer

- Full-length debris shield for reduced cleanup
- RazorEdge™ 3-sided teeth for longer cutting performance
- 1.4 lbs. lighter than most competitors
- Vibration reducing features for operator comfort



ECHHCS-2810C

See Website for All Current ECHO Product Pricing

Pricing is subject to change.



2.5AH LITHIUM-ION BATTERY



ECHLBP-56V125A

5.0AH LITHIUM-ION BATTERY



ECHLBP-56V250A

8.0AH LITHIUM-ION BATTERY



ECHLBP-56V400A

STANDARD CHARGER



ECHLC-56V2AAB

RAPID CHARGER



ECHLC-56V4AAB

DUAL PORT RAPID CHARGER



ECHLC-56V5A2AB

TOP MOUNT CHARGER

ECHLC-56V1AACC



**BATTERY POWERED BACKPACK BLOWER
DPB-5800T**



ECHDPB-5800TBT BACKPACK BLOWER ONLY
ECHDPB-5800TD2-2 UNIT + (2) 5.0AH BATTERIES & DUAL PORT CHARGER

**549 CFM BATTERY POWERED HANDHELD BLOWER
DPB-2500**



ECHDPB-2500BT HANDHELD BLOWER ONLY
ECHDPB-2500C1 UNIT + 2.5AH BATTERY & STANDARD CHARGER
ECHDPB-2500R2 UNIT + 5.0AH BATTERY & RAPID CHARGER

**TELESCOPING SHAFT POWER PRUNER
DPPT-2600H**



ECHDPPT-2600HBT PRUNER UNIT ONLY
ECHDPPT-2600HR2 UNIT + 5.0AH BATTERY & RAPID CHARGER

**56V FIXED SHAFT POWER PRUNER
DPPF-2100**



ECHDPPF-2100BT PRUNER UNIT ONLY
ECHDPPF-2100C1 UNIT + 2.5AH BATTERY & STANDARD CHARGER

Check out Justrite's Lithium-Ion Battery Charging Storage Cabinet in the Maintenance Shop Supplies section!

**22" DOUBLE SIDED BATTERY POWERED HEDGE TRIMMER
DHC-2300**



ECHDHC-2300BT HEDGE TRIMMER UNIT ONLY
ECHDHC-2300C1 UNIT + 2.5AH BATTERY & STANDARD CHARGER

**22" DOUBLE-SIDED HEDGE TRIMMER
DHC-2200**



ECHDHC-2200BT HEDGE TRIMMER UNIT ONLY
ECHDHC-2200R1 UNIT + 2.5AH BATTERY & RAPID CHARGER

**34" SINGLE-SIDED HEDGE TRIMMER
DHCS-3400**



ECHDHCS-3400BT HEDGE TRIMMER UNIT ONLY
ECHDHCS-3400R1 UNIT + 2.5AH BATTERY & RAPID CHARGER

**17 IN. BATTERY POWERED STRAIGHT SHAFT STRING TRIMMER
DSRM-2600**



ECHDSRM-2600BT STRING TRIMMER UNIT ONLY
ECHDSRM-2600R2 UNIT + 5.0AH BATTERY & RAPID CHARGER

**17 IN. BATTERY POWERED U-SHAPED HANDLE STRING TRIMMER
DSRM-2600U**



ECHDSRM-2600UBT STRING TRIMMER UNIT ONLY
ECHDSRM-2600UR2 UNIT + 5.0AH BATTERY & RAPID CHARGER

**CURVED SHAFT EDGER
DPE-2600**



ECHDPE-2600BT EDGER UNIT ONLY
ECHDPE-2600R2 UNIT + 5.0AH BATTERY & RAPID CHARGER

**BATTERY POWERED PRO ATTACHMENT SYSTEM
DPAS-2100SB**



ECHDPAS-2100SBBT PAS UNIT ONLY
ECHDPAS-2100SBC1 UNIT + 2.5AH BATTERY & STANDARD CHARGER

See Website for All Current ECHO Product Pricing

210 POWER EQUIPMENT



2.5AH LITHIUM-ION BATTERY



ECHLBP-56V125A

5.0AH LITHIUM-ION BATTERY



ECHLBP-56V250A

8.0AH LITHIUM-ION BATTERY



ECHLBP-56V400A

STANDARD CHARGER



ECHLC-56V2AAB

56V 18" BATTERY REAR-HANDLE CHAINSAW DCS-5000



ECHDCS-5000-18BT CHAINSAW ONLY
ECHDCS-5000-18C2 UNIT + 5.0AH BATTERY & STANDARD CHARGER

56V BATTERY TOP HANDLE CHAINSAW DCS-2500T



ECHDCS-2500T-12BT CHAINSAW ONLY
ECHDCS-2500T-12C1 UNIT + 2.5AH BATTERY & STANDARD CHARGER
ECHDCS-2500T-12R1 UNIT + 2.5AH BATTERY & RAPID CHARGER

8.0AH LITHIUM-ION BATTERY



ECHLBP-56V400A

STANDARD CHARGER



ECHLC-56V2AAB

RAPID CHARGER



ECHLC-56V4AAB

DUAL PORT RAPID CHARGER



ECHLC-56V5A2AB

56V BATTERY TOP HANDLE 12" CHAINSAW DCS-2500TN



ECHDCS-2500TN-12BT CHAINSAW ONLY
ECHDCS-2500TN-12R1 UNIT + 2.5AH BATTERY & RAPID CHARGER

TRIMMER AND BLOWER COMBO KIT DCP-BVRVS1B



ECHDCP-BVRVS1B COMBO KIT

TOP MOUNT CHARGER



ECHLC-56V1AACC

BATTERY POWERED 21" PUSH LAWN MOWER DLM-2100



ECHDLM-2100BT LAWN MOWER ONLY
ECHDLM-2100C2 UNIT + 5.0AH BATTERY & RAPID CHARGER

BATTERY POWERED 21" SELF-PROPELLED 3-IN-1 MOWER DLM-2100SP



ECHDLM-2100SPBT LAWN MOWER ONLY
ECHDLM-2100SPC2 UNIT + 5.0AH BATTERY & RAPID CHARGER

TRANSPORTER TRAILER

Lowers & Tilts To The Ground For Easy Loading & Unloading

The Transporter lowers to ground level for easy loading of low-clearance equipment like aerators, greens mowers, and golf carts. Features a manual winch for raising and lowering or an optional electric winch, allowing one person to load disabled equipment effortlessly.



- Overall Length - 16'
- Wheel Base- 87"
- Ground Clearance to Bottom of Bed - 10"
- Bed Length - 100" Bed
- Bed Width - 55.5"
- Tires - 205/75-R14

TPTR-1 TRANSPORT TRAILER

TPTR-1-EW ELECTRIC WINCH ADD-ON

See Website for Current ECHO Product Pricing

BROYHILL SILHOUETTE GREEN MOWER TRAILERS

SILHOUETTE I

42" W X 32" L X 9"H
Can Carry One Mower



BROI-2628A-1 SILHOUETTE I

SILHOUETTE II

48" W X 61" L X 9"H
Can Carry Two Mowers



BROI-2628A-2 SILHOUETTE II

SILHOUETTE III - HEAVY DUTY

62" W X 61" L X 25"H
Off Road Use Only



BROI-2628A-3 SILHOUETTE III

Pricing is subject to change.

EDGER BLADES

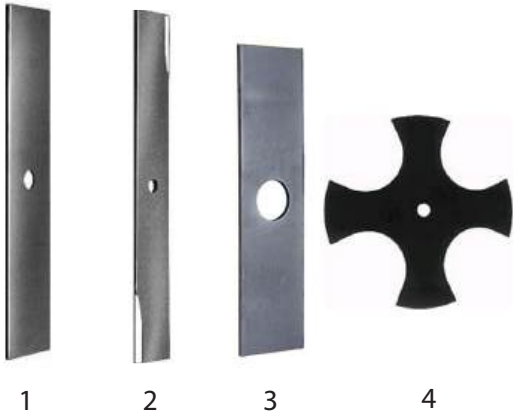

- 1 - SHP2670 1/2" HOLE X 10" BLADE UNSHARPENED
- 2 - SHP2673 1/2" HOLE X 10" BLADE SHARPENED
- 3 - SHP2663 1" HOLE X 8" LONG STICK EDGER BLADE
- 4 - SHP2658 4 STAR 1/2" HOLE EDGER BLADE

TRIMMER LINE

5 LB. Spools

- SHPTLR095 .095 ROUND RED
- SHPTLR105 .105 ROUND RED
- SHPTLR130 .130 ROUND RED
- SHPTLR155 .155 ROUND RED
- SHPTLS095 .095 DIAMOND ORANGE
- SHPTLS105 .105 DIAMOND ORANGE
- SHPTLS130 .130 DIAMOND ORANGE
- SHPTLV095 .095 VORTEX BLACK
- SHPTLV105 .105 VORTEX BLACK
- SHPTLV130 .130 VORTEX BLACK



BUMP & FEED UNIVERSAL REPLACEMENT HEAD



- SHP10231 FITS MOST TRIMMERS
- SHP10638 FITS STIHL TRIMMERS

MANUAL UNIVERSAL REPLACEMENT HEAD



SHP9383

KWIK LOAD REPLACEMENT HEAD



- SHPKL730 3 STRING HEAD \$77.75
- SHPKL650 2 STRING HEAD \$61.75



EDGIT PRO TRIMMING GUIDE

- EDG1001 ECHO TRIMMERS
- EDG1006 SHINDAIWA TRIMMERS
- EDG1027 STIHL TRIMMERS
- EDG1028 REDMAX TRIMMERS

BRUSH CUTTER BLADES



10" X 1" - 8 TOOTH

SHP4279



10" X 1" - 80 TOOTH

SHP4278



10" X 1" - 3 TOOTH

SHP4413

TRIMMER LINE CUTTER



SHP12820

- No need to have wire cutters for every crew member
- Simple to use and safe with no exposed cutting edges
- Put on your key ring and have ready when it is time to refill your trimmer



CHAMPION SPARK PLUGS



- Champion CJ8
- Shop pack is 24 plugs

SHP2504 4-PACK

SHP2529 SHOP PACK



- Champion RV17YC

SHP8073 4-PACK

NGK SPARK PLUGS



- NGK BPR5ES

SHP2538 4-PACK



- NGK BKR5E
- Shop pack is 100 plugs

SHP9872 4-PACK

SHP11648 SHOP PACK



- NGK CMR7H

SHP10188 10-PACK



- NGK BPM8Y

SHP10020 10-PACK

STONE FUEL FILTER

For Trimmers & Blowers

- Fits most trimmers and small equipment

SHP9024 SMALL

SHP9025 LARGE



FUEL SURGE PUMP PRIMER BULBS



SHP9478 SMALL (TRIMMERS & BLOWERS)

SHP9948 LARGE (CHAINSAWS)

LARGE FUEL IN-LINE FILTER



SHPGF

STARTER ROPE

100' Roll

SHP9341 #4 ROPE

SHP9343 #5 ROPE

SHP9344 #5.5 ROPE

SHP9345 #6 ROPE



SPRING LOADED BALL JOINTS

- Use to connect reels or rollers to each other
- Spring loaded quick connect fittings
- Made to exceed oem specifications

SHP99-1460 FEMALE

SHP94-2958 MALE STUD



MOWER ROTARY BLADES

Our full line of mower blades cover everything from walk behind mowers to large rough units. Order based off of OEM part number, machine type or measurements.

STANDARD LIFT BLADES



MULCHING BLADES



| PAR WEST PART # | OEM PART # | LENGTH | ARBOR | BLADE TYPE | MACHINE |
|-----------------|-------------|-----------|-------|------------|--|
| ORE96-811 | GC00344 | 20 3/4" | 3/8" | MULCHING | JOHN DEERE 8800, 3425 SERIES |
| ORE396-710 | M144935 | 21 7/8" | 7/8" | MULCHING | JOHN DEERE |
| ORE396-743 | TCU15882 | 24 15/16" | 7/8" | MULCHING | JOHN DEERE 1453 |
| ORE396-770 | M142514 | 24 7/8" | 7/8" | MULCHING | JOHN DEERE 1453 |
| ORE396-770 | TCU14939 | 17 1/16" | 7/8" | MULCHING | JOHN DEERE 48" |
| ORE91-079 | TCU14939 | 17 1/16" | 7/8" | STANDARD | JOHN DEERE 48" |
| ORE596-769 | M136195 | 19 1/16" | 7/8" | MULCHING | JOHN DEERE 54" |
| ORE96-741 | 107-0235 | 26 15/16" | 1/2" | MULCHING | TORO 3500D/4000D/4500D/4700D |
| ORE94-045 | 92-5608-03 | 21 11/16" | 1/2" | STANDARD | TORO 4000D/4100D/4110D |
| ORE96-708 | 107-0214-03 | 21 11/16" | 1/2" | MULCHING | TORO 4000D/4100D/4110D |
| ORE96-701 | 106-7166 | 19 | 1/2" | MULCHING | TORO 455D |
| ORE94-011 | 29-5530 | 25" | 3/4" | STANDARD | TORO 72" LEFT HAND CUT GROUNDMASTER |
| ORE94-074 | 110-0621-03 | 24.5" | 1/2" | STANDARD | TORO GROUNDMASTER 3280- 3320 |
| ORE96-802 | 110-5948-03 | 20" | 1/2" | MULCHING | TORO GROUNDMASTER 5900/5910 |
| ORE94-071 | 110-0624-03 | 24.5" | 1/2" | MULCHING | TORO GROUNDMASTER 3280D - 72" CUT |
| ORE396-764 | 105-7711-03 | 24.5" | 5/8" | MULCHING | TORO TURBO FORCE DECK - 72" CUT |
| ORE396-726 | 390665 | 18" | 5/8" | MULCHING | JACOBSEN 52" CUT FOR RANSOMES |
| ORE396-702 | 112243-03 | 21" | 5/8" | MULCHING | JACOBSEN AR-5 |
| ORE93-025 | 112111-04 | 24 15/16" | 5/8" | STANDARD | JACOBSEN BOBCAT |
| ORE396-731 | 42139B/P848 | 25" | 5/8" | MULCHING | JACOBSEN BOBCAT/ LASTEC |
| ORE96-696 | JT391039 | 23" | 1/2" | MULCHING | JACOBSEN HR 5111 (LEFT HAND) |
| ORE96-795 | JT391040 | 23" | 1/2" | MULCHING | JACOBSEN HR 5111 (RIGHT HAND) |
| ORE92-013 | 3007759 | 20 13/16" | 1/2" | STANDARD | JACOBSEN HR 9016 |
| ORE93-013 | 112243-03 | 21" | 5/8" | STANDARD | JACOBSEN HR 6010/ TURFCAT 628D |

JOHN DEERE ROTARY MOWERS

TORO ROTARY MOWERS

JACOBSEN ROTARY MOWERS

Don't see the blade you're looking for? We have dozens more - call us for more options!

214 EQUIPMENT PARTS

The Ultra Blade is engineered for the professional turfgrass manager who is serious about achieving the highest quality of cut possible with a rotary mower.

ULTRA BLADES CAN BE MANUFACTURED TO FIT MOST ROTARY MOWERS!

ULTRA BLADE

Ultra Premium Rotary Mower Blades

- Manufactured from high chrome / nickel alloy
- Specifically heat treated and polished for maximum performance and longevity
- When re-sharpening is necessary, just one to two passes along the cutting edge restores the blade to its original razor sharp edge
- **NOTE- Add OEM part # for your blade choice**



TP-"OEM#"-U

MAGNA-MATIC ROTARY BLADE SHARPENING SYSTEMS



8100 SERIES PROFESSIONAL WORKSTATION

System 1



MAG-8100 Sharpener
MAG-1000 Blade Balancer
MAG-10400 Service Center Stand
Instruction Manual

SHPMAG-SYSTEM1

8100 SERIES PROFESSIONAL WORKSTATION

System 2



MAG-8100 Sharpener
MAG-1000 Blade Balancer
MAG-10400 Service Center Stand
MAG-200 Dust Collector (with stand bracket kit)
Instruction Manual

SHPMAG-SYSTEM2

8200M SERIES PROFESSIONAL WORKSTATION

SYSTEM 4



MAG-8200M Blade Sharpener
MAG-1000 Blade Balancer
MAG-10400 Service Center Stand
Instruction Manual

SHPMAG-SYSTEM4

8200M SERIES PROFESSIONAL WORKSTATION

SYSTEM 5



MAG-8200M Blade Sharpener
MAG-1000 Blade Balancer
MAG-10400 Service Center Stand
MAG-200 Dust Collector (with stand bracket kit)
Instruction Manual

SHPMAG-SYSTEM5

SHARPENER STAND

Add On to Sharpener



SHPMAG-10400

MAG-8100 LAWN MOWER BLADE SHARPENER, 1/2HP

Rotary Blade Sharpener



SHPMAG-8100

MAG-8200M LAWN MOWER BLADE SHARPENER, 1 HP

Rotary Blade Sharpener



SHPMAG-8200M

NO PORT FOR DUST COLLECTOR

SHPMAG-8200M-DCP

4" PORT FOR DUST COLLECTOR

DUST COLLECTOR

Add On To Sharpener



SHPMAG-200

MAGNA-MATIC ROTARY BLADE BALANCER



SHPMAG-1000

ROTARY BLADE BALANCE



SHPBB

Pricing is subject to change.

LAPPING COMPOUND



- PHL50** 50 GRIT
- PHL80** 80 GRIT
- PHL100** 100 GRIT
- PHL120** 120 GRIT
- PHL150** 150 GRIT
- PHL180** 180 GRIT
- PHL220** 220 GRIT

- Premixed, 25 pound pail
- Formulated with quality minerals and water soluble gel
- Easily rinsed off with water
- All popular grit sizes - from 50 to 220 also available in dry

BACK LAPPING BRUSH



SHPBLB

BACK LAPPING MACHINE



- 1/2 HP reversing motor
- Two adjustable support stands

SHPBL

BEDKNIFE IMPACT DRIVER



- Use with drive bits below
- Converts hammer impacts into 200 ft. lbs. of torque
- Impact helps keep bits in their grooves

SHPID

ANTI SEIZE



SHP11432

SPRING LOADED BALL JOINTS

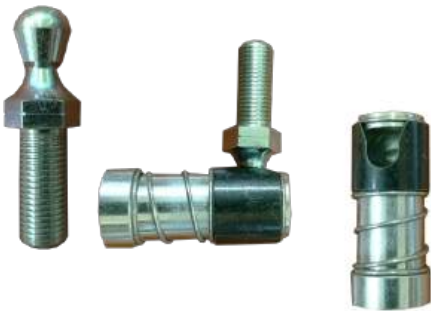

- Use to connect reels or rollers to each other
- Spring loaded quick connect fittings
- Made to exceed oem specifications

- SHP99-1460** FEMALE
- SHP94-2958** MALE STUD

IMPACT SCREW BIT FOR BEDKNIVES

- Use with driver above or mount on impact gun
- Specially made to fit Toro, John Deere or Jacobsen bedknife screws



- SHP4S-D101** JOHN DEERE
- SHP4S-T101** TORO
- SHP4S-J101** JACOBSEN GREENS MOWERS
- SHP4S-J102** JACOBSEN FAIRWAY MOWERS

VERTICUT-GAGE



ACU015-VC HOC GAGE W/ DIGITAL GAGE

- Precision measuring instrument for accurately setting the desired depth on verticutter units
- Both above grade and below grade measurements are possible.
- Adjustment bracket for centering the indicator block.
- Gage reads toward user for easy adjusting.
- Fits most verticutter units.

ACCU-GAUGE

- Adjustments can be made with the height of cut gauge on the mower. Simply read the gauge while turning the adjusting knob.
- Measurements are made at the front edge of the bedknife regardless of bedknife wear.
- Front and rear roller defects can be measured as well as bedknife defects.
- Fits all makes of Greensmowers, both riders & walkers.
- Works on both grooved and solid rollers.
- Available in dial gauge, digital gauge or metric dial gauge
- Several accessory variations are available

18 INCH MODELS

| | |
|------------------|------------------------------------|
| ACU001-18 | DIAL GAUGE - NO EXTRAS |
| ACU001-18-HF | DIAL W/ HANDS FREE |
| ACU001-18-GG | DIAL W/ GAUGE GUARD |
| ACU001-18-GRG | DIAL W/ GRIP GUARD |
| ACU001-18-HF-GR | DIAL W/ GRIP GUARD & HANDS FREE |
| ACU001-18D | DIGITAL GAUGE - NO EXTRAS |
| ACU001-18D-HF | DIGITAL W/ HANDS FREE |
| ACU001-18D-GG | DIGITAL W/ GAUGE GUARD |
| ACU001-18D-GRG | DIGITAL W/ GRIP GUARD |
| ACU001-18D-HF-GR | DIGITAL W/ GRIP GUARD & HANDS FREE |

24 INCH MODELS

| | |
|------------------|------------------------------------|
| ACU001-24 | DIAL GAUGE - NO EXTRAS |
| ACU001-24-HF | DIAL W/ HANDS FREE |
| ACU001-24-GG | DIAL W/ GAUGE GUARD |
| ACU001-24-GRG | DIAL W/ GRIP GUARD |
| ACU001-24-HF-GR | DIAL W/ GRIP GUARD & HANDS FREE |
| ACU001-24D | DIGITAL GAUGE - NO EXTRAS |
| ACU001-24D-HF | DIGITAL W/ HANDS FREE |
| ACU001-24D-GG | DIGITAL W/ GAUGE GUARD |
| ACU001-24D-GRG | DIGITAL W/ GRIP GUARD |
| ACU001-24D-HF-GR | DIGITAL W/ GRIP GUARD & HANDS FREE |



DIAL GAUGE



DIGITAL GAUGE



HANDS FREE



GAUGE GUARD



GRIP GUARD

ALUMINUM CASE FOR ACCU-GAGE



ACU001-AC

GROOMER-GAGE



| | |
|------------|-----------------------|
| ACU007 | DIAL GAUGE |
| ACU007D | DIGITAL GAUGE |
| ACU007-HF | DIAL W/ HANDS FREE |
| ACU007D-HF | DIGITAL W/ HANDS FREE |

- Groomer-Gage is a precision measuring instrument for accurately setting the desired grooming depth of groomer or verticutting units.
- Bar length - 18"
- Easy to use, just set the bar on the front and rear rollers and, with the grooming blades rotated perpendicular to the bar, push the indicating rod up until the indicating block touches the blades. Read Gage for measurement.

Pricing is subject to change.

BENCH PLATES



- A useful utility surface plate, with an attached parallel bar for use in setting mower rear rollers parallel with the reel.

ACU006A 20" X 36" BENCH PLATE
ACU006B 18" X 24" BENCH PLATE

ROLLER CHECK



- Easy to use tool for checking the parallelness of rear rollers on Greensmowers

ACURC-II GREENSMOWER - 22"
ACURC-III FAIRWAY MOWER - 30"

ANGLE CHECK



- Check your bedknife attitude with the new ANGLE-CHECK
- Digital and magnetic, the ANGLE-CHECK is the easy way to check your bedknife attitude.

ACU001-AG ANGLE CHECK

BEDKNIFE FACER



- High performance angle grinder with a customized angle attachment to facilitate in front edge bedknife grinding (also called facing)
- Adjustable pin moves the reel in front of the grinding disc
- Makita-Built motor delivers 10,000 RPMS
- Choose standard, variable speed or cordless options

ACUMFG-1A FAST GRIND
ACUMFG-4A VARIABLE SPEED
ACUMFG-2C 18 VOLT CORDLESS

BEDKNIFE BUDDY



- The Bedknife buddy is a quick and easy way to lightly "touch up" Greensmower bedknives
- Unique nylon holding block moves the reel out of the way while the file (replaceable) puts a light clean up edge on the front face of the bedknife.



ACUBB-01 BEDKNIFE BUDDY

ACCUGAUGE II W/ CASE



- The Accu-Gage II is for ease in checking or setting mowers in the field or while units are still attached to mowers.
- (Available in digital only)
- Easy to use. Place under mower with indicator head bedkife and read gage.
- Comes with case

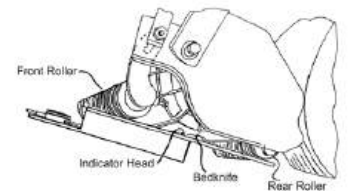

ACU001-IID DIGITAL GAUGE

BEDKNIFE SCREWS



CTI32-4910 TORO BEDKNIFE SCREWS (PACK 100)
CTI30-7194 JOHN DEERE BEDKNIFE SCREWS (PACK 100)
CTI30-5055 JOHN DEERE BEDKNIFE SCREWS W/ NUTS (PACK 25)
CTI31-9138 JACOBSEN BEDKNIFE SCREWS (PACK 100)

PRO EDGE III BEDKNIFE SHARPENER



- Sharpens top face and front edge
- Bed knife held in place with two modified mechanical "C" clamps
- All-electric motor
- Special composite stone grinds without creating excess heat
- Fully automatic (optional)
- All aluminum

TPBS-PE3

218 EQUIPMENT PARTS

PREMIUM BEDKNIVES

| DESCRIPTION | PART # | HOLES | MIN. CUT | OEM # | MODELS |
|---------------------------------|------------|-------|----------|--------------------|---|
| 18" MICRO CUT | CTI32-261 | 11 | .115" | 98-7261 | GM1800/FLEX 18/ EFLEX 1800 |
| 21" HIGH CUT | CTI32-396 | 7 | .135" | 94-6396 | GM3000 |
| PHOENIX 13 HOLE SUPER MICRO CUT | CTI32P-261 | 13 | .098" | N/A | |
| PHOENIX 13 HOLE MICRO CUT 21.5" | CTI32P-262 | 13 | .098" | 93-4262 | |
| 21" MICRO CUT | CTI32-262 | 13 | .115" | 93-4262 | |
| PHOENIX TOURN. 21.5" | CTI32P-263 | 13 | .115" | 93-4263 | |
| 21" TOURN. | CTI32-263 | 13 | .125" | 93-4263 | |
| 21" LOW CUT | CTI32-264 | 13 | .135" | 93-4264 | |
| 26" LOW CUT | CTI32-015 | 16 | .125" | 93-9015 | GM1600, GM2600 |
| 21" FAIRWAY CUT | CTI32-610 | 7 | .250" | 63-8610 | RM223D, 5100D, 5200D, 5300D, 5400D |
| 21" HIGH CUT HEAVY DUTY | CTI32-350 | 7 | .375" | 100-3350 | RM223D, 5100D, 5200D, 5300D, 5400D |
| 22" FAIRWAY CUT | CTI32-096 | 8 | .375" | 108-9096 | RM5210, 5410, 5510, 5610, 5500D, 6500D, 6700D |
| 30" FAIRWAY CUT | CTI32-890 | 10 | .375" | 72-0480 59-5890 | RM335, 3500D, 450D, 4000D, 4500D |
| 32" LOW CUT | CTI32-079 | 12 | .375" | 94-5079 | RM216, 2000D, 2300D, 2600D, 3100D |
| PHOENIX 22" SUPER TOURNAMENT | | 13 | .098" | ET4869 | |
| PHOENIX SUPER MICRO | CTI30P-351 | 13 | .098" | MT7351 | 220 A/B/C/SI walk behind Greensmower, 2243 & 2500 pro |
| PHOENIX TOURN. | CTI30P-534 | 13 | .115" | ET17534 | Greensmower, 3215a & 3235A lightweight fwy mower, 7500 & 8500 fairway mower |
| 22" TOURNAMENT | CTI30-534 | 13 | .115" | ET17534 | |
| 22" STANDARD | CTI30-533 | 13 | .125" | ET17533 | |
| 22" FWY LOW CUT | CTI30-532 | 13 | .135" | ET17532 | 3215A, 3235A, 3225C, 7700, 8700 fwy mowers |
| 22" FWY HIGH CUT | CTI30-767 | 13 | .275" | ET17767 | |
| 22" STANDARD | CTI30-751 | 9 | .375" | ET17751 | |
| 26" STANDARD | CTI30-947 | 15 | .125" | MT6947 | A/B/C WALK BEHIND GREENSMOWERS |
| 26" FAIRWAY | CTI30-946 | 15 | .189" | MT6946 | |
| 26" STANDARD FWY | CTI30-752 | 10 | .375" | ET17752 | 2653 (A) |
| 18" MEDIUM | CTI31-902 | 11 | .250" | 4118902 | |
| 18" SUPER TOURN. | CTI31-888 | 11 | .125" | 5002888 | |
| 19" TOURNAMENT | CTI31-476 | 11 | .125" | 503476 | PGM 19 |
| 19" SUPER TOURN. | CTI31-984 | 11 | .115" | 2810984 | PGM 19 |
| 22" PHOENIX SUPER TOURN. | CTI31P-887 | 13 | .098" | 5002887 | |
| 22" SUPER TOURN. | CTI31-887 | 13 | .115" | 5002887 | |
| 22" PHOENIX TOURN. | CTI31P-479 | 13 | .115" | 53479 | |
| 22" TOURNAMENT | CTI31-479 | 13 | .125" | 503479 | |
| 22" LOW PROFILE | CTI31-478 | 13 | .135" | 503478 | |
| 22" HIGH PROFILE | CTI31-477 | 13 | .175" | 503477 | |
| 22" HEAVY SECTION | CTI31-460 | 13 | .325" | 503460 | FAIRWAY MOWERS |

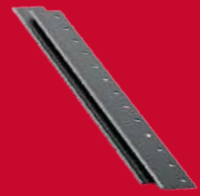

TORO BEDKNIVES



JOHN DEERE BEDKNIVES



JACOBSEN BEDKNIVES

Pricing is subject to change.

Eclipse 122/122f, pgm22, gk522, e-walk, gkv, eclipse 322, gkv, gkvi, gp400, g-plexiii

PREMIUM BEDKNIVES

- We source bedKnives that are available in multiple thicknesses and are available to fit major brand Greens, tees and fairway mowers.
- Material: Spring type steel high carbon content, with chrome/nickel alloys. Polish finish.
- Straightness: our bedknives are guaranteed to be perfectly straight without the need for grinding after attaching.
- We are now making a 30 – 40 degree "Manufactured Relief" standard on many of our bedknives.

| PART # | | DESCRIPTION |
|--------------|---------|---|
| TP-14402 | ET14402 | JOHN DEERE / 1/8" CUT / STANDARD BEDKNIFE |
| TP-14402-U | ET14402 | JOHN DEERE STANDARD 1/8" CUT / ULTRA QUALITY BEDKNIFE |
| TP-17532 | ET17532 | JOHN DEERE / 2500 / MEDIUM DUTY BEDKNIFE |
| TP-17533 | ET17533 | JOHN DEERE / 22" / 13 HOLE / 1/8" CUT STANDARD BEDKNIFE |
| TP-17533-U | ET17533 | JOHN DEERE / 22" / 13 HOLE / 1/8" / ULTRA QUALITY BEDKNIFE |
| TP-17534 | ET17534 | JOHN DEERE / 22" / 13 HOLE / 1/16" CUT BEDKNIFE |
| TP-17534-U | ET17534 | JOHN DEERE / 22" / 13 HOLE / 1/16" / ULTRA QUALITY BEDKNIFE |
| TP-17751 | ET17751 | JOHN DEERE / 3215 A / 9 HOLE / HEAVY CUTTING BEDKNIFE |
| TP-17752 | ET17752 | JOHN DEERE / 2653 / 26" BEDKNIFE |
| TP-17767 | ET17767 | JOHN DEERE / 3215 / 13 HOLE / MEDIUM CUTTING BEDKNIFE |
| TP-1973 | ET1973 | JOHN DEERE / 30" / 12 HOLE BEDKNIFE |
| TP-476680 | 47-6680 | TORO SPARTAN / LOW CUT / SINGLE LIP BEDKNIFE |
| TP-497660 | 49-7660 | TORO REEL MASTER / HEAVY CUT BEDKNIFE |
| TP-625180 | 62-5180 | TORO GM / 21" / 13 HOLE / 5/16" CUT BEDKNIFE |
| TP-638610 | 63-8610 | TORO GM / 21" / 7 HOLE / 1/4" CUT BEDKNIFE |
| TP-934262-U | 93-4262 | TORO GM / 21" / 13 HOLE / MICRO / ULTRA QUALITY BEDKNIFE |
| TP-934264 | 93-4263 | TORO GM / 21" / 13 HOLE / 3/32" CUT BEDKNIFE |
| TP-934264-U | 93-4264 | TORO GM / 21" / 13 HOLE / 1/8" CUT /ULTRA QUALITY BEDKNIFE |
| TP-945079 | 94-5079 | TORO 2600 / 3100 |
| TP-946392 | 94-6392 | TORO GM / 21" / 13 HOLE / 3/16" CUT BEDKNIFE |
| TP-948936 | 94-8936 | TORO 5500 / 6500 |
| TP-325163 | 325163 | JACOBSEN FAIRWAY / 1/2" CUT BEDKNIFE |
| TP-4128286-U | 4128286 | JACOBSEN SUPER TOURNAMENT BEDKNIFE |
| TP-5003150 | 5003150 | JACOBSEN LIGHTWEIGHT FAIRWAY / LOW CUT BEDKNIFE |
| TP-503363 | 503363 | JACOBSEN TRI KING / 30" BEDKNIFE |
| TP-503460 | 503460 | JACOBSEN LIGHTWEIGHT FAIRWAY BEDKNIFE |
| TP-503477 | 503477 | JACOBSEN / 22" / 3/16" CUT BEDKNIFE |
| TP-503478 | 503478 | JACOBSEN / 22" / 1/8" CUT BEDKNIFE |
| TP-503478-U | 503478 | JACOBSEN / 22" / 1/8" CUT / ULTRA QUALITY BEDKNIFE |
| TP-503479-U | 503479 | JACOBSEN / 22" / 3/32" CUT / ULTRA QUALITY BEDKNIFE |
| TP-503654 | 503654 | JACOBSEN 3810 / 26" BEDKNIFE |
| TP-554284 | 554284 | JACOBSEN TRI KING / 26" BEDKNIFE |



JOHN DEERE BEDKNIVES



TORO BEDKNIVES



JACOBSEN BEDKNIVES

220 EQUIPMENT PARTS

PREMIUM REPLACEMENT CUTTING REELS

Toro Mowers

Our reels feature the quality you have come to expect with our tines and bedknives with a price that beats oem parts



- Longer life from quality materials
- No preparation - install and mow
- Superior fit and finish

| PART # | OEM # | SIZE | BLADES | FITS MOWERS |
|-------------|---|----------|----------|---|
| CTI32-R6097 | 93-6097, 127-2182, 132-7313 (EDGE SERIES) | 5" X 21" | 11 BLADE | GREENSMASER 1000, 1010, AND 2000 INTERGRAL CUTTING UNITS |
| CTI32-R7635 | 107-7635, 127-2176 | 5" X 21" | 11 BLADE | GREENSMASER FLEX 21 (2011 AND OLDER) |
| CTI32-R4289 | 115-4289, 127-2177 | 5" X 21" | 14 BLADE | GREENSMASER FLEX 21 (2011 AND OLDER) |
| CTI32-R4104 | 119-4104, 127-2201, 137-8512 (EDGE SERIES REEL) | 5" X 21" | 11 BLADE | GREENSMASER FLEX / EFLEX 2100 AND 2120 (2012 AND NEWER) |
| CTI32-R4105 | 119-4105, 127-2202, 137-8513 (EDGE SERIES REEL) | 5" X 21" | 14 BLADE | GREENSMASER FLEX / EFLEX 2100 AND 2120 (2012 AND NEWER) |
| CTI32-R5792 | 105-5792, 127-2194 | 5" X 21" | 11 BLADE | GREENSMASER 3000, 3100, AND 3200 DPA CUTTING UNITS (2011 AND OLDER) |
| CTI32-R0649 | 14-0649, 130-0093 | 5" X 21" | 8 BLADE | REELMASTER 5200, 5300, AND 5400 4 BOLT CUTTING UNITS |
| CTI32-R9071 | 108-9071, 127-2065, 137-8416 (REEL) | 5" X 22" | 8 BLADE | REELMASTER 5210 AND 5410 DPA CUTTING UNITS |
| CTI32-R9073 | 108-9073, 127-2084, 137-8432 (REEL) | 7" X 22" | 8 BLADE | REELMASTER 5510, 5610, 6500, AND 6700 DPA CUTTING UNITS |
| CTI32-R9074 | 108-9074, 127-2085, 137-8433 (REEL) | 7" X 22" | 11 BLADE | REELMASTER 5510, 5610, 6500, AND 6700 DPA CUTTING UNITS |
| CTI32-R4337 | 94-4337, 130-0095, 137-8451 (REEL) | 7" X 22" | 5 BLADE | REELMASTER 6500 AND 6700 SPA CUTTING UNITS |

PREMIUM REPLACEMENT CUTTING REELS

John Deere Mowers

Our reels feature the quality you have come to expect with our tines and bedknives with a price that beats oem parts



- Longer life form quality materials
- No prepration - install and mow
- Superior fit and finish

| PART # | OEM # | SIZE | BLADES | FITS MOWERS |
|-------------|----------|----------|----------|--|
| CTI30-R2883 | AMT2883 | 5" X 22" | 11 BLADE | 2243 AND 2500 PROFESSIONAL GREENSMOWER 3215A, 3235A, 7500, AND 8500 LIGHTWEIGHT FAIRWAY MOWER |
| CTI30-R2885 | AMT2885 | 5" X 22" | 11 BLADE | 2243 AND 2500 PROFESSIONAL GREENSMOWER 3215A, 3235A, 7500, AND 8500 LIGHTWEIGHT FAIRWAY MOWER |
| CTI30-R2886 | AMT2886 | 5" X 22" | 11 BLADE | 180A, 220, 220A WALK-BEHIND GREENSMOWER |
| CTI30-R9350 | TCA19350 | 5" X 22" | 7 BLADE | 220 E-CUT WALK-BEHIND GREENSMOWER, 2500B AND 2500E RIDING GREENSMOWER, 7500 AND 8500 FAIRWAY MOWER |

Pricing is subject to change.

PREMIUM REPLACEMENT CUTTING REELS

John Deere Mowers



| PART # | OEM # | SIZE | BLADES | FITS MOWERS |
|-------------|----------|----------|----------|--|
| CTI30-R9351 | TCA19351 | 5" X 22" | 11 BLADE | 220 E-CUT WALK-BEHIND GREENSMOWER, 2500B AND 2500E RIDING GREENSMOWER, 7500 AND 8500 FAIRWAY MOWER |
| CTI30-R3621 | TCA23621 | 5" X 22" | 14 BLADE | 220 E-CUT WALK-BEHIND GREENSMOWER, 2500B AND 2500E RIDING GREENSMOWER, 7500 AND 8500 FAIRWAY MOWER |
| CTI30-R2893 | AMT2893 | 7" X 22" | 8 BLADE | 3215A/ B, 3225B /C, 3235 A/B/C, 7700, AND 8700 LIGHTWEIGHT FAIRWAY MOWERS |
| CTI30-R2894 | AMT2894 | 7" X 22" | 10 BLADE | 3215A/ B, 3225B /C, 3235 A/B/C, 7700, AND 8700 LIGHTWEIGHT FAIRWAY MOWERS |
| CTI30-R9353 | TCA19353 | 7" X 22" | 8 BLADE | 7700 AND 8700 FAIRWAY MOWER |
| CTI30-R9354 | TCA19354 | 7" X 22" | 10 BLADE | 7700 AND 8700 FAIRWAY MOWER |
| CTI30-R2871 | AMT2871 | 7" X 26" | 8 BLADE | 2653, 2653A, AND 2653B PROFESSIONAL UTILITY MOWER |
| CTI30-R9356 | TCA19356 | 7" X 26" | 8 BLADE | 2653B AND 7200 TRIM AND SURROUNDS MOWER, 8900A LARGE AREA REEL MOWER |

PREMIUM REPLACEMENT CUTTING REELS

Jacobsen Mowers



| PART # | OEM # | SIZE | BLADES | FITS MOWERS |
|-------------|---------|----------|----------|---|
| CTI31-R3053 | 5003053 | 5" X 22" | 7 BLADE | ECLIPSE 322, GP400, G-PLEX, AND E-PLEX, LF-128 (LEFT), LF-3400 (LEFT), LF-4675 (LEFT), LF-510 (LEFT), LF-550 (LEFT), AND LF-550H (LEFT) |
| CTI31-R3054 | 5003054 | 5" X 22" | 7 BLADE | GK 5 AND GK 6 ELECTRIC, LF-128 (RIGHT), LF3400 (RIGHT), F-4675 (RIGHT), LF-510 (RIGHT), LF-550 (RIGHT), AND LF-550H (RIGHT) |
| CTI31-R3453 | 5003453 | 5" X 22" | 11 BLADE | ECLIPSE 322, GP400, G-PLEX, AND E-PLEX, LF-128 (LEFT), LF-3400 (LEFT), LF-4675 (LEFT), LF-510 (LEFT), LF-550 (LEFT), AND LF-550H (LEFT) |
| CTI31-R3454 | 5003454 | 5" X 22" | 11 BLADE | GK 5 AND GK 6 ELECTRIC, LF-128 (RIGHT), LF3400 (RIGHT), LF-4675 (RIGHT), LF-510 (RIGHT), LF-550 (RIGHT), AND LF-550H (RIGHT) |
| CTI31-R0148 | 5000148 | 5" X 22" | 11 BLADE | GK 500-22" |
| CTI31-R1101 | 5001101 | 5" X 22" | 11 BLADE | ECLIPSE 322, ECLIPSE 122F, GK 4 (LEFT), G-PLEX 3, E-PLEX, GP400 |
| CTI31-R1102 | 5001102 | 5" X 22" | 11 BLADE | GK 4 (RIGHT), GK 5 AND GK 6 |
| CTI31-R3652 | 5003652 | 5" X 26" | 7 BLADE | GK 500-26" |
| CTI31-R2087 | 5002087 | 7" X 26" | 7 BLADE | TR 3 26" (LEFT) AND TRI KING 26" (LEFT) |
| CTI31-R2088 | 5002088 | 7" X 26" | 7 BLADE | TR 3 26" (RIGHT) AND TRI KING 26" (RIGHT) |

REEL RACK

Can Hold Up To 6 Cutting Units



- Save time and labor costs when storing or transporting reels
- 24" W x 48" L x 66" H
- All steel construction
- Zinc plated
- 800 lb capacity
- Comes complete with casters



TP-RR-1000

POWER EDGE III REEL SHARPENER



- Quick reel set-up, no special tools, just "snap" it in place
- Sharpens reel without need to disassemble reel unit, leave rollers and bed knife in place
- Sharpens most greens, tees, light weight fairway and walk behind professional mowers
- Eliminates "impact" grinding associated with conventional reel grinders
- No stress to reel bearings, seals, shaft and frame
- All Aluminum frame
- All Electric

TP-RS-PE3





GOLFCO COMPETITION ROLLERS

Not all rollers are created equal. We believe Golfco competition rollers are the best in the market. Here are the reasons why:



4 SECTION SMOOTH ROLLER



URETHANE SMOOTH ROLLER



URETHANE GROOVED ROLLER



DOUBLE STUBBY ROLLER



STUBBY ROLLER

- Common overhaul kit for all rollers (bearings, seals and retainers are the same). Sealed ball bearings that last without the need for re-greasing
- No need to grease - no grease stains on greens
- Is silent running on all surfaces
- Is very shock absorbing and impact resistant
- Resists debris buildup (superior to any metallic materials)
- Diminishes transmigration of harmful elements such as disease or fungus
- Will not develop frost buildup

GOLFCO ROLLERS

Overhaul Kit - Fits Any Golfco Roller



GOLOHCOMP



GOLFCO ROLLERS

True Turf Greens Rollers

TRU-TURF SMOOTHING HEADS ROLLERS FOR RS48-11E, RB48-11A & TR7000C MACHINES

| | | |
|----------------------|--|--|
| GOLT2222S25C | 2.5" SMOOTH URETHANE CAST OVER HEAVY DUTY STEEL TUBING 22.45" | 22.45" BODY TO FIT RS48-11E & RB48-11A |
| GOLT3939S25C | 2.5" SMOOTH URETHANE CAST OVER HEAVY DUTY STEEL TUBING 39.5 | 39.5" BODY TO FIT GR39 |
| GOLT3939S25C2 | 2.5" SMOOTH URETHANE CAST OVER HEAVY DUTY STEEL 39.5" 2 BODIES | 39.5" BODY TOTAL |

TRU-TURF SMOOTHING HEADS ROLLERS FOR R52 MACHINES

| | | |
|---------------------|---|------------------------|
| GOLT1818S25C | 2.5" SMOOTH URETHANE CAST OVER HEAVY DUTY STEEL TUBING 18.45" | 18.45" BODY TO FIT R52 |
|---------------------|---|------------------------|

ROLLER TAMER

Rebuild True Turf Cutting Unit Rollers



- Allows anyone regardless of skill level to quickly, easily, and properly rebuild cutting unit rollers
- assist with most types of rollers presently and formerly manufactured for the turf industry including water-pump bearing style rollers, tapered roller bearing type, radial ball bearing type, gang mower, basket rollers and others.
- Purchase a Base Unit then add the kit that best suits your needs for make and model of rollers to service.
- All Tamer components are interchangeable between models
- **NOTE- Must buy base unit kit before branded kits**

TP-RT-500 BASE UNIT ROLLER TAMER KIT









TP-RT-504 TRU-TURF PRIMARY KIT

TP-RT-506 *WATER PUMP BEARING PULL KIT





Pricing is subject to change.



TORO ROTARY DECK ROLLERS

| PART # | DIA. | TYPE | FRONT / REAR | | OEM NUMBER | MOWERS |
|--------------|------|------------------|--------------|---|------------------------------|-----------------------------|
| GOLT0505G5C | 5" | URETHANE SMOOTH | FRONT |  | 104-1092, 115-3412, 115-3418 | 4500D, 4700D, 3500D & 3505D |
| GOLT3329A3CG | 3" | URETHANE GROOVED | REAR |  | | 4500D, 4700D, 3500D & 3505D |
| GOLT3329A3C | 3" | URETHANE SMOOTH | REAR |  | 112-5265 | 4500D, 4700D, 3500D & 3505D |
| GOLT3329A3S | 3" | STEEL SMOOTH | REAR |  | 112-5265 | 4500D, 4700D, 3500D & 3505D |
| GOLT0705G5C | 5" | URETHANE SMOOTH | FRONT |  | 115-3418, 114-0430 | 4300D |
| GOLT2824K3CG | 3" | URETHANE GROOVED | REAR |  | | 4300D |
| GOLT2824K3C | 3" | URETHANE SMOOTH | REAR |  | 108-7387 | 4300D |
| GOLT2824K3S | 3" | STEEL SMOOTH | REAR |  | 108-7387 | 4300D |

TORO SIDEWINDER ROLLERS

| PART # | DIA. | TYPE | FRONT / REAR | | OEM NUMBER | MOWERS |
|---------------|------|------------------|--------------|---|-------------------|----------------------------|
| GOLT3026D25CG | 2.5" | URETHANE | FRONT & REAR |  | 92-7410, 104-1385 | 27" 3100D, 27" 2300D & 216 |
| GOLT3026D25C | 2.5" | URETHANE SMOOTH | FRONT & REAR |  | 61-0410 | 27" 3100D, 27" 2300D & 216 |
| GOLT3227D25CG | 3" | URETHANE SMOOTH | FRONT & REAR |  | 114-9383 | 27" 3100D, 27" 2300D & 216 |
| GOLT3227D25C | 3" | URETHANE GROOVED | FRONT & REAR |  | 112-8915 | 27" 3100D, 27" 2300D & 216 |

ROLLER TAMER

Rebuild Toro Cutting Unit Rollers



- allows anyone regardless of skill level to quickly, easily, and properly rebuild cutting unit rollers
- assist with most types of rollers presently and formerly manufactured for the turf industry including water-pump bearing style rollers, tapered roller bearing type, radial ball bearing type, gang mower, basket rollers and others.
- Purchase a Base Unit then add the kit that best suits your needs for make and model of rollers to service.
- All Tamer components are interchangeable between models
- **NOTE- Must buy base unit kit before branded kits**



















TP-RT-500 BASE UNIT ROLLER TAMER KIT

TP-RT-502 TORO PRIMARY KIT

TP-RT-505 TORO GROUNDSMASTER KIT

TP-RT-506 *WATER PUMP BEARING PULL KIT

TORO GREEN & TEE MOWERS

| PART # | DIA. | TYPE | FRONT/ REAR | | MOWERS | OEM # OR SPECS |
|---------------|------|------------------|--------------|---|--|----------------------------|
| GOLT2522S2C | 2" | URETHANE SMOOTH | FRONT |  | 22" MOWERS - SERIES 1000, 3, 300, 3000, 3050, 3100, 3150 | 52-3170 |
| GOLT2522S2S | 2" | STEEL SMOOTH | FRONT |  | 22" MOWERS - SERIES 1000, 3, 300, 3000, 3050, 3100, 3150 | 52-3200 |
| GOLT2522S25CG | 2.5" | URETHANE GROOVED | FRONT |  | 22" MOWERS - SERIES 1000, 3, 300, 3000, 3050, 3100, 3150 | 22.5" BODY & 25.75" SHAFT |
| GOLT2522S25C | 2.5" | URETHANE SMOOTH | FRONT |  | 22" MOWERS - SERIES 1000, 3, 300, 3000, 3050, 3100, 3150 | 22.45" BODY & 25.75" SHAFT |
| GOLT2522A2C | 2" | URETHANE SMOOTH | REAR |  | 22" MOWERS - SERIES 1000, 3, 300, 3000, 3050, 3100, 3150 | 52-3120 |
| GOLT2522A2L | 2" | STEEL SMOOTH | REAR |  | 22" MOWERS - SERIES 1000, 3, 300, 3000, 3050, 3100, 3150 | 52-3120 |
| GOLT2522A25C | 2.5" | URETHANE SMOOTH | REAR |  | 22" MOWERS - SERIES 1000, 3, 300, 3000, 3050, 3100, 3150 | 22.45" BODY & 25.87" SHAFT |
| GOLT2522A2C | 2" | URETHANE SMOOTH | FRONT & REAR |  | 22" TRIFLEX - 3200, 3250, 3300, 3320, 3400, 3420 | 52-3120 |
| GOLT2522A2L | 2" | STEEL SMOOTH | FRONT & REAR |  | 22" TRIFLEX - 3200, 3250, 3300, 3320, 3400, 3420 | 52-3120 |
| GOLT2522A25CG | 2.5" | URETHANE GROOVED | FRONT & REAR |  | 22" TRIFLEX - 3200, 3250, 3300, 3320, 3400, 3420 | 22.25" BODY & 25.87" SHAFT |
| GOLT2522A25C | 2.5" | URETHANE SMOOTH | FRONT & REAR |  | 22" TRIFLEX - 3200, 3250, 3300, 3320, 3400, 3420 | 115-7388 |
| GOLT2522A25S | 2.5" | STEEL SMOOTH | FRONT & REAR |  | 22" TRIFLEX - 3200, 3250, 3300, 3320, 3400, 3420 | 115-7388 |
| GOLT2522A2C | 2" | URETHANE SMOOTH | FRONT & REAR |  | FLEX 21 & FLEX 2120 | 52-3120 |
| GOLT2522A2L | 2" | STEEL SMOOTH | FRONT & REAR |  | FLEX 21 & FLEX 2120 | 52-3120 |
| GOLT2219S2C | 2" | URETHANE SMOOTH | FRONT & REAR |  | GM800 18" | |
| GOLT3127A25CG | 2.5" | URETHANE GROOVED | FRONT & REAR |  | GM1600 26" | |
| GOLT3127A25C | 2.5" | URETHANE SMOOTH | FRONT & REAR |  | GM1600 26" | |
| GOLT3127A25S | 2.5" | STEEL SMOOTH | FRONT & REAR |  | GM1600 26" | |

ROLLER TAMER

Rebuild Toro Cutting Unit Rollers



- allows anyone regardless of skill level to quickly, easily, and properly rebuild cutting unit rollers
- assist with most types of rollers presently and formerly manufactured for the turf industry including water-pump bearing style rollers, tapered roller bearing type, radial ball bearing type, gang mower, basket rollers and others.
- Purchase a Base Unit then add the kit that best suits your needs for make and model of rollers to service.
- All Tamer components are interchangeable between models
- **NOTE- Must buy base unit kit this before branded kits**

TP-RT-500 BASE UNIT ROLLER TAMER KIT

























TP-RT-502 TORO PRIMARY KIT

TP-RT-505 TORO GROUNDSMASTER KIT

TP-RT-506 *WATER PUMP BEARING PULL KIT







Pricing is subject to change.

TORO FAIRWAY AND ROUGH REEL MOWERS











| PART # | DIA. | TYPE | FRONT/ REAR |  | MOWERS | OEM # OR SPECS |
|---------------|------|---------------------|-----------------|---|---|--|
| GOLT2722A3CG | 3" | URETHANE GROOVED | FRONT |  | 5200D, 5210D, 5400D, 5410D, 5510D & 5610D | 100-9906 |
| GOLT2722A3C | 3" | URETHANE SMOOTH | FRONT |  | 5200D, 5210D, 5400D, 5410D, 5510D & 5610D | 99-5749 |
| GOLT2724A3CG | 3" | URETHANE GROOVED | FRONT |  | 5200D, 5210D, 5400D, 5410D, 5510D & 5610D | 114-5400 |
| GOLT2724A3C | 3" | URETHANE SMOOTH | FRONT |  | 5200D, 5210D, 5400D, 5410D, 5510D & 5610D | 99-5749 |
| GOLT2522C3C | 3" | URETHANE SMOOTH | REAR |  | 5200D, 5210D, 5400D, 5410D, 5510D & 5610D | 22.45" BODY & 25.5" SHAFT |
| GOLT2522C3S | 3" | STEEL SMOOTH | REAR |  | 5200D, 5210D, 5400D, 5410D, 5510D & 5610D | 22.45" BODY & 25.5" SHAFT |
| GOLT2522C25C | 2.5" | URETHANE SMOOTH | REAR |  | 5200D, 5210D, 5400D, 5410D, 5510D & 5610D | 114-5406 |
| GOLT2522C25S | 2.5" | STEEL SMOOTH | REAR |  | 5200D, 5210D, 5400D, 5410D, 5510D & 5610D | 114-5406 |
| GOLT2321A2C | 2" | URETHANE SMOOTH | REAR |  | 5200D, 5210D, 5400D, 5410D, 5510D & 5610D | 21.25" BODY & 23.75" SHAFT |
| GOLT2321A2L | 2" | STEEL SMOOTH | REAR |  | 5200D, 5210D, 5400D, 5410D, 5510D & 5610D | 21.25" BODY & 23.75" SHAFT |
| GOLT2319A2C | 2" | URETHANE SMOOTH | REAR |  | 5200D, 5210D, 5400D, 5410D, 5510D & 5610D | 94-0694 |
| GOLT2319A2S | 2" | STEEL SMOOTH | REAR |  | 5200D, 5210D, 5400D, 5410D, 5510D & 5610D | 94-0694 |
| GOLT2722A3CG | 3" | URETHANE GROOVED | FRONT & REAR |  | 5500D, 6500D & 6700D | 100-9906 22.25" BODY & 27" SHAFT |
| GOLT2722A3C | 3" | URETHANE SMOOTH | FRONT & REAR |  | 5500D, 6500D & 6700D | 99-5749 22.25" BODY & 27" SHAFT |
| GOLT2722A3S | 3" | STEEL SMOOTH | FRONT & REAR |  | 5500D, 6500D & 6700D | 99-5749 22.25" BODY & 27" SHAFT |
| GOLT2724A3CG | 3" | URETHANE GROOVED | FRONT & REAR |  | 5500D, 6500D & 6700D | 114-5400 24.25" BODY & 27" SHAFT |
| GOLT2724A3C | 3" | URETHANE SMOOTH | FRONT & REAR |  | 5500D, 6500D & 6700D | 99-5749 24.25" BODY & 27" SHAFT |
| GOLT2724A3S | 3" | STEEL SMOOTH | FRONT & REAR |  | 5500D, 6500D & 6700D | 99-5749 24.25" BODY & 27" SHAFT |
| GOLT2522A25CG | 2.5" | URETHANE GROOVED | FRONT |  | 5100D, 5300D & 223D | 75-1520 |
| GOLT2319A2C | 2" | URETHANE SMOOTH | REAR |  | 5100D, 5300D & 223D | 94-0694 |
| GOLT2319A2S | 2" | STEEL SMOOTH | REAR |  | 5100D, 5300D & 223D | 94-0694 |
| GOLT3732K3CG | 3" | URETHANE GROOVED | FRONT |  | 4500D, 4300D, 4000D, 3500D, 450D, 335D & 350D | FITS 36" OR 37" SHAFT |
| GOLT3229T3CG | 3" | URETHANE GROOVED | FRONT |  | 4500D, 4300D, 4000D, 3500D, 450D, 335D & 350D | FITS 32" SHAFT |
| GOLT3429K3C | 3" | URETHANE SMOOTH | REAR |  | 4500D, 4300D, 4000D, 3500D, 450D, 335D & 350D | 59-5630 |

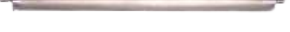

JOHN DEERE GREEN & TEE MOWERS





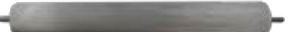









| PART # | DIA. | TYPE | FRONT/ REAR | | MOWERS | OEM # OR SPECS | |
|----------------------|------|------------------|--------------|---|--|-------------------------|--|
| GOLD2119A2CG | 2" | URETHANE GROOVED | FRONT |  | 18" 180B & 180C WALKING GREENSMOWERS | | |
| GOLD2119A2C | 2" | URETHANE SMOOTH | FRONT |  | 18" 180B & 180C WALKING GREENSMOWERS | | |
| GOLD2522C2CG | 2" | URETHANE GROOVED | FRONT & REAR |  | 22" 220 WALKING & 2243 RIDING GREENSMOWERS | 22.5" BODY, 25.5" SHAFT | |
| GOLD2522C2C | 2" | URETHANE SMOOTH | FRONT & REAR |  | 22" 220 WALKING & 2243 RIDING GREENSMOWERS | 22.5" BODY, 25.5" SHAFT | |
| GOLD2522C2CG | 2" | URETHANE GROOVED | FRONT & REAR |  | 22" 2500 GREENSMOWER | 22.5" BODY, 25.5" SHAFT | |
| GOLD2522C2C | 2" | URETHANE SMOOTH | FRONT & REAR |  | 22" 2500 GREENSMOWER | AMT2876 | |
| GOLD2926A25CG | 2.5" | URETHANE GROOVED | FRONT |  | 260SL WALKING GREENSMOWER | | |

JOHN DEERE FAIRWAY MOWERS

| PART # | DIA. | TYPE | FRONT/ REAR | | MOWERS | OEM # OR SPECS | |
|----------------------|------|------------------|--------------|---|---|--|--|
| GOLD2218A25CG | 2.5" | URETHANE GROOVED | FRONT & REAR |  | 18" 8000A PRECISION CUT & E-CUT FAIRWAY | 18.0" BODY, 22" SHAFT | |
| GOLD2218A25C | 2.5" | URETHANE SMOOTH | FRONT & REAR |  | 18" 8000A PRECISION CUT & E-CUT FAIRWAY | 18.0" BODY, 22" SHAFT | |
| GOLD2218A25S | 2.5" | STEEL SMOOTH | FRONT & REAR |  | 18" 8000A PRECISION CUT & E-CUT FAIRWAY | 18.0" BODY, 22" SHAFT | |
| GOLD2522C2CG | 2" | URETHANE GROOVED | FRONT & REAR |  | 22" 3215 & 3225 LIGHT FAIRWAY MOWERS | 22.5" BODY, 25.5" SHAFT | |
| GOLD2522C2C | 2" | URETHANE SMOOTH | FRONT & REAR |  | 22" 3215 & 3225 LIGHT FAIRWAY MOWERS | AMT2876 | |
| GOLD2522C2S | 2" | STEEL SMOOTH | FRONT & REAR |  | 22" 3215 & 3225 LIGHT FAIRWAY MOWERS | AMT2876 | |
| GOLD2522C3CG | 3" | URETHANE GROOVED | FRONT & REAR |  | 22" 3235 LIGHT FAIRWAY MOWER | 1 FLAT ON ONE END OF SHAFT | |
| GOLD2522C3C | 3" | URETHANE SMOOTH | FRONT & REAR |  | 22" 3235 LIGHT FAIRWAY MOWER | 1 FLAT ON ONE END OF SHAFT | |
| GOLD2522C3S | 3" | STEEL SMOOTH | FRONT & REAR |  | 22" 3235 LIGHT FAIRWAY MOWER | 1 FLAT ON ONE END OF SHAFT | |
| GOLD2522F3CG | 3" | URETHANE GROOVED | FRONT & REAR |  | 22" 3235 LIGHT FAIRWAY MOWER | 2 FLATS ON ONE END OF SHAFT | |
| GOLD2522F3C | 3" | URETHANE SMOOTH | FRONT & REAR |  | 22" 3235 LIGHT FAIRWAY MOWER | 2 FLATS ON ONE END OF SHAFT AMT2967 | |
| GOLD2522F3S | 3" | STEEL SMOOTH | FRONT & REAR |  | 22" 3235 LIGHT FAIRWAY MOWER | 2 FLATS ON ONE END OF SHAFT AMT2967 | |

Pricing is subject to change.

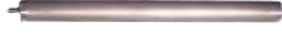
JOHN DEERE FAIRWAY & REEL ROUGH MOWERS

| PART # | DIA. | TYPE | FRONT/ REAR | | MOWERS | OEM # OR SPECS |
|--------------|------|---------------------|----------------|---|---|---|
| GOLD2522F3CG | 3" | URETHANE GROOVED | FRONT & REAR |  | 22" 7500/ 8500 & 7700/ 8700 PRECISION CUT & E-CUT | AMT2966, BM25317,BM17668 |
| GOLD2522F3C | 3" | URETHANE SMOOTH | FRONT & REAR |  | 22" 7500/ 8500 & 7700/ 8700 PRECISION CUT & E-CUT | 22.45" BODY, 25.5" SHAFT - 2 FLATS ON SHAFT |
| GOLD2522F3S | 3" | STEEL SMOOTH | FRONT & REAR |  | 22" 7500/ 8500 & 7700/ 8700 PRECISION CUT & E-CUT | 22.45" BODY, 25.5" SHAFT - 2 FLATS ON SHAFT |
| GOLD2522F2CG | 2" | URETHANE GROOVED | FRONT & REAR |  | 22" 7500/ 8500 & 7700/ 8700 PRECISION CUT & E-CUT | 22.5" BODY, 25.5" SHAFT 2 FLATS ON SHAFT |
| GOLD2522F2C | 2" | URETHANE SMOOTH | FRONT & REAR |  | 22" 7500/ 8500 & 7700/ 8700 PRECISION CUT & E-CUT | 22.5" BODY, 25.5" SHAFT 2 FLATS ON SHAFT |
| GOLD2522F2S | 2" | STEEL SMOOTH | FRONT & REAR |  | 22" 7500/ 8500 & 7700/ 8700 PRECISION CUT & E-CUT | 22.5" BODY, 25.5" SHAFT 2 FLATS ON SHAFT |
| GOLD2522C3CG | 3" | URETHANE GROOVED | FRONT & REAR |  | 22" 7500/ 8500 & 7700/ 8700 PRECISION CUT & E-CUT | 22.25" BODY, 25.5" SHAFT 1 FLAT ON SHAFT |
| GOLD2522C3C | 3" | URETHANE SMOOTH | FRONT & REAR |  | 22" 7500/ 8500 & 7700/ 8700 PRECISION CUT & E-CUT | 22.25" BODY, 25.5" SHAFT 1 FLAT ON SHAFT |
| GOLD2522C3S | 3" | STEEL SMOOTH | FRONT & REAR |  | 22" 7500/ 8500 & 7700/ 8700 PRECISION CUT & E-CUT | 22.25" BODY, 25.5" SHAFT 1 FLAT ON SHAFT |
| GOLD2522C2CG | 2" | URETHANE GROOVED | FRONT & REAR |  | 22" 7500/ 8500 & 7700/ 8700 PRECISION CUT & E-CUT | 22.25" BODY, 25.5" SHAFT 1 FLAT ON SHAFT |
| GOLD2522C2C | 2" | URETHANE SMOOTH | FRONT & REAR |  | 22" 7500/ 8500 & 7700/ 8700 PRECISION CUT & E-CUT | 22.25" BODY, 25.5" SHAFT 1 FLAT ON SHAFT |
| GOLD2522C2L | 2" | STEEL SMOOTH | FRONT & REAR |  | 22" 7500/ 8500 & 7700/ 8700 PRECISION CUT & E-CUT | 22.25" BODY, 25.5" SHAFT 1 FLAT ON SHAFT |
| GOLD3229X3CG | 3" | URETHANE GROOVED | FRONT & REAR |  | 30" FAIRWAY (305, 303, 756 & 856) | 32.25" SHAFT WITH .5" DIA. ENDS |
| GOLD3229X3C | 3" | URETHANE SMOOTH | FRONT & REAR |  | 30" FAIRWAY (305, 303, 756 & 856) | 32.25" SHAFT WITH .5" DIA. ENDS |
| GOLD3229X3S | 3" | STEEL SMOOTH | FRONT & REAR |  | 30" FAIRWAY (305, 303, 756 & 856) | 32.25" SHAFT WITH .5" DIA. ENDS |

ROLLER TAMER

Rebuild John Deere Cutting Unit Rollers



- allows anyone regardless of skill level to quickly, easily, and properly rebuild cutting unit rollers
- assist with most types of rollers presently and formerly manufactured for the turf industry including water-pump bearing style rollers, tapered roller bearing type, radial ball bearing type, gang mower, basket rollers and others.
- Purchase a Base Unit then add the kit that best suits your needs for make and model of rollers to service.
- All Tamer components are interchangeable between models
- **NOTE- Must buy base unit kit before branded kits**

TP-RT-500 BASE UNIT ROLLER TAMER KIT

TP-RT-503 JOHN DEERE PRIMARY KIT







TP-RT-504 TRU-TURF PRIMARY KIT

TP-RT-506 *WATER PUMP BEARING PULL KIT





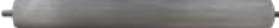



PARWEST.COM | 714-893-1555

 **PAR WEST**

JOHN DEERE ROTARY DECK ROLLERS

| PART # | DIA. | TYPE | FRONT / REAR | | OEM NUMBER | MOWERS |
|---------------------|------|------------------|--------------|---|-----------------------------|-----------------------|
| GOLD2926C3CG | 3" | URETHANE GROOVED | REAR |  | | 9009 7400A (2016+) |
| GOLD2926C3C | 3" | URETHANE SMOOTH | REAR |  | TCA17790 | 9009 7400A (2016+) |
| GOLD2926C3S | 3" | STEEL SMOOTH | REAR |  | | 9009 7400A (2016+) |
| GOLD0404G5C | 5" | URETHANE SMOOTH | FRONT |  | TCA19047, 19H3185 U44915 | 7400 (PRE 2016) |
| GOLD2925A3C | 3" | URETHANE SMOOTH | REAR |  | TCA17790 (3") TCA25970 | 7400 (PRE 2016) |
| GOLD2925A3S | 3" | STEEL SMOOTH | REAR |  | TCA17790 (3") TCA25970 | 7400 (PRE 2016) |
| GOLD2522C3C | 3" | URETHANE SMOOTH | REAR |  | | 2653 - 22" |
| GOLD3229N3C | 3" | URETHANE SMOOTH | REAR |  | | 2653 - 30" |













JACOBSEN ROTARY DECK ROLLERS

| PART # | DIA. | TYPE | FRONT / REAR | | OEM NUMBER | MOWERS |
|---------------------|------|-----------------|--------------|---|------------------------------|----------------------|
| GOLJ0404G5C | 5" | URETHANE SMOOTH | FRONT |  | | AR-522, AR-722, |
| GOLJ2926R3C | 3" | URETHANE SMOOTH | REAR |  | 4163121, 4124015 | AR-522, AR-722, AR-5 |
| GOLJ3004D3CT | 3" | URETHANE SMOOTH | REAR |  | | AR-5 |
| GOLJ3404R3CT | 3" | URETHANE SMOOTH | REAR |  | | AR-3 |
| GOLJ3429R3S | 3" | STEEL SMOOTH | REAR |  | 4163083, 4129612, 4163181 | AR-3 |
| GOLJ3429R3C | 3" | URETHANE SMOOTH | REAR |  | 4163083, 4129612, 4163181 | AR-3 |
| GOLR2722X4C | 3" | URETHANE SMOOTH | REAR |  | 4115430, 2206195 | AR-250, AR-2500 |
| GOLR2722X4S | 3" | STEEL SMOOTH | REAR |  | 4115430, 2206195 | AR-250, AR-2500 |

Although we have listed many of our most popular rollers here, there are dozens of other models. Please check our website or call us.

Pricing is subject to change.



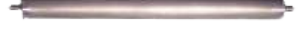















JACOBSEN GREENS & TEE MOWERS

| PART # | DIA. | TYPE | FRONT/REAR | | MOWERS | OEM # OR SPECS | PRICE |
|---------------|------|------------------|--------------|---|---|------------------------------|-------|
| GOLJ2522A2CG | 2" | URETHANE GROOVED | FRONT |  | 22" GK, GM, E-PLEX, G-PLEX & ECLIPSE 122 & 322 | 68527 | |
| GOLJ2522A2C | 2" | URETHANE SMOOTH | FRONT |  | 22" GK, GM, E-PLEX, G-PLEX & ECLIPSE 122 & 322 | 68641 | |
| GOLJ2522A25CG | 2.5" | URETHANE GROOVED | FRONT |  | 22" GK, GM, E-PLEX, G-PLEX & ECLIPSE 122 & 322 | 22.25" BODY & 25.87" SHAFT | |
| GOLJ2522A25C | 2.5" | URETHANE SMOOTH | FRONT |  | 22" GK, GM, E-PLEX, G-PLEX & ECLIPSE 122 & 322 | 22.45" BODY & 25.87" SHAFT | |
| GOLJ2422S2L | 2" | STEEL SMOOTH | REAR |  | 22" GK, GM, E-PLEX, G-PLEX & ECLIPSE 122 & 322 | 1004990 | |
| GOLJ2422S2C | 2" | URETHANE SMOOTH | REAR |  | 22" GK, GM, E-PLEX, G-PLEX & ECLIPSE 122 & 322 | 3/8"-24 TAPS IN SHAFT ENDS | |
| GOLJ2422G2L | 2" | STEEL SMOOTH | REAR |  | 22" GK, GM, E-PLEX, G-PLEX & ECLIPSE 122 & 322 | 7/16"-20 TAPS IN SHAFT ENDS | |
| GOLJ2422G2C | 2" | URETHANE SMOOTH | REAR |  | 22" GK, GM, E-PLEX, G-PLEX & ECLIPSE 122 & 322 | 7/16"-20 TAPS IN SHAFT ENDS | |
| GOLJ2119A2CG | 2" | URETHANE GROOVED | FRONT & REAR |  | ALL 18" GREENSMOWERS ECLIPSE 118, GK 418 & GK 518 | 68616, 63318 | |
| GOLJ2119A2C | 2" | URETHANE SMOOTH | FRONT & REAR |  | ALL 18" GREENSMOWERS ECLIPSE 118, GK 418 & GK 518 | 68626, 4108920, 4175221 | |
| GOLJ2119A2L | 2" | STEEL SMOOTH | FRONT & REAR |  | ALL 18" GREENSMOWERS ECLIPSE 118, GK 418 & GK 518 | 4108920, 4175221 | |
| GOLJ2119S2CG | 2" | URETHANE GROOVED | FRONT & REAR |  | 18" ECLIPSE2 118F | | |
| GOLJ2119S2C | 2" | URETHANE SMOOTH | FRONT & REAR |  | 18" ECLIPSE2 118F | 4175221 BODY + 4175220 SHAFT | |
| GOLJ2119S2L | 2" | STEEL SMOOTH | FRONT & REAR |  | 18" ECLIPSE2 118F | 4175221 BODY + 4175220 SHAFT | |

JACOBSEN TRI-KING TRIM MOWERS

| PART # | DIA. | TYPE | FRONT/REAR | | MOWERS | OEM # OR SPECS | |
|---------------|------|------------------|--------------|---|---------------------------|------------------|--|
| GOLJ3229A25CG | 2.5" | URETHANE GROOVED | FRONT & REAR |  | 30" TRIKING 1684D & 1900D | | |
| GOLJ3229A25C | 2.5" | URETHANE SMOOTH | FRONT & REAR |  | 30" TRIKING 1684D & 1900D | 132640 | |
| GOLJ3229A25S | 2.5" | STEEL SMOOTH | FRONT & REAR |  | 30" TRIKING 1684D & 1900D | 132640 | |
| GOLJ3229A3CG | 3" | URETHANE GROOVED | FRONT & REAR |  | 30" TRIKING 1684D & 1900D | 67729 (SET OF 3) | |
| GOLJ3229A3C | 3" | URETHANE SMOOTH | FRONT & REAR |  | 30" TRIKING 1684D & 1900D | | |
| GOLJ3229A3S | 3" | STEEL SMOOTH | FRONT & REAR |  | 30" TRIKING 1684D & 1900D | | |

JACOBSEN FAIRWAY MOWERS

| PART # | DIA. | TYPE | FRONT/REAR | | MOWERS | OEM # OR SPECS |
|--------------|------|------------------|--------------|---|--|---|
| GOLJ2522A3CG | 3" | URETHANE GROOVED | FRONT |  | ALL LF MODELS EXCEPT 26" 2500, 3050 & 3810 | 123268 |
| GOLJ2522A3C | 3" | URETHANE SMOOTH | FRONT |  | ALL LF MODELS EXCEPT 26" 2500, 3050 & 3810 | |
| GOLJ2422S2C | 2" | URETHANE SMOOTH | REAR |  | ALL LF MODELS EXCEPT 26" 2500, 3050 & 3810 | 22.25" BODY & 3/8"-24 TAPS IN SHAFT ENDS |
| GOLJ2422S2S | 2" | STEEL SMOOTH | REAR |  | ALL LF MODELS EXCEPT 26" 2500, 3050 & 3810 | 1000770 |
| GOLJ2422S2L | 2" | STEEL SMOOTH | REAR |  | ALL LF MODELS EXCEPT 26" 2500, 3050 & 3810 | 1004990 LIGHT TUBING |
| GOLJ2421S25C | 2.5" | URETHANE SMOOTH | REAR |  | ALL LF MODELS EXCEPT 26" 2500, 3050 & 3810 | 5003687, 1003728, 1002446, 100105 |
| GOLJ2421S25S | 2.5" | STEEL SMOOTH | REAR |  | ALL LF MODELS EXCEPT 26" 2500, 3050 & 3810 | 5003687, 1003728, 1002446, 100105 |
| GOLJ2422G2C | 2" | URETHANE SMOOTH | REAR |  | ALL LF MODELS EXCEPT 26" 2500, 3050 & 3810 | 22.25" BODY & 7/16"-20 TAPS IN SHAFT ENDS |
| GOLJ2422G2S | 2" | STEEL SMOOTH | REAR |  | ALL LF MODELS EXCEPT 26" 2500, 3050 & 3810 | 1000770 |
| GOLJ2422G2L | 2" | STEEL SMOOTH | REAR |  | ALL LF MODELS EXCEPT 26" 2500, 3050 & 3810 | 1004990 LIGHT TUBING |
| GOLJ2421G25C | 2.5" | URETHANE SMOOTH | REAR |  | ALL LF MODELS EXCEPT 26" 2500, 3050 & 3810 | 5003687, 1003728, 1002446, 100105 |
| GOLJ2421G25S | 2.5" | STEEL SMOOTH | REAR |  | ALL LF MODELS EXCEPT 26" 2500, 3050 & 3810 | 5003687, 1003728, 1002446, 100105 |
| GOLJ2419S2C | 2" | URETHANE SMOOTH | REAR |  | ALL LF MODELS EXCEPT 26" 2500, 3050 & 3810 | 19.25" BODY & 3/8"-24 TAPS IN SHAFT ENDS |
| GOLJ2419S2S | 2" | STEEL SMOOTH | REAR |  | ALL LF MODELS EXCEPT 26" 2500, 3050 & 3810 | 19.25" BODY & 3/8"-24 TAPS IN SHAFT ENDS |
| GOLJ3026X3CG | 3" | URETHANE GROOVED | FRONT & REAR |  | LF 2500 & LF 3050 | 1/2" DIA. SHAFT ENDS |
| GOLJ3026X3C | 3" | URETHANE SMOOTH | FRONT & REAR |  | LF 2500 & LF 3050 | 1/2" DIA. SHAFT ENDS |
| GOLJ2016G2C | 2" | URETHANE SMOOTH | REAR |  | 18" LIGHT FAIRWAY SLF1880 | 68674, 4115860 |
| GOLJ2019S2C | 2" | URETHANE SMOOTH | REAR |  | 18" LIGHT FAIRWAY SLF1880 | 4135083 |
| GOLJ2019S25C | 2.5" | URETHANE SMOOTH | REAR |  | 18" LIGHT FAIRWAY SLF1880 | 4135083 |

ROLLER TAMER

Rebuild Jacobsen Cutting Unit Rollers



- allows anyone regardless of skill level to quickly, easily, and properly rebuild cutting unit rollers
- assist with most types of rollers presently and formerly manufactured for the turf industry including water-pump bearing style rollers, tapered roller bearing type, radial ball bearing type, gang mower, basket rollers and others.
- Purchase a Base Unit then add the kit that best suits your needs for make and model of rollers to service.
- All Tamer components are interchangeable between models
- **NOTE- Must buy base unit kit before branded kits**

TP-RT-500 BASE UNIT ROLLER TAMER KIT

TP-RT-501 JACOBSEN PRIMARY KIT

TP-RT-504 TRU-TURF PRIMARY KIT

TP-RT-506 *WATER PUMP BEARING PULL KIT

Pricing is subject to change.

**TURF SAVER®**

With its classic square shouldered design, Turf Saver is the market leader for riding mowers. The flat profile and chevron tread provide excellent traction. The Turf-friendly design and breadth of line makes the Turf Saver tire versatile.



| PART # | BRAND | SIZE | PLY |
|-------------|------------|-----------------|-----|
| TIR5110251 | CARLSTAR | 410-4 | 2 |
| TIRDS7011 | DEESTONE | 4.10/3.5-4 | 4 |
| TIR5110271 | CARLSTAR | 11 X 4.00 - 4 | 2 |
| TIRDS7012 | DEESTONE | 11 X 4.00 - 4 | 4 |
| TIR5110111 | CARLSTAR | 9 X 3.50 - 4 | 4 |
| TIR5110101 | CARLSTAR | 11 X 4.00 - 4 | 2 |
| TIR5110211 | CARLSTAR | 13 X 5.00 - 6 | 4 |
| TIRDS7021 | DEESTONE | 13 X 5.00 - 6 | 4 |
| TIR5111861 | CARLSTAR | 13 X 6.50 - 6 | 4 |
| TIR5112501 | CARLSTAR | 15 X 6.00 - 6 | 4 |
| TIRDS7008 | DEESTONE | 15 X 6.00 - 6 | 4 |
| TIR51169900 | TRELLEBORG | 15 X 6.00 - 6 | 4 |
| TIR5110951 | CARLSTAR | 480/400-8 | 2 |
| TIR5110961 | CARLSTAR | 480/400-8 | 4 |
| TIR5112001 | CARLSTAR | 16 X 6.50 - 8 | 4 |
| TIRDS7031 | DEESTONE | 16 X 6.50 - 8 | 4 |
| TIRDS7035 | DEESTONE | 16 X 6.50 - 8 | 4 |
| TIR5110991 | CARLSTAR | 16 X 7.50 - 8 | 2 |
| TIR5110991 | CARLSTAR | 18 X 6.50 - 8 | 4 |
| TIR5111021 | CARLSTAR | 18 X 7.50 - 8 | 4 |
| TIR5110701 | CARLSTAR | 18 X 8.50 - 8 | 2 |
| TIR5110711 | CARLSTAR | 18 X 8.50 - 8 | 4 |
| TIRDS7039 | DEESTONE | 18 X 9.50 - 8 | 4 |
| TIR5110841 | CARLSTAR | 18 X 9.50 - 8 | 2 |
| TIR6L05011 | CARLSTAR | 18 X 9.50 - 8 | 4 |
| TIR511082 | CARLSTAR | 18 X 9.50 - 8 | 6 |
| TIR1004-917 | DEESTONE | 20 X 10.00 - 10 | 4 |
| TIR5111161 | CARLSTAR | 20 X 10.00 - 10 | 4 |
| TIRDS7043 | DEESTONE | 20 X 10.00 - 8 | 4 |
| TIR5111011 | CARLSTAR | 20 X 10.00 - 8 | 2 |
| TIR5111111 | CARLSTAR | 20 X 8.00 - 10 | 4 |
| TIRDS7041 | DEESTONE | 20 X 8.00 - 8 | 4 |
| TIR5110801 | CARLSTAR | 20 X 8.00 - 8 | 2 |
| TIR5111140 | CARLSTAR | 21 X 7.00 - 10 | 2 |
| TIR5110511 | CARLSTAR | 22 X 9.50 - 12 | 2 |
| TIR1214-917 | DEESTONE | 22 X 10.00 - 10 | 4 |
| TIR51112 | CARLSTAR | 23 X 10.50 - 12 | 2 |

INDUSTRIAL TIRES

- Radial Trail® HD - Radial Trailer tire offers increased tire life.
- Sport Trail® - Bias construction with a Radial look.
- Sport Trail LH - Perfect for boat, cargo, horse and stock, utility and specialty Trailers.
- USA Trail - Complete line of bias products for applications requiring durable performance

| PART # | BRAND | TIRE SIZE | PLY |
|------------------|----------|-------------|-----|
| TIR560375 | CARLSTAR | 10-16.5 | D |
| TIR3-50-001-7625 | WANDA | 10-16.5 | E |
| TIR112260 | GALAXY | 10-16.5 | E |
| TIR290260 | CONST | 10-16.5 | E |
| TIR570130 | CARLSTAR | 10-16.5 | E |
| TIR133260 | GALAXY | 10-16.5 | E |
| TIR6A0325 | CARLSTAR | 11L-15 | E |
| TIR544153 | GALAXY | 11L-15 | D |
| TIR51F3181 | CARLSTAR | 11L-15 | D |
| TIR231155 | GALAXY | 12.5/80-18 | E |
| TIR571291 | GALAXY | 12-16.5 | H |
| TIR3-50-001-7624 | WANDA | 12-16.5 | G |
| TIR112266 | GALAXY | 12-16.5 | F |
| TIR290266 | CONST | 12-16.5 | F |
| TIR133266 | GALAXY | 12-16.5 | F |
| TIR6A0326 | CARLSTAR | 14.9-24 | G |
| TIR245426 | GALAXY | 14.9-24 | |
| TIR200426 | GALAXY | 14-17.5 | F |
| TIR570077 | CARLSTAR | 14-17.5 | G |
| TIR6A0327 | CARLSTAR | 16.9-24 | G |
| TIR6A0363 | CARLSTAR | 16.9-24 | D |
| TIR200432 | GALAXY | 16.9-24 | F |
| TIR6A0800 | CARLSTAR | 16.9-28 | F |
| TIR200546 | GALAXY | 16.9-28 | e |
| TIR200548 | GALAXY | 17.5-24 | f |
| TIR6A034 | CARLSTAR | 17.5-24 | d |
| TIR200434 | GALAXY | 19.5-24 | e |
| TIRA0667 | CARLSTAR | 19.5-24 | d |
| TIR200439 | GALAXY | 19.5-24 | f |
| TIR6A0802 | CARLSTAR | 25x8.50-14 | f |
| TIR102103 | GALAXY | 43x16.00-20 | c |
| TIR570059 | CARLSTAR | 5.70-12 | c |
| TIR111026 | GALAXY | 9.51L-15 | b |
| TIR544143 | GALAXY | 9.51L-15 | d |
| TIR51F344 | CARLSTAR | 9.51L-15 | d |



232 EQUIPMENT PARTS



MULTI-TRAC C/S

The Turf Master / Multi-Trac C/S commercial grade tires feature our most durable tread compound with deep elements in a profile optimized for stability and traction.



| PART # | BRAND | SIZE | PLY |
|------------------|----------|------------------|-----|
| TIRP332188508 | WANDA | 18 X 8.50 - 8 | 4 |
| TIR5743311 | CARLSTAR | 18 X 8.50 - 8 | 4 |
| TIR574365 | CARLSTAR | 18 X 8.50 - 8 | 8 |
| TIR574399 | CARLSTAR | 18 X 9.50 - 10 | 6 |
| TIRP3322088 | WANDA | 20 X 8.00 - 8 | 4 |
| TIR574359 | CARLSTAR | 20 X 8.00 - 8 | 2 |
| TIRP332201008 | WANDA | 20 X 10.00 - 8 | 4 |
| TIR574341 | CARLSTAR | 20 X 10.00 - 8 | 4 |
| TIR5743U11 | CARLSTAR | 18 X 8.50 - 10 | 4 |
| TIR5.74E+54 | CARLSTAR | 18 X 10.50 - 10 | 4 |
| TIRP33220810 | WANDA | 20 X 8.00 - 10 | 6 |
| TIRP332201010 | WANDA | 20 X 10.00 - 10 | 4 |
| TIR574362 | CARLSTAR | 20 X 10.00 - 10 | 4 |
| TIR5743C2 | CARLSTAR | 20 X 10.00 - 10 | 6 |
| TIR94012459 | BKT | 20 X 10.00 - 10 | 6 |
| TIRP332221010 | CARLSTAR | 22 X 10.00 - 10 | 4 |
| TIRT221110007 | OTR | 22 X 11.00 - 10 | 4 |
| TIR574372 | CARLSTAR | 23 X 8.50 - 12 6 | 4 |
| TIR574329 | CARLSTAR | 23 X 9.50 - 12 4 | 4 |
| TIRP33223105012 | WANDA | 23 X 10.50 - 12 | 4 |
| TIR574353 | CARLSTAR | 23 X 10.50 - 12 | 6 |
| TIR574338 | CARLSTAR | 24 X 9.50 - 12 | 4 |
| TIRP332241212 | WANDA | 24 X 12.00 - 12 | 4 |
| TIRT241212004 | OTR | 24 X 12.00 - 12 | 4 |
| TIR574352 | CARLSTAR | 24 X 12.00 - 12 | 4 |
| TIRT241214002 | OTR | 24 X 12.00 - 14 | 4 |
| TIRT251212001 | OTR | 25 X 12.00 - 12 | 4 |
| TIR574369 | CARLSTAR | 25 X 11.00 - 12 | 4 |
| TIRP332261212 | WANDA | 26 X 12.00 - 12 | 4 |
| TIR5743611 | CARLSTAR | 26 X 12.00 - 12 | 4 |
| TIR3-50-001-2823 | WANDA | 26 X 12.00 - 12 | 4 |
| TIR5743771 | CARLSTAR | 26 X 12.00 - 12 | 6 |
| TIRT261412002 | OTR | 26 X 14.00 - 12 | 4 |
| TIR5743W7 | CARLSTAR | 26 X 14.00 - 12 | 4 |
| TIR574324 | CARLSTAR | 24 X 8.50 - 14 | 4 |
| TIRT80424120014 | OTR | 24 X 12.00 - 14 | 4 |
| TIR574371 | CARLSTAR | 25 X 8.50 - 14 | 6 |

PART

BRAND

SIZE

PLY

| | | | |
|-------------------|----------|-----------------|----|
| TIR574348 | CARLSTAR | 27 X 8.50 - 15 | 4 |
| TIR574356 | CARLSTAR | 27 X 8.50 - 15 | 6 |
| TIR5743H6 | CARLSTAR | 27 X 10.50 - 15 | 4 |
| TIR560454 | CARLSTAR | 29 X 12.50 - 15 | 6 |
| TIR560478 | CARLSTAR | 29 X 12.50 - 15 | 10 |
| TIR560362 | CARLSTAR | 31 X 13.50 - 15 | 4 |
| TIRT8042612006FP | OTR | 26 X 12.00 - 16 | 4 |
| TIRP3-50-001-9897 | WANDA | 41 X 14.00 - 20 | 4 |
| TIR570083 | CARLSTAR | 41 X 14.00 - 20 | 4 |
| TIR6A0375 | CARLSTAR | 44 X 18.00 - 20 | 6 |

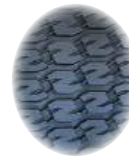

TURF TRAC RS

Turf Trac R/S offers all-around performance with a balanced profile and ample tread depth. Applications include grounds care equipment, zero turn mowers and utility vehicles.

PART

BRAND

SIZE

PLY

| | | | |
|-----------------|----------|--------------|---|
| TIR5753331 | CARLISLE | 11X4.00-5 | 2 |
| TIR5753191 | CARLISLE | 15X6.00-6 | 4 |
| TIRDS7055 | DEESTONE | 15X6.00-6 | 4 |
| TIR6L02651 | CARLISLE | 16X6.50-8 | 4 |
| TIR0864-918 | DEESTONE | 16X6.50-8 | 4 |
| TIRDS7060 | DEESTONE | 18X7.50-8 | 4 |
| TIR5753311 | CARLISLE | 18X8.50-8 | 4 |
| TIRDS7056 | DEESTONE | 18X8.50-8 | 4 |
| TIRDS7063 | DEESTONE | 18X9.50-8 | 4 |
| TIR5753411 | CARLISLE | 20X10.00-8 | 4 |
| TIR940112848 | BKT | 20X10.00-8 | 6 |
| TIR0814-918 | DEESTONE | 20X10.00-8 | 4 |
| TIR5753B7 | CARLISLE | 22.5X10.00-8 | 4 |
| TIR2251055030-4 | ACHIEVA | 22.5X10.00-8 | 4 |
| TIR50D3T7 | CARLISLE | 25X12.00-9 | 4 |
| TIR251298030-4 | ACHIEVA | 20X10.00-10 | 4 |
| TIR50D362 | CARLISLE | 20X10.00-10 | 4 |
| TIRDS7067 | DEESTONE | 20X10.00-10 | 6 |
| TIR5753151 | CARLISLE | 20X12.00-10 | 4 |
| TIR94012855 | BKT | 20X12.00-10 | 4 |
| TIR5753N11 | CARLISLE | 22X9.50-10 | 4 |
| TIR2295108030-4 | ACHIEVA | 22X9.50-10 | 4 |
| TIR2251088030-4 | ACHIEVA | 22.5X10.00-8 | 4 |
| TIR5753P2 | CARLISLE | 24X9.50-10 | 4 |
| TIR5753A61 | CARLISLE | 24X12.00-10 | 4 |

Pricing is subject to change.

TURF MASTER TIRES



Turf Master professional grade tires feature our most durable compound with deep tread lug profile optimized for stability and traction.

| PART # | BRAND | TIRE SIZE | PLY |
|----------------|----------|-------------|-----|
| TIR5112491 | CARLSTAR | 13X6.50-6 | 4 |
| TIR5112521 | CARLSTAR | 15X6.00-6 | 4 |
| TIR6L03071 | CARLSTAR | 15X6.50-8 | 4 |
| TIR5114011 | CARLSTAR | 16X6.50-8 | 4 |
| TIR5114021 | CARLSTAR | 16X7.50-8 | 4 |
| TIR5114171 | CARLSTAR | 18X6.50-8 | 4 |
| TIR5114041 | CARLSTAR | 18X8.50-8 | 4 |
| TIR5114131 | CARLSTAR | 18X9.50-8 | 4 |
| TIR5114051 | CARLSTAR | 20X10.00-8 | 4 |
| TIR5114281 | CARLSTAR | 20X8.00-10 | 4 |
| TIR5114161 | CARLSTAR | 20X10.00-10 | 4 |
| TIR511257 | CARLSTAR | 20X12.00-10 | 4 |
| TIR511256 | CARLSTAR | 22X10.00-10 | 4 |
| TIR5112551 | CARLSTAR | 22X11.00-10 | 4 |
| TIR511433 | CARLSTAR | 22X9.50-12 | 4 |
| TIR511419 | CARLSTAR | 23X8.50-12 | 4 |
| TIR2385128031 | ACHIEVA | 23X8.50-12 | 6 |
| TIR511406 | CARLSTAR | 23X9.50-12 | 4 |
| TIR5114081 | CARLSTAR | 23X10.50-12 | 4 |
| TIR23105128031 | ACHIEVA | 23X10.50-12 | 6 |
| TIR511434 | CARLSTAR | 24X9.50-12 | 4 |
| TIR5114091 | CARLSTAR | 24X12.00-12 | 4 |
| TIR2412128031 | ACHIEVA | 24X12.00-12 | 6 |
| TIR2612128031 | ACHIEVA | 26X12.00-12 | 6 |

ALL TRAIL II



- Designed specifically for use on hard surface and paved applications.
- Offers a smooth ride, more responsive handling and extra long life on hard surfaces compared to a standard knobby tire.

| PART # | BRAND | TIRE SIZE | PLY |
|------------------|----------|-------------------------------|-----|
| TIR55A3N1 | CARLSTAR | ALL TRAIL 22X9.50-10 | 4 |
| TIR55A3P2 | CARLSTAR | ALL TRAIL 24X9.50-10 | 4 |
| TIR55Z3N9 | CARLSTAR | ALL TRAIL 24X10.50-10 | 4 |
| TIR510043 | CARLSTAR | ALL TRAIL 20X10.00-8 | 4 |
| TIR510045 | CARLSTAR | ALL TRAIL 20X10.00-10 | 4 |
| TIR2295108028-4 | ACHIEVA | CAYMAN ALL TRAIL 22X9.50-10 | 4 |
| TIR510044 | CARLSTAR | ALL TRAIL 22X10.00-8 | 4 |
| TIR510016 | CARLSTAR | ALL TRAIL 22X11.00-10 | 4 |
| TIR22110108028-4 | ACHIEVA | CAYMAN ALL TRAIL 22X11.00-10 | 4 |
| TIR2251088028-4 | ACHIEVA | CAYMAN ALL TRAIL 22.5X10.00-8 | 4 |
| TIR511505 | CARLSTAR | ALL TRAIL 23X8.00-12 | 4 |
| TIR23105128028-4 | ACHIEVA | CAYMAN ALL TRAIL 23X10.50-12 | 4 |
| TIR511505 | CARLSTAR | ALL TRAIL 23X10.50-12 | 4 |
| TIR24105108028-4 | ACHIEVA | CAYMAN ALL TRAIL 24X10.50-10 | 4 |
| TIR511507 | CARLSTAR | ALL TRAIL 25X8.00-12 | 4 |
| TIR511508 | CARLSTAR | ALL TRAIL 25X10.50-12 | 4 |

ULTRA TRAC



The Ultra Trac is the right approach for those specialized applications where high flotation is essential. Ultra Trac tires are wide with a flat footprint and reduced void in the tread. These features yield low ground pressure and good traction while preserving the turf.

| PART # | BRAND | SIZE | PLY |
|-------------------|----------|-------------------|-----|
| TIR529368 | CARLSTAR | 24 X 13.00 - 12 | 4 |
| TIRP5042241312 | WANDA | 24 X 13.00 - 12 | 6 |
| TIR10507128BC1 | KENDA | 24 X 13.00 - 12 | 6 |
| TIR529387 | CARLSTAR | 24 X 13.00 - 12 | 6 |
| TIRT560626120014 | OTR | 26 X 12.00 - 14 | 6 |
| TIRT5604265140012 | OTR | 26.5 X 14.00 - 12 | 4 |
| TIR529386 | CARLSTAR | 26.5 X 14.00 - 12 | 4 |
| TIRP50422651412 | WANDA | 26.5 X 14.00 - 12 | 6 |
| TIR105071263C1 | KENDA | 26.5 X 14.00 - 12 | 6 |
| TIR529386 | CARLSTAR | 26.5 X 14.00 - 12 | 6 |
| TIRT560429140015 | OTR | 29 X 14.00 - 15 | 4 |
| TIRP5042291415 | WANDA | 29 X 14.00 - 15 | 6 |
| TIR5293F6 | CARLSTAR | 29 X 14.00 - 15 | 6 |
| TIR291415001 | OTR | 29 X 14.00 - 15 | 12 |



234 EQUIPMENT PARTS



AT489 TIRES

- Great shock absorption capabilities.
- Outstanding traction for both 2WD and 4WD applications.

| PART # | BRAND | SIZE | PLY |
|------------|----------|------------|-----|
| TIR5370461 | CARLSTAR | 22X10-10 | 4 |
| TIR5793N1 | CARLSTAR | 22X9.50-10 | 4 |
| TIR5893V0 | CARLSTAR | 22X11-10 | 4 |
| TIR589326 | CARLSTAR | 23X8-10 | 4 |
| TIR589327 | CARLSTAR | 23X10-10 | 4 |
| TIR589305 | CARLSTAR | 24X11-10 | 4 |
| TIR589308 | CARLSTAR | 25X11-10 | 4 |
| TIR589329 | CARLSTAR | 23X8-12 | 4 |
| TIR589330 | CARLSTAR | 23X10-12 | 4 |
| TIR589337 | CARLSTAR | 24X8-12 | 4 |
| TIR589342 | CARLSTAR | 24X9-12 | 4 |
| TIR589344 | CARLSTAR | 24X11-12 | 4 |
| TIR589335 | CARLSTAR | 25X10-12 | 4 |
| TIR589351 | CARLSTAR | 25X11-12 | 4 |
| TIR6P0371 | CARLSTAR | 27X9-12 | 6 |
| TIR6P0372 | CARLSTAR | 27X1-12 | 6 |



SAWTOOTH

| PART # | BRAND | TIRE SIZE | PLY |
|------------------|----------------|-------------|-----|
| TIRT1026E | GBC | 20.5X8.0-10 | 6 |
| TIRDS7108 | DEESTONE | 20.5X8.0-10 | 6 |
| TIR5193471 | CARLSTAR | 20.5X8.0-10 | 6 |
| TIR5193491 | CARLSTAR | 20.5X8.0-10 | 8 |
| TIR3-50-001-9830 | WANDA | 20.5X8.0-10 | 10 |
| TIRDS7110 | DEESTONE | 20.5X8.0-10 | 10 |
| TIR5193501 | CARLSTAR | 20.5X8.0-10 | 10 |
| TIRT1222S | GBC | 22.5X8.0-12 | 12 |
| TIR5190011 | CARLSTAR | 2.80-4 | 4 |
| TIR3-50-001-9653 | WANDA | 4.10-4 | 4 |
| TIRDS7200 | DEESTONE | 4.10-4 | 4 |
| TIR5190251 | CARLSTAR | 4.10-4 | 2 |
| TIR5190261 | CARLSTAR | 4.10-4 | 4 |
| TIR5190301 | CARLSTAR | 4.10-5 | 2 |
| TIR5190361 | CARLSTAR | 4.10-6 | 4 |
| TIR519067 | CARLSTAR | 5.30/4.50-6 | 6 |
| TIR5193171 | CARLSTAR | 4.80-8 | B |
| TIRDS7251 | DEESTONE | 4.80-8 | 6 |
| TIRT0856E | GBC | 4.80-8 | 6 |
| TIR5193181 | CARLSTAR | 4.80-8 | 6 |
| TIR5193191 | CARLSTAR | 5.70-8 | 4 |
| TIRDS7256 | DEESTONE | 5.70-8 | 6 |
| TIR5193201 | CARLSTAR | 5.70-8 | 6 |
| TIRDS7257 | DEESTONE | 5.70-8 | 8 |
| TIR6H01291 | CARLSTAR | 4.80-12 | 4 |
| TIRDS7266 | DEESTONE | 4.80-12 | 6 |
| TIR6H01301 | CARLSTAR | 4.80-12 | 6 |
| TIR6H01381 | CARLSTAR | 5.30-12 | 6 |
| TIRDS7271 | DEESTONE | 5.30-12 | 6 |
| TIRDS7272 | DEESTONE | 5.30-12 | 8 |
| TIR60106 | INDUSTRIAL ALL | 6.90-9 | 10 |



INDUSTRIAL TRAX TIRES

Designed for hard surface application and strength to hold up under heavy weight.

| PART # | BRAND | SIZE | PLY |
|----------------|----------|-----------------|-----|
| TIR560445 | CARLSTAR | 25 X 8.50 - 8 | 4 |
| TIR560446 | CARLSTAR | 25 X 10.50 - 12 | 4 |
| TIR103891200C1 | KENDA | 20 X 9.00 - 12 | 6 |
| TIR103891076C1 | KENDA | 20 X 10.00 - 10 | 6 |
| TIR599581 | CARLSTAR | 20 X 10.00 - 10 | 4 |



KNOBBY

The Knobby tire offers a unique design available in solid or dimple tread pattern. This tire is ideal for use in bunkers.

| PART # | BRAND | SIZE | PLY |
|-------------|----------|---------------|-----|
| TIR31200908 | CARLSTAR | 18 X 9.50 - 8 | 2 |
| TIR537050 | CARLSTAR | 22 X 11 - 8 | 2 |
| TIR537081 | CARLSTAR | 25 X 12 - 9 | 2 |

Pricing is subject to change.



GALAXY MIGHTY TOW TS

| PART # | BRAND | TIRE SIZE | PLY |
|-----------|--------|-------------|-----|
| TIR485040 | GALAXY | 16x6.50-8 | 4 |
| TIR485057 | GALAXY | 18x10.50-10 | 4 |
| TIR485047 | GALAXY | 18x8.50-10 | 4 |
| TIR485048 | GALAXY | 18x9.50-8 | 6 |
| TIR485073 | GALAXY | 20x10.00-8 | 4 |
| TIR485074 | GALAXY | 20x10.00-10 | 6 |
| TIR485532 | GALAXY | 22x11.00-10 | 4 |
| TIR485075 | GALAXY | 23x10.50-12 | 6 |
| TIR485076 | GALAXY | 24x12.00-12 | 4 |
| TIR485088 | GALAXY | 26x12.00-12 | 8 |



GALAXY MIGHTY MOW TURF TIRES

| PART # | BRAND | TIRE SIZE | PLY |
|-----------|--------|-------------|-----|
| TIR135259 | GALAXY | 10X16.5 | 8 |
| TIR135266 | GALAXY | 12X16.5 | 12 |
| TIR135433 | GALAXY | 17.5L24 | 8 |
| TIR135439 | GALAXY | 19.5L24 | 12 |
| TIR135249 | GALAXY | 21.5L16.1 | 6 |
| TIR135138 | GALAXY | 27X10.50-15 | 4 |
| TIR135141 | GALAXY | 27X8.50-15 | 6 |
| TIR135845 | GALAXY | 29X12.50-15 | 4 |
| TIR135343 | GALAXY | 41X14.00-20 | 4 |
| TIR135875 | GALAXY | 44X18.00-20 | 4 |
| TIR135223 | GALAXY | 9.5-16 | 6 |



GALAXY TURF SPECIAL

| PART # | BRAND | SIZE | PLY |
|-----------|--------|----------------|-----|
| TIR480232 | GALAXY | 12/L16 | |
| TIR401655 | GALAXY | 21.5/L16.1H | 16 |
| TIR480250 | GALAXY | 22.5/L16.1C | 6 |
| TIR480150 | GALAXY | 25/10.50L15C | 6 |
| TIR480151 | GALAXY | 27/10.50L15C | 6 |
| TIR480158 | GALAXY | 27/12L15C | 6 |
| TIR480243 | GALAXY | 33/16LL16.1E | 10 |
| TIR480247 | GALAXY | 33/18L16.1E | 10 |
| TIR480246 | GALAXY | 41/18.00L16.1C | 6 |
| TIR480373 | GALAXY | 41/18.00L22.5G | 14 |



GARDEN PRO R3 PRO

| PART # | BRAND | SIZE | PLY |
|-----------|--------|------------|-----|
| TIR579726 | GALAXY | 125/90R22 | 8 |
| TIR579728 | GALAXY | 170/100R38 | 8 |
| TIR579748 | GALAXY | 200/60R15 | 8 |
| TIR579689 | GALAXY | 200/65R16 | 8 |
| TIR579746 | GALAXY | 200/70R16 | 8 |
| TIR579750 | GALAXY | 220/55R12 | 8 |
| TIR579743 | GALAXY | 220/55R14 | 8 |
| TIR579751 | GALAXY | 240/60R12 | 8 |
| TIR579745 | GALAXY | 240/70R16 | 8 |
| TIR579754 | GALAXY | 260/70R16 | 8 |
| TIR579755 | GALAXY | 280/70R16 | 8 |
| TIR579756 | GALAXY | 280/70R18 | 8 |



STRAIGHT RIB

| PART # | BRAND | SIZE | PLY |
|-----------------|----------|-----------------|-----|
| TIR5181861 | CARLSTAR | 13 X 6.50 - 6 | 4 |
| TIRDS7226 | DEESTONE | 13 X 6.50 - 6 | 4 |
| TIR5180311 | CARLSTAR | 15 X 6.00 - 6 | 4 |
| TIRDS7227 | DEESTONE | 15 X 6.00 - 6 | 6 |
| TIRDS7211 | DEESTONE | 13 X 5.00 - 6 | 4 |
| TIR5180961 | CARLSTAR | 16 X 6.50 - 8 | 4 |
| TIRDS7221 | DEESTONE | 16 X 6.50 - 8 | 4 |
| TIR518081 | CARLSTAR | 18 X 9.50 - 8 | 4 |
| TIR5181161 | CARLSTAR | 20 X 10.00 - 10 | 4 |
| TIR94026128 | BKT | 20 X 10.00 - 10 | 4 |
| TIRT23105014002 | OTR | 23 X 10.50 - 14 | 4 |
| TIR510363 | CARLSTAR | 26 X 12.00 - 12 | 10 |



HD FIELD TRAX

Features a wide profile providing stability on hard-packed surfaces with its non-directional tread pattern and long-lasting construction. Delivers a smooth and comfortable ride while resisting cut, chips and abrasions.

| PART # | BRAND | TIRE SIZE | PLY |
|-----------|----------|------------|-----|
| TIR5883U1 | CARLSTAR | 18X8.50-10 | 4 |
| TIR5883B9 | CARLSTAR | 22.5X10-8 | 4 |
| TIR588389 | CARLSTAR | 22X12-8 | 4 |
| TIR588394 | CARLSTAR | 25X13-9 | 4 |
| TIR560467 | CARLSTAR | 26X12-12 | 4 |



236 EQUIPMENT PARTS

SMOOTH



| PART # | BRAND | SIZE | PLY |
|--------------------|-------|-------------|-----|
| TIR5120081 | CARLI | 8x3.00-4 | 4 |
| TIR5120101 | CARLI | 9x3.50-4 | 4 |
| TIR5100521 | CARLI | 11x6.00-5 | 4 |
| TIR5120211 | CARLI | 13x5.00-6 | 4 |
| TIRT5504135006 | OTR | 13x5.00-6 | 4 |
| TIR5121861 | CARLI | 13x6.50-6 | 4 |
| TIRT13656010 | OTR | 13x6.50-6 | 4 |
| TIR94013050 | BKT | 18x10.50-10 | 2 |
| TIR586310 | CARLI | 18x10.50-10 | 2 |
| TIR6L0149 | CARLI | 18x10.50-10 | 4 |
| TIRT550418105010 | OTR | 18x10.50-8 | 4 |
| TIRP60718958 | WANDA | 18x9.50-8 | 4 |
| TIR1895082886-4 | ACHIE | 18x9.50-8 | 4 |
| TIR074040856B1 | KENDA | 18x9.50-8 | 4 |
| TIR5109811 | CARLI | 18x9.50-8 | 4 |
| TIRT5504189508 | OTR | 18x9.50-8 | 4 |
| TIR074040869A1 | KENDA | 19x10.50-8 | 2 |
| TIRP607191058 | WANDA | 19x10.50-8 | 4 |
| TIR1910582886-4-TL | ACHIE | 19x10.50-8 | 4 |
| TIR586325 | CARLI | 20x10.00-10 | 2 |
| TIRT550220100010 | OTR | 20x10.00-10 | 2 |
| TIRP607201010 | WANDA | 20x10.00-10 | 4 |
| TIR084041077B1 | KENDA | 20x10.00-10 | 4 |

CH-23 DELUXE SYSTEM MANUAL TIRE CHANGER



The CH-22 & CH-23 Manual Tire Changing Station includes:

- CH-22 rim clamp plate – adjustable from 4" to 16.5", 2 center posts – to accommodate open hub and bearing wheels.
- CH-23 tire changer stand with adjustable bead breaker station and tire tool storage locations.
- Patented CH-4 Mongoose Tire Tool! The CH-4 Mongoose is the best tire tool ever made for changing difficult smaller tires thanks to its revolutionary design
- 2 Center Posts to accommodate multiple types of wheels.
- Floor mat for stability and safety

SHPCH2223

CH-22 MANUAL TIRE CHANGER

- Makes the job easy, fast and economical!
- Everything you need to change small tires and accommodates most wheels including open hub and bearing wheels.
- Includes the patented CH-4 Mongoose Tire Tool!

SHPCH22



Let Par West be your go-to rim and tire assembly supplier for your golf cart fleets! Call us to learn more about our available options.

GOLF CART TIRES & WHEELS

- Assemblies are tires mounted on rims with valve stem and fully inflated ready for use.

| PART # | SIZE |
|----------|--|
| NIV10990 | WHEEL ONLY - 8 X 7 CENTER - 4 HOLE - WHITE |
| NIV1608 | WHEEL ONLY- 8 X 7 CENTER - 4 HOLE - BEIGE |
| NIV14546 | 18 X 8.5-8 KENDA HOLE IN ONE TIRE ONLY |
| NIV41061 | 18 X 8.5-8 DURO TIRE ONLY |
| TIR1454A | KENDA TIRE W/ WHEEL MOUNT - WHITE |
| TIR4061A | DURO TIRE W/ WHEEL MOUNT - WHITE |

KENDA
ROUNDED EDGES
W/ SAWTOOTH TREAD



DURO
SAWTOOTH
TREAD



ADDITIONAL GOLF CART TIRE OPTIONS

| PART # | BRAND | SIZE | PLY |
|--------------------|----------|-------------|-----|
| TIR5192711 | CARLSTAR | 18X8.50-8 | 4 |
| TIR5189761 | CARLSTAR | 18X8.50-8 | 4 |
| TIRT0874C | GBC | 18.5X8.50-8 | 6 |
| TIRDS7106 | DEESTONE | 18.5X8.50-8 | 6 |
| TIR1885088036-GDRG | ACHIEVA | 18X8.50-8 | 6 |
| TIR5191461 | CARLSTAR | 205/50-10 | 4 |

FULL PALLET DISCOUNTS & FREE FREIGHT ON TIRES OR ASSEMBLIES

Pricing is subject to change.

PORTABLE AIR TANKS



SHPAT5 5 GALLON
SHPAT11 11 GALLON

TIRE INFLATOR



SHPTI

TUBELESS TIRE REPAIR KIT



- 1 X T-handle Spiral Probe Tool
- 1 X T-handle Insert Tool
- 1 X Tire Pressure Gauge, 40 X Self-Vulcanization Repair Plugs
- 4 X Black Extension Valves, 4 X Chrome Hex Valve Caps
- 4 X Plastic Valve Caps, 1 X 4-in-1 Valve Core Tool
- 4 X Standard Valve Cores, 1 X Folding Knife
- 1 X Plastic Storage Box, 1 X Blue Storage Case
- 2 X L-type Hex Tools, 1 X Jar of lubricant
- 1 X Pliers, 1 X User Manual

SHPTPK

TIRE CEMENT



SHPTC

TIRE PATCHES



- 56 patches included
- Patches come in various sizes
- Both round and rectangular patches
- Includes two tubes of rubber cement and two metal scuffers

SHPTPP

8" BRASS AIR BLOW GUN



SHPABG8

OSHA APPROVED AIR BLOW GUN



SHPABG18 18"
SHPABG24 24"

AIR BLOW NOZZLE



SHPABN

3 LB. DEAD BLOW MALLET



SHPDBM

2 LB. RUBBER MALLET



SHPRM2

PNEUMATIC GREASE GUN



SHPGGAP

GREASE GUN



SHPGGPG PISTOL GRIP
SHPGGLH LEVER ACTION

HITCH PINS



SHPHP12 1/2" X 4.75"
SHPHP58 5/8" X 4.75"
SHPHP34 3/4" X 4.75"

SPRING LOADED BALL JOINTS

- Use to connect reels or rollers to each other
- Spring loaded quick connect fittings
- Made to exceed oem specifications



SHP99-1460 FEMALE
SHP94-2958 MALE STUD





Trion's lift is ideally suited for the maintenance needs of golf course maintenance departments and recreation industry, servicing equipment that is commonly used in professional turf facilities. Optional attachments listed below to make repair jobs even easier.

PRO-M 9200 LIFT

TRI92000 COMPLETE LIFT
CRATING CHARGE

PRO-M WORKSTATION OPTIONS

- TRI8401** TOOL BAR EXTENSIONS (PAIR) REQUIRED TO LIFT AUTOMOBILES AND PICK UP TRUCKS
- TRI9104** INTERNATIONAL 220V/50HZ MOTER

UNIVERSIAL ATTACHMENT & ADAPTERS

For servicing mowing units. These hold units upside down for replacing bedknives. Can be purchased and added later.

MUST ORDER

- TRI8201** UNIVERSAL ATTACHEMENT
THEN SELECT ONE OR MORE BELOW:
- TRI8211** CUTTING UNITS (JACOBSEN 3810)
- TRI8212** TRIPLEX GREENSGROOMER CUTTING UNITS (JACOBSEN & TORO)
&
LIGHTWEIGHT FAIRWAY MOWER CUTTING UNITS (JACOBSEN & TORO)
- TRI8213** LIGHTWEIGHT FAIRWAY MOWER CUTTING UNITS (JACOBSEN & TORO)
- TRI8214** TORO RM5500, 650, & 6700
- TRI8215** TORO FLEX 21

OPTIONAL

- TRI8224** STORAGE STAND (STORES ADAPTERS ON PRO-M WORKSTATION)

TRION TURF EQUIPMENT LIFTS



DL-1300 MOBILE LIFT TABLE LIFT

Battery Not Included - Uses 12-Volt Lawn Mover Battery



TRIDL-1300 MOBILE LIFT STATION
CRATING CHARGE

ACCESSORIES

Convenience items can be purchased and added later

- TRI8230** SMALL WHEEL ADAPTERS (PAIR)
- TRI8301** ROLLING SHOP STOOL
- TRI8302** SCISSORS JACK
- TRI8304** QUICK OIL DRAIN W/ CASTERS
- TRI8305** POWER CORD REEL (115 VOLT)
- TRI8306** FLOURESCENT LIGHT REEL (115 VOLT)
- TRI8307** AIR HOSE REEL
- TRI8308** OIL DRAIN DOLLY
- TRI8309** HEAVY DUTY VEHICLE STAND
- TRI8310** OIL WASTE CAN
- TRI8311** PISTOL GREASE GUN
- TRI8312** AIR-OPERATED GREASE GUN
- TRI8313** LOW PRESSURE TIRE GAUGE
- TRI8314** WATER HOSE REEL

Pricing is subject to change.

REPLACEMENT SEATS



- Universal seats designed to fit most maintenance equipment and mowers
- Multiple bolt patterns allow easy mounting

- 1 SHPRSY** YELLOW UNIVERSAL SEAT
- 2 SHPRSG** GRAY UNIVERSAL SEAT
- 3 SHPRSB** BLACK UNIVERSAL SEAT
- 4 SHPRSY-P** YELLOW UNIVERSAL SEAT - PREMIUM BACK AND ERGONOMIC DESIGN
- 5 SHPRSG-P** GRAY UNIVERSAL SEAT - PREMIUM BACK AND ERGONOMIC DESIGN
- SHPRSGT** GREY TORO HDX WORKMAN ONLY SEAT W/ REAR STEEL BACK SUPPORT (NOT PICTURED ABOVE)

REPLACEMENT SEATS PARTS



- 6 SHPRS-SS** REPLACEMENT SAFETY SWITCH
- 7 SHPRS-RAIL** REPLACEMENT ADJUSTMENT RAILS

SEAT COVERS

Universal Fit

- SHPCY** YELLOW
- SHPCB** BLACK
- SHPCSC** CAMO



LED HEADLIGHTS

For Riding Mowers Or Equipment
27 Watt - 12 Volt



- SHPELLED** HEAD LIGHT W/ BRACKET
- SHPELHAR** WIRE HARNESS W/ ON/OFF SWITCH



LED LIGHT BARS

High Lighting Options
9-30 Volt



- SHPELBAR12** 12" STRAIGHT LIGHT BAR (72-WATT)
- SHPELBAR20** 20" STRAIGHT LIGHT BAR (126 WATT)
- SHPELBAR32** 32" STRAIGHT LIGHT BAR (180 WATT)
- SHPELBAR42** 42" CURVED LIGHT BAR (240 WATT)
- SHPELHAR** WIRE HARNESS KIT W/ ON/OFF SWITCH

SPILL CONTROL PALLETS

- Osha compliant secondary containment for drums
- Can be moved with forklift



- JUS28635 4 DRUM SQUARE
- JUS28631 4 DRUM IN LINE
- JUS28627 3 DRUM IN LINE
- JUS28623 2 DRUM
- JUS28688 RAMP

DRUM CRADLE



- Easily move drums or put them in a horizontal position to use drain valve

JUS08800 600 LB. CAPACITY

ACCUTECH JET RINSE NOZZLE



IRR17139 3/4" (FGHT) inlet

SPOTON NOZZLE CLEANER & TIP TOOL



TLT27860 50 PSI AIR BLAST

TOTE CONTAINMENT



- OSHA compliant secondary containment for totes
- Can be moved with forklift

JUS28674 372 GAL. CAPACITY

DRUM PUMP



- Screws onto any drum
- Pumps fertilizers, chemicals or wetting agents

SHPDP55 DRUM PUMP

SPILL CONTROL KIT



- Universal 30 gallon spill kit to ensure fast response
- This spill kit is packed with quality SpillTech products to help you clean up fast and comply with regulations
- Includes a variety of sorbents to handle spills of oils, coolants, solvents or water

SAFSPK30 SHOP SPILL KIT

OILY WASTE BINS



- JUS09100 6 GALLON RED
- JUS09101 6 GALLON YELLOW
- JUS09300 10 GALLON RED
- JUS09301 10 GALLON YELLOW
- JUS09700 21 GALLON RED
- JUS09701 21 GALLON YELLOW

HEAVY DUTY TARPS



SHPBC6 \$10.00
6" BUNGEE WITH BALL - PACK OF 10

- SHPTHD10X12 9.4' x 11.4'
- SHPTHD15X20 14' x 20'
- SHPTHD20X30 19' x 29.4'
- SHPTHD30X40 28.10' x 39.4'



POWERBLAST 3000 ALL-IN-ONE ELECTRIC PRESSURE WASHING UNIT - 110V, 3000 PSI



This first is a pressure washer/reel combination wall mounted unit that is very unique in the marketplace. I see this as a great item for golf courses in both the cart barn and the maintenance shop. Here are the features:

- 3000 PSI working pressure
- 1.20 GPM flow rate – saves water compared to standard hose with high pressure nozzle
- Industrial motor durable enough for commercial daily use and high longevity
- Self-contained unit includes mounted pressure washer gun, 4 spray tips, wand, and foam cannon
- 110-volt unit plugs directly into standard outlet for easy use
- Comes complete with leader hose – unit is ready to go out of the box with everything you need
- Choose from a stand-alone unit or enhance your setup with a spring-loaded reel available in 50 ft or 100 ft lengths

- IRRPW-3000** PRESSURE WASHER HEAD ONLY
- IRRPW-3000-INT** PRESSURE WASHER HEAD ONLY (INT VERSION)
- IRRPW-3000-50** PRESSURE WASHER W/ 50' HOSE REEL
- IRRPW-3000-50-IN** PRESSURE WASHER W/ 50' HOSE REEL (INT VERSION)
- IRRPW-H14-050** 50' HOSE ONLY
- IRRPW-R-50** 50' HOSE REEL ASSEMBLY ONLY
- IRRPW-GUN** PRESSURE WASHER GUN
- IRRPW-NZ-PS** PROSPRAY PRESSURE WASHER NOZZLE
- IRRPW-NZ-PM** PATTERN MASTER 6-IN-1 PRESSURE WASHER NOZZLE
- IRRPW-W-18** 18" PRESSURE WASHING WAND



50' or 100' Foot Hose



Pressure Washer Gun



ProSpray Pressure Washer Nozzle



Pattern Master 6-in-1 Pressure Washer Nozzle

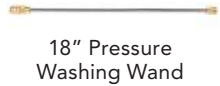

18" Pressure Washing Wand

SPRAY R-15 AR STYLE PRESSURE WASHER

- AR style Pressure Washer Handle
- Make Washing fun again!
- Shoulder Stock provides comfort when washing for long periods of time
- Max Pressure 5000PSI / 350 Bar
- Includes: Pressure washer gun, additional orange tip barrel extender, 5 Spray tips, & M22-14mm Adapter
- Compatible with standard 1/4" connectors and foam cannons or Hose Cannon below.



Disclaimer: This is a pressure washing gun designed to look like an AR rifle. This is NOT a real AR15 rifle. Please take caution when using. Use in a safe location and handle with care.

WRAR001



MOWER UNDERCARRIAGE PRESSURE WASHER WAND



SHPUCW



HOSE CANNON

Kit Includes Foam Cannon And Trigger Nozzle

- Covers large surfaces in seconds making washing a breeze
- Features a robust plastic reservoir and high quality brass components
- Can be adjusted for vertical and horizontal spray patterns
- Adjustable dilution dial for maximum control over the concentration of your wash
- Simple coupling connection to water supply
- Fits any 5/8" and 3/4" standard garden hose



WRTW0013

Pricing is subject to change.

TURF & LANDSCAPE CANNON KITS
Kit Includes 1 Cannon & 2 Cartridges



- Total wash is the total package when it comes to cleaning and degreasing your equipment
- The non-corrosive formula will quickly remove bugs, brake dust, oil, mud and clay
- Safe to use on soft metals such as aluminum or anodized components
- Total wash is biodegradable and provides a perfect clean without leaving a residue or water spots
- One Cartridge makes 5 gallons of wash
- If not using with a Total Wash Cannon dilute at a 20:1 ratio
- Connects to standard 1/4" pressure washer

WRTW0003 SINGLE KIT
WRTW0003-6 CASE OF 6

TURF & LANDSCAPE CANNON CARTRIDGE



- Total wash is the total package when it comes to cleaning and degreasing your toys
- One bottle makes 5 gallons of wash and can be used with a Total Wash Cannon or diluted with water and applied manually.
- The non-corrosive formula will quickly remove bugs, brake dust, oil, mud and clay
- Biodegradable and safe to use on soft metals such as aluminum or anodized components

WRTW0008 SINGLE CARTRIDGE
WRTW0008-12 CASE OF 12

HEAVY DUTY



- Total wash a strong formula that cuts through oily grime, brake dust, & bug guts with ease.
- Is virtually touchless which means you can throw away your brushes and let the cleaner work for you.
- Easily cleans tires for a deep black finish
- Safe to use on any wheel type
- Great for engine degreasing
- Breaks down bug guts and debris for easy removal
- Acid free

WRTW0015 SINGLE BOTTLE
WRTW0015-16 CASE OF 16

MUD DEFENDER



- Mud release agent that reduces the sticking and clean up of heavy soils, mud, rubber, and clay
- Thick protective coating that leaves a high gloss finish
- Great for use on plastic, metal, rubber, vinyl, and carbon fiber
- Advanced non-silicone technology

WRMD0001 SINGLE CAN
WRMD0001-12 CASE OF 12

F3 - FAST FOAM AIR FILTER CLEANER 320G



- Completely cleans from start to finish quickly!
- Works effectively on Petroleum and Biodegradable filter oils.
- Smells Great, Biodegradable, and Non-flammable
- Self-activating soap when rinsing out in water
- Safe on glue joints and the foam itself
- Doubles as a highly effective air-box cleaner!

WRF30005 SINGLE CAN
WRF30005-12 CASE OF 12

HYDRACOAT QUICK DETAILER



- Gently loosens and lifts dust, pollen, finger prints, and light grime
- Delivers a rich deep lustrous looking finish while achieving a dry anti-static coating
- Cleans shines and Protects all automotive Surfaces
- Hydro Coat technology leaves a long lasting durable hydrophobic coating
- Highly effective for both interior and exterior use

WRHC0001 SINGLE BOTTLE
WRHC0001-16 CASE OF 16



244 MAINTENANCE SHOP SUPPLIES



- | | |
|--------------------------------|----------------------------------|
| JUS7210120 1 GAL RED | JUS7225120 2.5 GAL RED |
| JUS7210220 1 GAL YELLOW | JUS7225220 2.5 GAL YELLOW |
| JUS7210320 1 GAL BLUE | JUS7225320 2.5 GAL BLUE |
| JUS7210420 1 GAL GREEN | JUS7225420 2.5 GAL GREEN |
| JUS7220120 2 GAL RED | JUS7250120 5 GAL RED |
| JUS7220220 2 GAL YELLOW | JUS7250220 5 GAL YELLOW |
| JUS7220320 2 GAL BLUE | JUS7250320 5 GAL BLUE |
| JUS7220420 2 GAL GREEN | JUS7250420 5 GAL GREEN |

These are "Safety Cans" which are FM approved, UL Listed, CARB & OSHA compliant, and are required by OSHA when used by any business or commercial enterprise. Key required safety features include flame arresters, self-closing lids, pressure relief, and 100% leak testing.

TYPE II SAFETY GAS & DIESEL CANS



AVOID OSHA FINES
No Plastic Cans

LITHIUM ION BATTERY CHARGING STORAGE CABINET

Call For Pricing

Introducing Justrite's lithium-ion battery charging and storage cabinet, fortified with ChargeGuard™ for ultimate protection. This state-of-the-art cabinet features multiple layers of advanced shielding, specifically designed to reduce the risks of battery fires and thermal runaway.

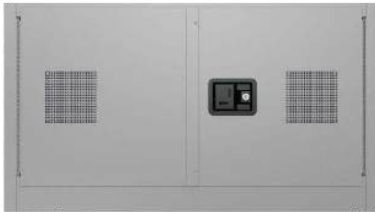

Charge and store your new Echo eForce Lithium-Ion Batteries!



OUTDOOR SAFETY CABINETS

Call For Pricing



FLAMMABLE MATERIAL STORAGE

30 Gal, 1 Shelf



- 1 shelf, 30 gallon capacity
- Self closing doors
- Meets all OSHA requirements

- | | |
|------------------|---------------|
| JUS893020 | YELLOW |
| JUS893021 | RED |

FLAMMABLE MATERIAL STORAGE

90 Gal, 2 Shelf



- 2 shelves, 90 gallon capacity
- Self closing doors
- Meets all OSHA requirements

- | | |
|------------------|---------------|
| JUS899000 | YELLOW |
| JUS899001 | RED |

WALL MOUNTED FLAMMABLE CABINET



- 3 shelves, 20 gallon capacity
- 2 Self closing doors
- Meets all OSHA requirements

- | | |
|------------------|---------------|
| JUS893400 | YELLOW |
|------------------|---------------|

Pricing is subject to change.

COMMERCIAL FENCE PRIVACY SCREENING

High-Quality Material Includes Grommets and Fasteners

CLUBHOUSE SERIES SCREEN

DURABLE PRODUCT FOR ATHLETIC FIELDS AND TENNIS COURTS

- 5 Year warranty & 8-10 year expected life
- 95% Privacy with the highest level of uv inhibitors
- 400-Gsm, tight knit woven polypropylene with no fillers for ultimate strength and excellent visibility blockage
- Reinforced edges with black binding & stimpson brass military-grade grommets spaced every 24" on all sides
- Custom sizes, colors and wind holes available by special order



50 Foot Sections - Includes Grommets & Fasteners

| PART # | FENCE HEIGHT | COLOR |
|-------------|--------------|-------|
| FS750450-GN | 4 FEET | GREEN |
| FS750550-GN | 5 FEET | GREEN |
| FS750650-GN | 6 FEET | GREEN |
| FS750850-GN | 8 FEET | GREEN |
| FS750450-BK | 4 FEET | BLACK |
| FS750550-BK | 5 FEET | BLACK |
| FS750650-BK | 6 FEET | BLACK |
| FS750850-BK | 8 FEET | BLACK |

MAINTENANCE SERIES SCREEN

- 90% Privacy & airflow blockage
- Commercial grade material: 175 g/m2 (25% higher than competitors)
- Proprietary heat set process, will not shrink on fence
- Optimum uv additives for weathering protection
- 300-Gsm black binding & solid brass grommets every 24"
- 3 - 5 Year expected life, any climate
- Custom sizes, colors and wind holes available by special order



COLOR OPTIONS



50 Foot Sections - Includes Grommets & Fasteners

| PART # | FENCE HEIGHT | COLOR |
|--------------|--------------|------------|
| FS200450-GN | 4 FEET | GREEN |
| FS200550-GN | 5 FEET | GREEN |
| FS200650-GN | 6 FEET | GREEN |
| FS200850-GN | 8 FEET | GREEN |
| FS200450-BK | 4 FEET | BLACK |
| FS200550-BK | 5 FEET | BLACK |
| FS200650-BK | 6 FEET | BLACK |
| FS200850-BK | 8 FEET | BLACK |
| FS200450-BR | 4 FEET | BROWN |
| FS200550-BR | 5 FEET | BROWN |
| FS200650-BR | 6 FEET | BROWN |
| FS200850-BR | 8 FEET | BROWN |
| FS200450-TAN | 4 FEET | DESERT TAN |
| FS200550-TAN | 5 FEET | DESERT TAN |
| FS200650-TAN | 6 FEET | DESERT TAN |
| FS200850-TAN | 8 FEET | DESERT TAN |

TERMS & CONDITIONS

PAYMENT METHODS

- Net 30 days - on approved credit
- Payment by mail - We accept Money Orders, Cashier Checks, Company and Personal Checks (allow 7-10 working days for check clearance by Bank). Please make all payment payable to Par West Turf Services and mail payment to:

PAR WEST TURF SERVICES
17952 LYONS CIRCLE
HUNTINGTON BEACH, CA 92647

- Credit card payment - we accept visa, mastercard or American Express payments. If a credit card is used for payment after the due date of an invoice, a 3.5% surcharge will be added.
- Bank wire transfer or paypal - please contact us with questions about these payment methods.

PRICING AND INFORMATION DISCLAIMER

All pricing subject to change without notice. All product measurements are approximate.

PAYMENT TERMS, INTEREST, COLLECTION FEES

Terms of payment are within Par West Turf Services' sole discretion. Invoices are due and payable within the time period noted on the invoice, measured from the date of the invoice. Par West Turf Services Inc. may invoice parts of an order separately. Customer agrees to pay interest on all past due sums at the highest rate allowed by law. The Customer is responsible for sales and all other taxes associated with the order. Any legal costs associated with the collection of invoices will be the responsibility of the customer.

ITEM SPECIFICATIONS

There may be times where Par West Turf Services changes the source of an item for various reasons. Par West Turf Services, at its discretion, reserves the right to substitute an item in the catalog for an equal or better item.

SHIPPING

- Shipping; Title; Risk of Loss. Title to Product and/or Equipment will pass from Par West Turf Services or Par West Turf Services' suppliers to Customer on shipment from Par West Turf Services' facilities or other designated third party supplier's facility. Loss or damage that occurs during shipping by a carrier selected by Par West Turf Services is Par West Turf Services' or Par West Turf Services' supplier's responsibility. Loss or damage that occurs during shipping by a carrier selected by Customer is Customer's responsibility. Par West Turf Services reserves the right to make delivery of Product and/or Equipment in installments.
- In the event the shipment has not been received within 14 days of the billing (hard charge) to the credit card, the customer must contact Par West Turf Services so a tracer can be initiated on the shipment.
- Overnight Shipping. Customers may choose FedEx Standard or Priority Overnight Service or 2 Day for an additional fee.
- International Shipping. Orders outside the USA are subject to import charges, taxes and freight charges which are the responsibility of the purchaser. Contact customer service for more information.
- It is the customer's responsibility to check the packing slip of a shipment and notify Par West of any discrepancy within 5 days of delivery.
- All pricing is f.o.b. shipping point unless otherwise stated.

RETURNS

OUR 30 DAY NO HASSLE RETURN POLICY

- In the event you wish to return an item, please contact us via phone at 714-893-1555, email us at customerservice@parwest.com or through our website to obtain to RMA number to get the return process started.
- Once an RMA number is obtained, if needed we will email you a return label for returned merchandise. Simply hand the UPS or FedEx driver the box with the label attached to it to return the product.
- Credits and/or refunds will be given when the return shipment reaches our warehouse, and we will reach out to you to confirm your return. Only products in unused and non-damaged condition may be returned for credit.
- Please note that for oversized boxes we cannot refund the original shipping costs and you will still need to pay original shipping.
- Returns may be subject to restocking fees and return shipping charges.
- Items received after 30 days are only given account credit with Par West, we cannot refund money on items that are past our 30-day policy.
- All products we sell are covered under their respective manufacturer's warranties. If you feel you have a warranty issue – reach out to us and we will help you work it out with the item's manufacturer.
- Custom orders cannot be returned or refunded. Custom orders require proof approval to ensure item is accurate and approved proof is confirmation of the order.
- Items not returned through our returns policy process above may not be credited to you or may be returned to you.

We Want Every Customer to Have a Positive Experience With Us.

If for Any Reason Your Experience Did Not Meet That Standard, Please Reach Out to Us and We Will do Our Best to Resolve the Issue. We Greatly Appreciate Your Business.



PAR WEST TURF SERVICES INC.
17952 LYONS CIRCLE
HUNTINGTON BEACH, CA 92647

833-232-3365 - TOLL FREE
714-893-1555 - SALES/CUSTOMER SERVICE
714-893-1575 - FAX
SALES@PARWEST.COM
WWW.PARWEST.COM

